

DATASHEET

Lutosa

SRFL061 • flexiANT[®]



Features

- Antenna for 5G cellular applications
- High performance: DFI (Designed For Integration)
- 1.13mm diameter RF cable with I-PEX MHF connector
- Self-adhesive mounted, does not require matching
- Quick integration minimizes design cycle
- 100mm or 150mm cable – (other lengths available, MOQs apply)
- Horizontal (in-line) cable
- Supports Band 74 (1420-1520MHz)
- High Efficiency (which assists with PTCRB certification)

Contents

1.	Description	2
2.	Applications	2
3.	General data	2
4.	Part number	3
5.	RF characteristics	3
6.	RF performance	4
6.1.	Return loss	4
6.2.	VSWR	4
6.3.	Antenna pattern	5
7.	Antenna dimensions	13
7.1.	Dimensions FPC section	13
7.2.	Dimensions assembled	13
7.3.	I-PEX connector MHF1 (20278-112R-13)	14
7.4.	Assembly	14
8.	Electrical interface	15
8.1.	Host interface	15
8.2.	Transmission line	15
9.	Mechanical fixing	15
10.	Antenna integration guide	16
10.1.	Antenna placement	16
10.2.	Orientation of FPC	17
11.	Hazardous material regulation conformance	18
12.	Packaging	18
12.1.	Optimal storage conditions	19
12.2.	Label information	19

1. Description

A flexible antenna with cable enables direct connection to the host PCB for easy integration. The antenna covers the most common 5G bands: B71 (617-698MHz), LTE 700, GSM850, GSM900, DCS1800, PCS1900, WCDMA2100, LTE B7 (2500-2690MHz), B74 (1420-1520MHz), LTE B40 (2300 – 2400MHz) and 5G B78 (3300-3800MHz).

2. Applications

- Network devices such as cellular routers
- Pico base-stations
- Remote monitoring
- POS (Point of Sale) terminals
- M2M (Machine to Machine)
- IoT (Internet of Things)
- CCTV (Closed Circuit TV) over cellular
- Drone communications

3. General data

FREQUENCY	617-698MHz 698-824MHz 824-960MHz 1420-1520MHz 1710-2200MHz 2300-2400MHz 2500-2690MHz 3300-3800MHz
POLARIZATION	Linear
OPERATING TEMPERATURE	-40°C to +85°C
ENVIRONMENTAL CONDITION TEST	ISO16750-4 5.1.1./5.1.2
IMPEDANCE	50 Ω
WEIGHT	<0.5g
ANTENNA TYPE	FPC Self-adhesive 3M 468MP
DIMENSIONS (ANTENNA)	95.0 x 15.0 x 0.15 (mm)
CONNECTION	I-PEX MHF1 (20278-112R-13)

4. Part number

LUTOSA
SRFL061

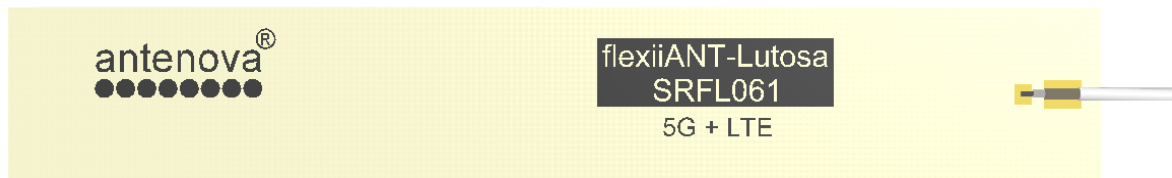

5. RF characteristics

	617-698MHZ	698-824MHZ	824-960MHZ
PEAK GAIN	-1.7dBi	1.7dBi	1.7dBi
AVERAGE GAIN (LINEAR)	-4.2dBi	-3.2dBi	-2.3dBi
AVERAGE EFFICIENCY	>40%	>45%	>55%
MAXIMUM RETURN LOSS	-6dB	-5dB	-11dB
MAXIMUM VSWR	2.9:1	3.1:1	1.6:1

	1420-1520MHZ	1710-2200MHZ	2300-2400MHZ
PEAK GAIN	1.9dBi	2.7dBi	3.6dBi
AVERAGE GAIN (LINEAR)	-2.2dBi	-2.1dBi	-1.8dBi
AVERAGE EFFICIENCY	>60%	>60%	>65%
MAXIMUM RETURN LOSS	-11dB	-8dB	-13dB
MAXIMUM VSWR	1.7:1	2.1:1	1.5:1

	2500-2690MHZ	3300-3800MHZ
PEAK GAIN	3.7dBi	3.6dBi
AVERAGE GAIN (LINEAR)	-1.9dBi	-2.2dBi
AVERAGE EFFICIENCY	>65%	>60%
MAXIMUM RETURN LOSS	-9dB	-7dB
MAXIMUM VSWR	2.0:1	2.4:1

All data measured on SRFL061-150 in a loaded condition adhered to a plastic carrier in free space.

6. RF performance

6.1. Return loss

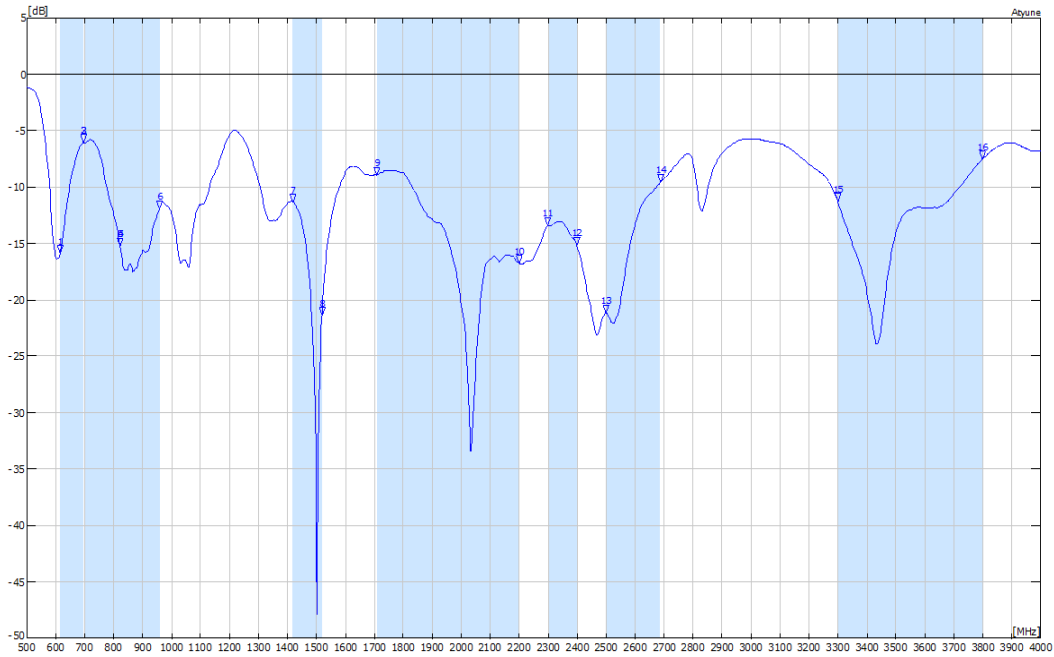

6.2. VSWR

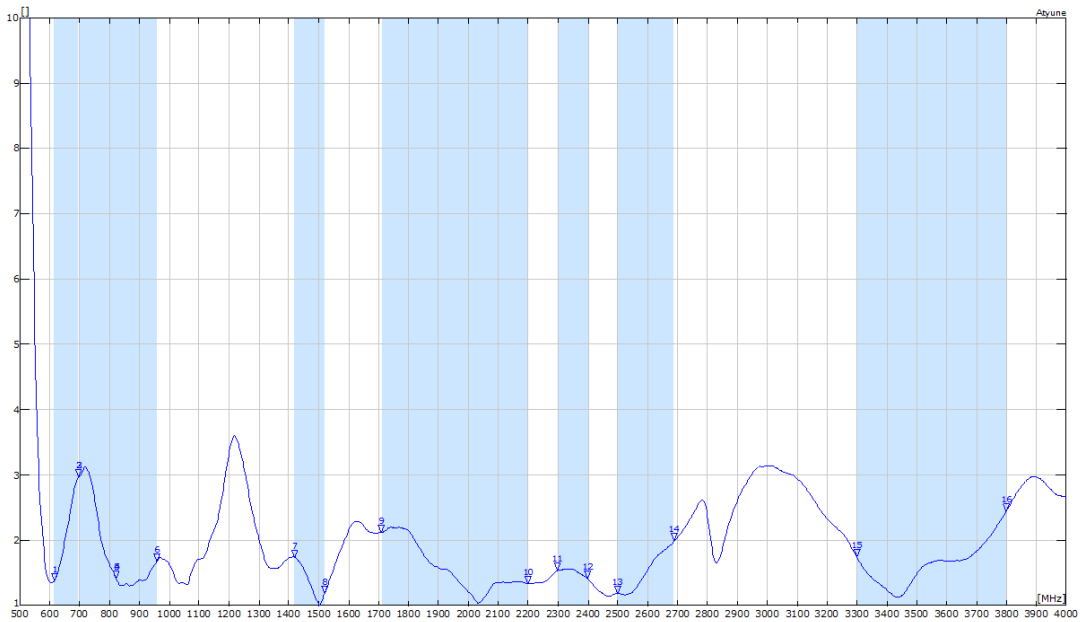

All data measured on SRFL061-150 in a loaded condition adhered to a plastic carrier in free space.

6.3. Antenna pattern

6.3.1. 617 MHz – 698 MHz

3D pattern at 657MHz

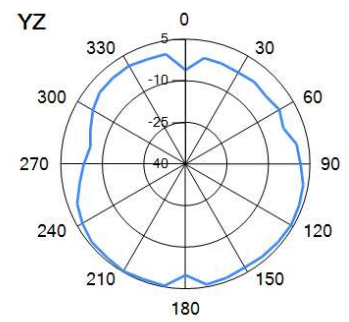
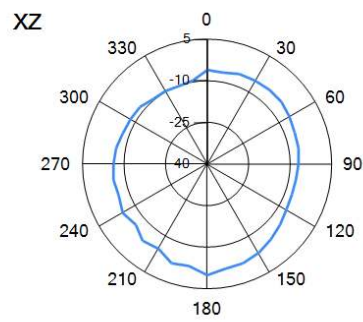
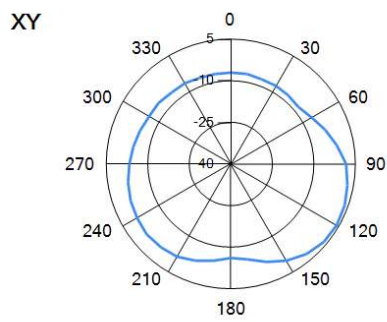
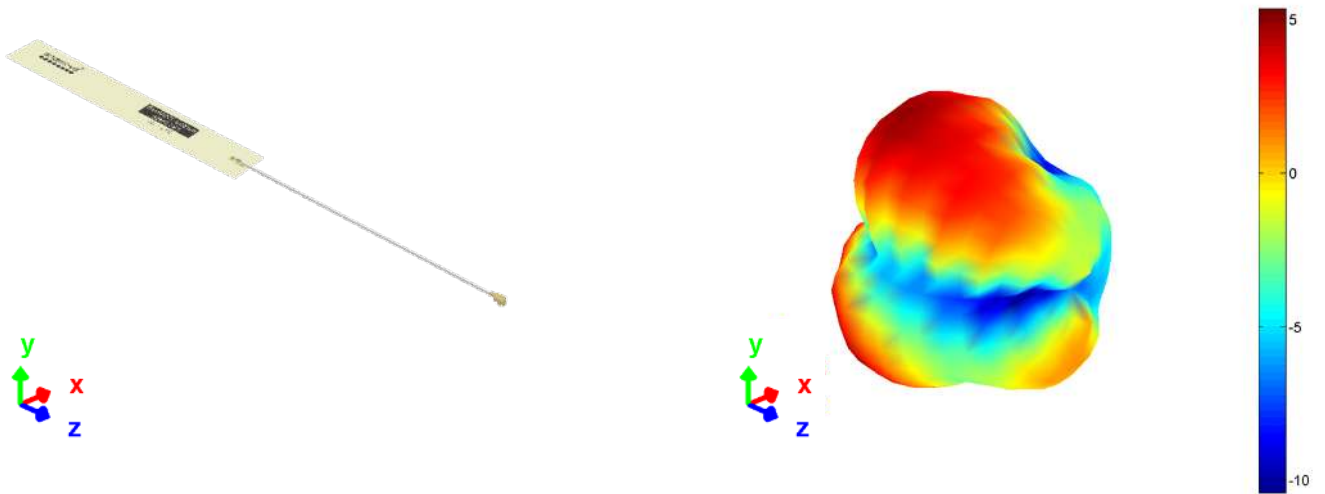

6.3.2. 698 MHz – 824 MHz

3D pattern at 764MHz

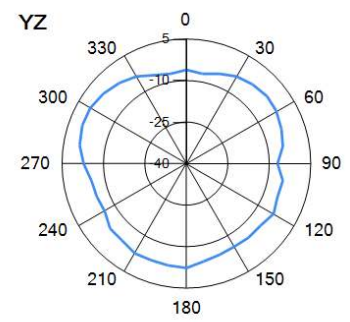
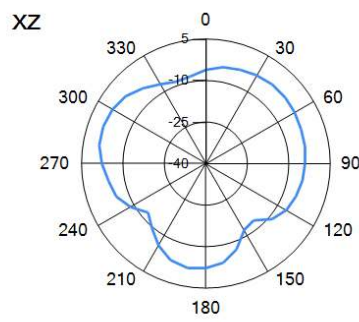
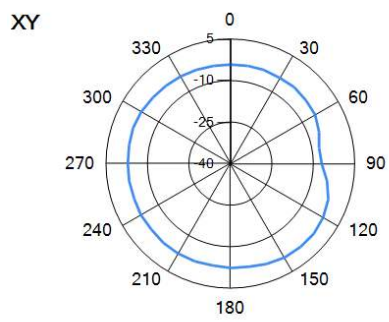
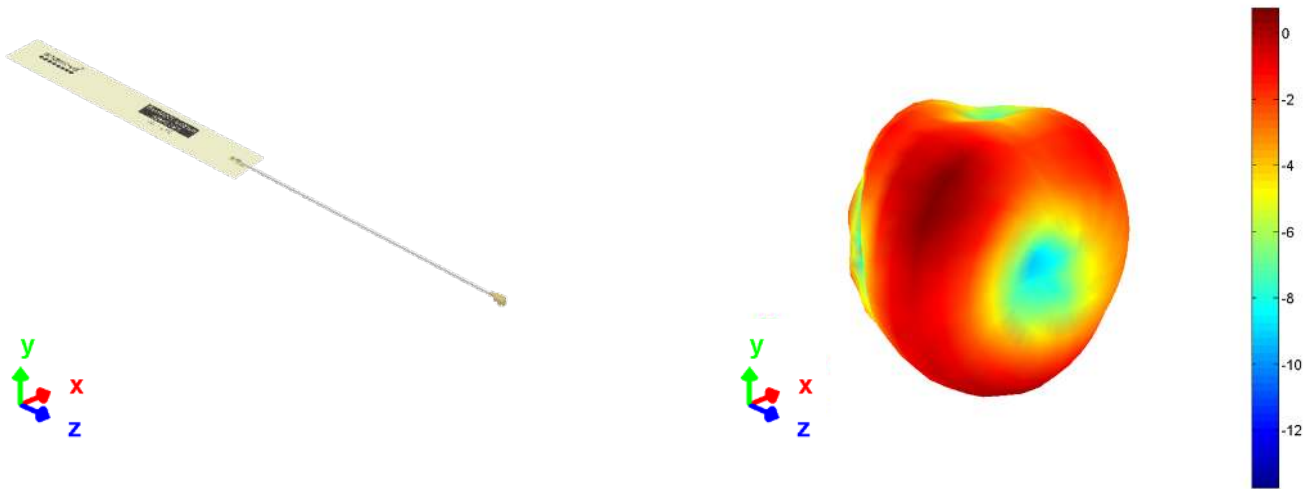

— 764MHz

6.3.3. 824 MHz – 960 MHz

3D pattern at 900MHz

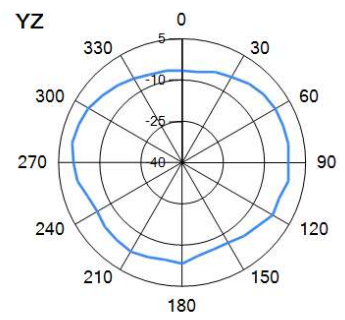
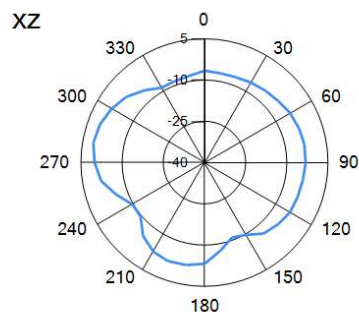
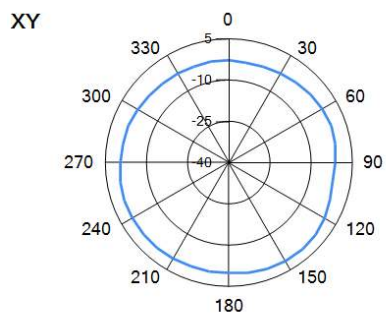
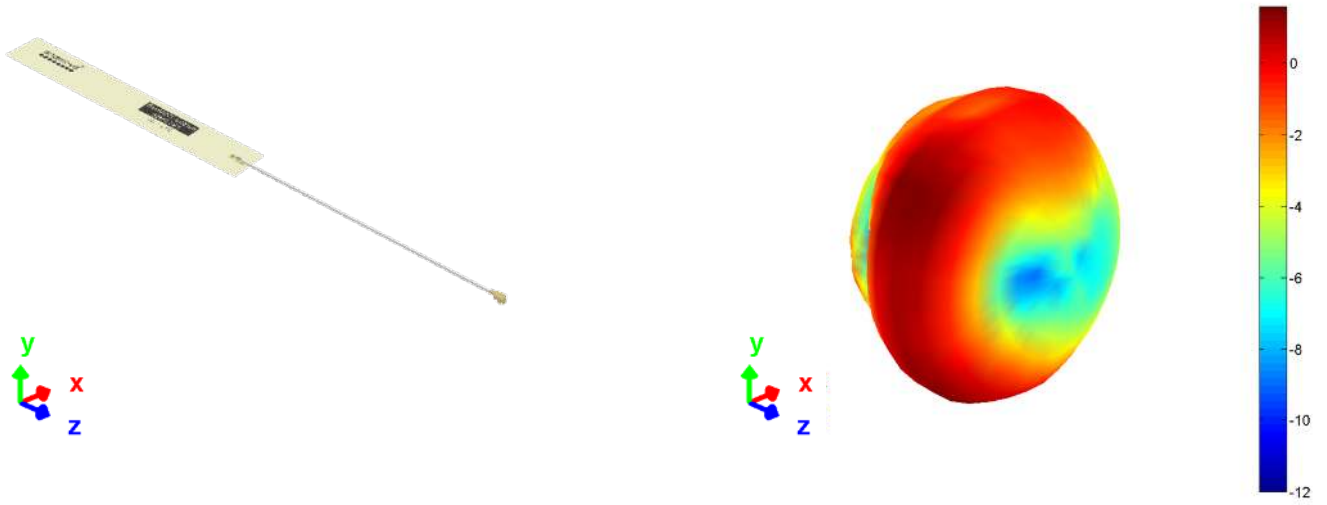

— 900MHz

6.3.4. 1420 MHz – 1520 MHz

3D pattern at 1470MHz

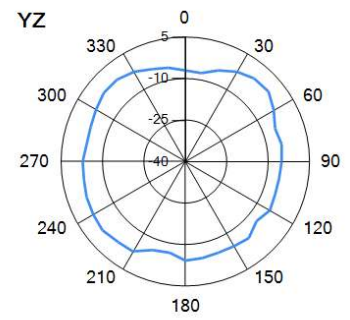
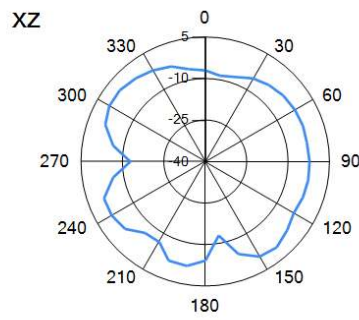
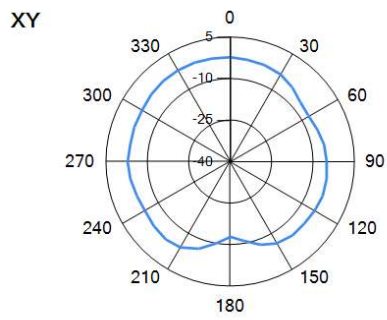
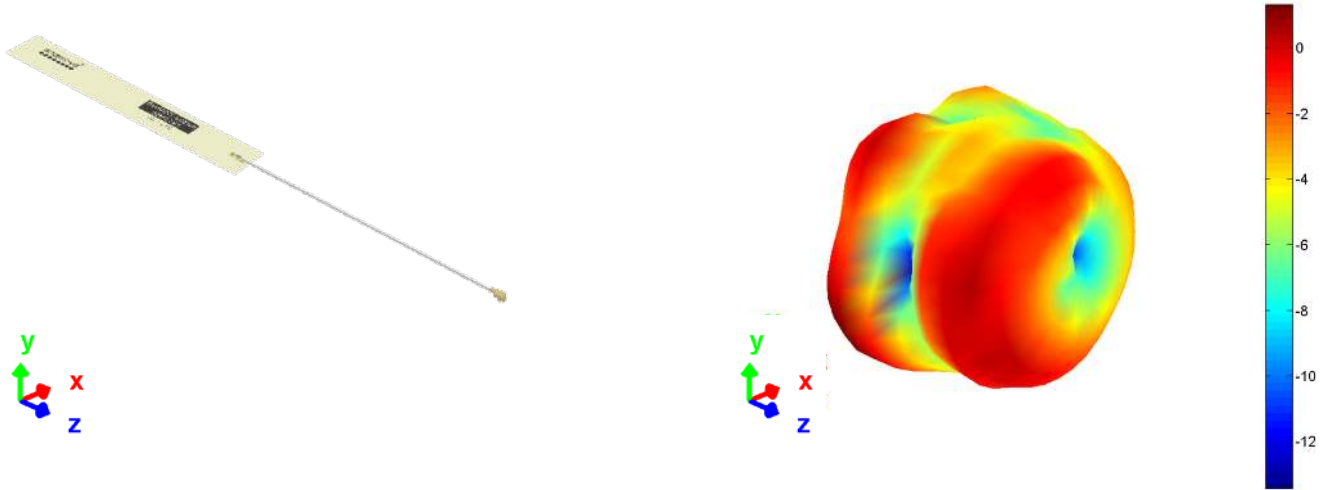

— 1.47GHz

6.3.5. 1710 MHz – 2200 MHz

3D pattern at 1930MHz

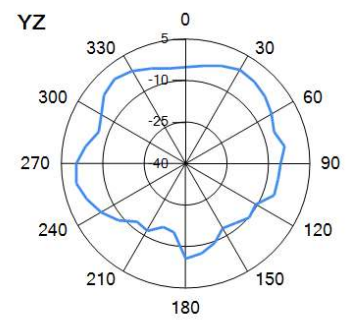
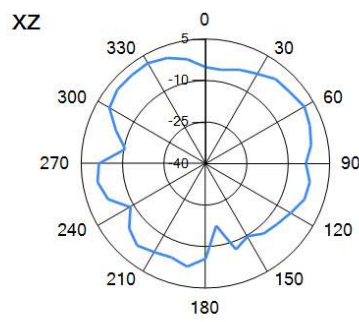
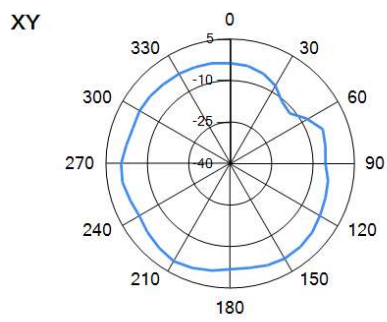
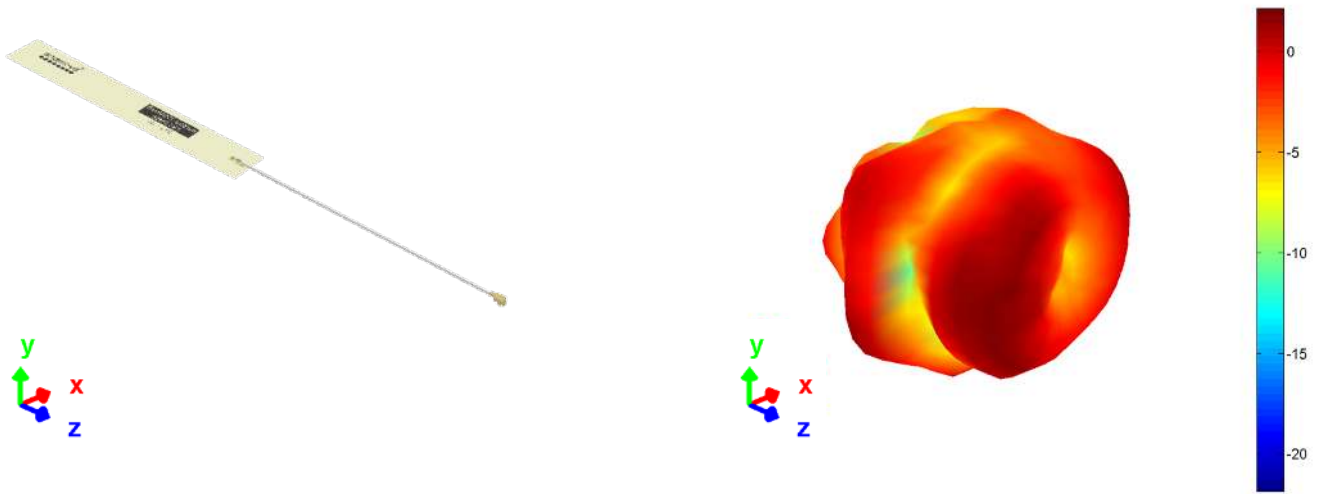

— 1.93GHz

6.3.6. 2300 MHz – 2400 MHz

3D pattern at 2340MHz

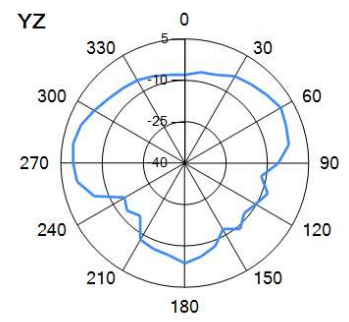
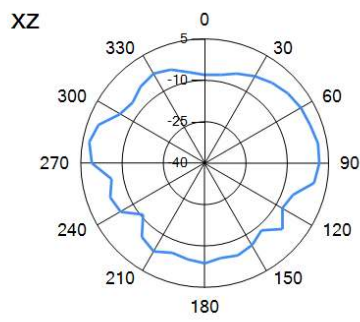
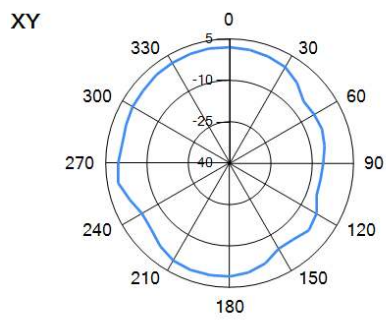
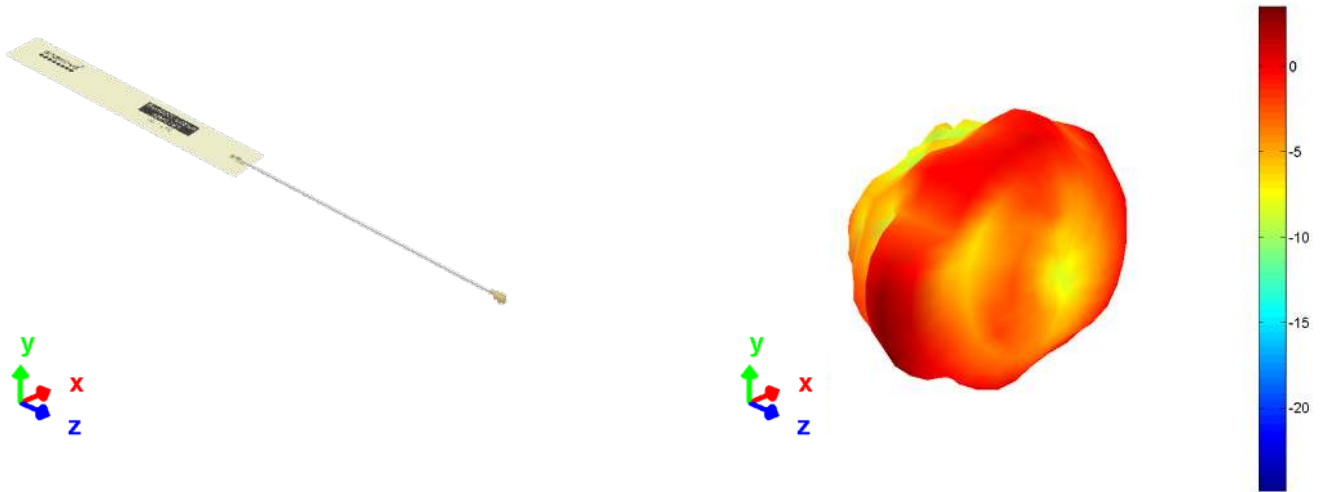

— 2.34GHz

6.3.7. 2500 MHz – 2690 MHz

3D pattern at 2600MHz

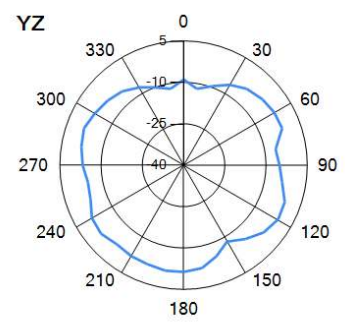
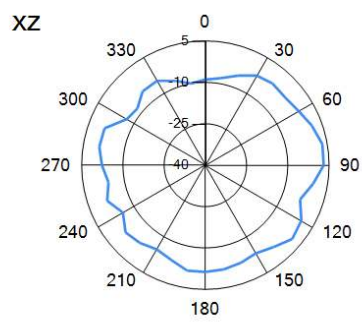
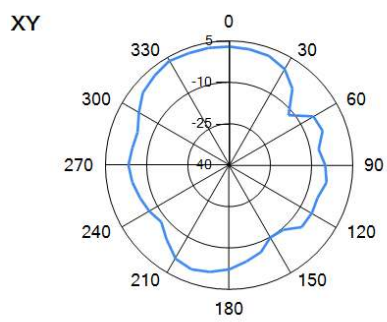
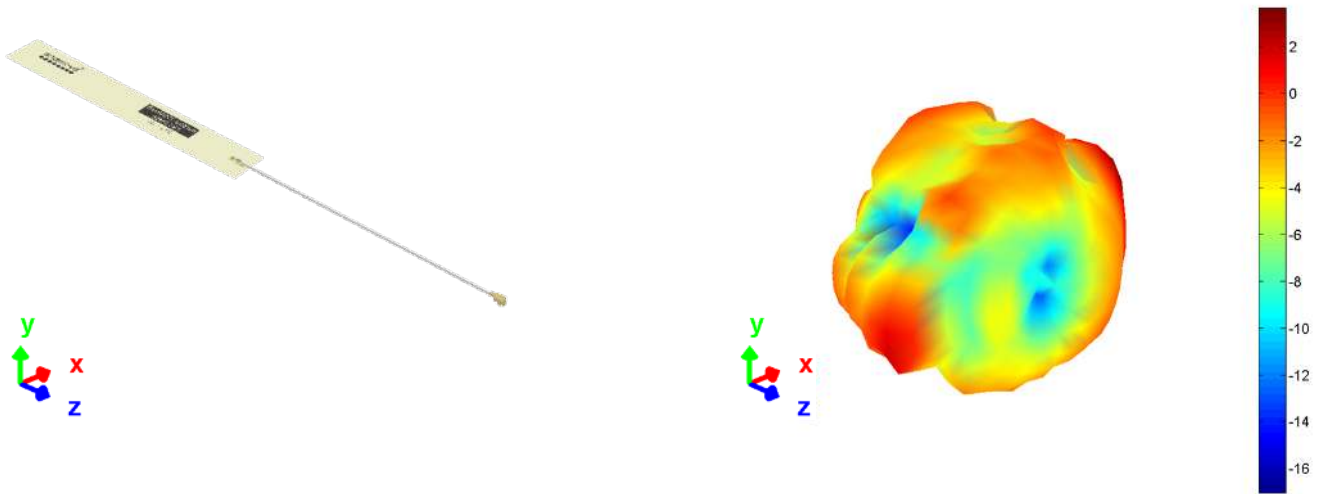

— 2.6GHz

6.3.8. 3300 MHz – 3800 MHz

3D pattern at 3540MHz

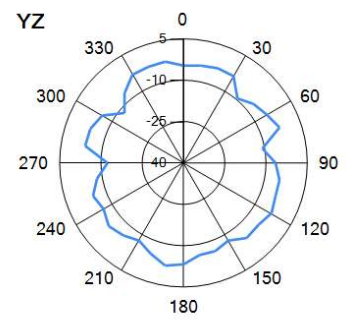
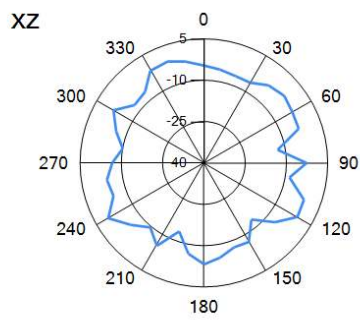
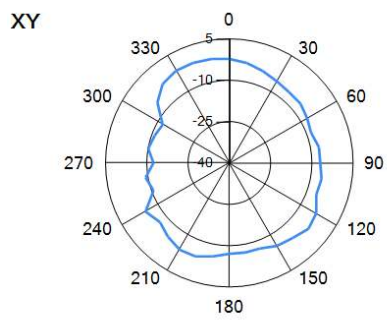
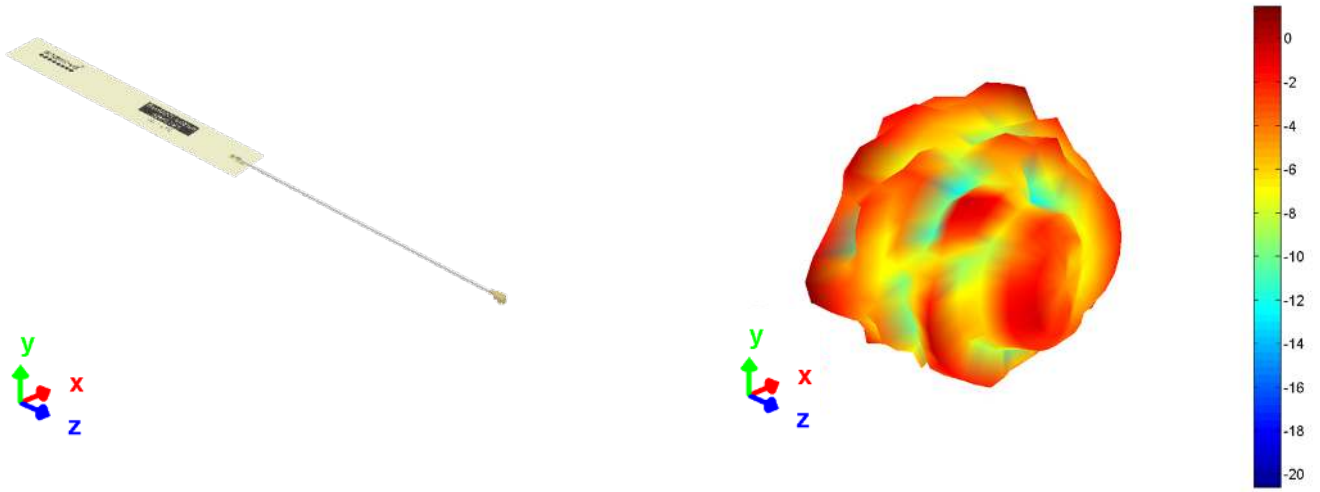

— 3.54GHz

7. Antenna dimensions

7.1. Dimensions FPC section



L	W	T
Length	Width	Thickness
95.0 ±0.2	15.0 ±0.2	0.15 (nominal)

All dimensions in (mm)

7.2. Dimensions assembled

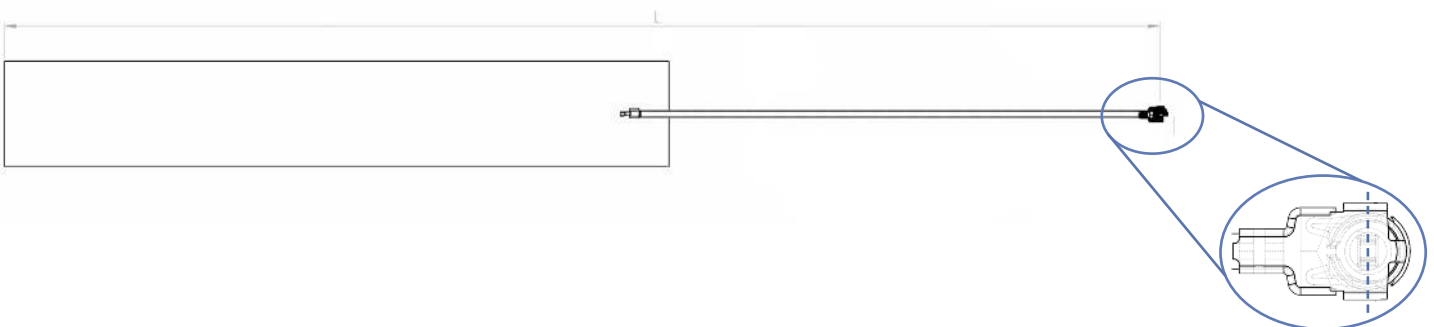

SRFL061-100	SRFL061-150
Length	Length
188 ±2.0	238 ±2.0

All dimensions in (mm)

Standard cable lengths for this antenna are 100mm and 150mm

7.3. I-PEX connector MHF1 (20278-112R-13)

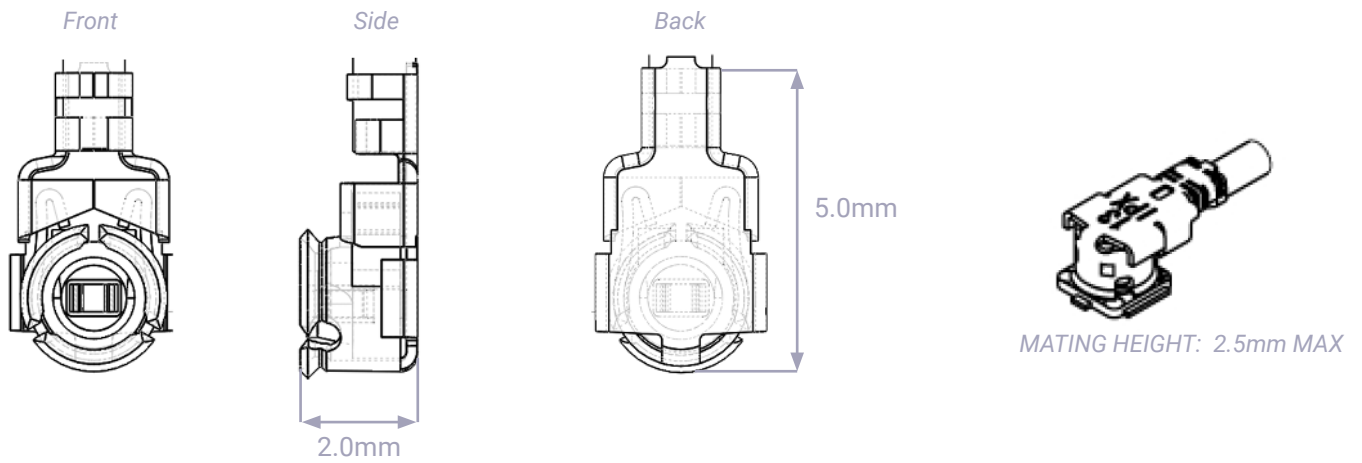

	I-PEX
MATERIAL	Copper Alloy
PLATING	Ag

All dimensions in (mm)

7.4. Assembly

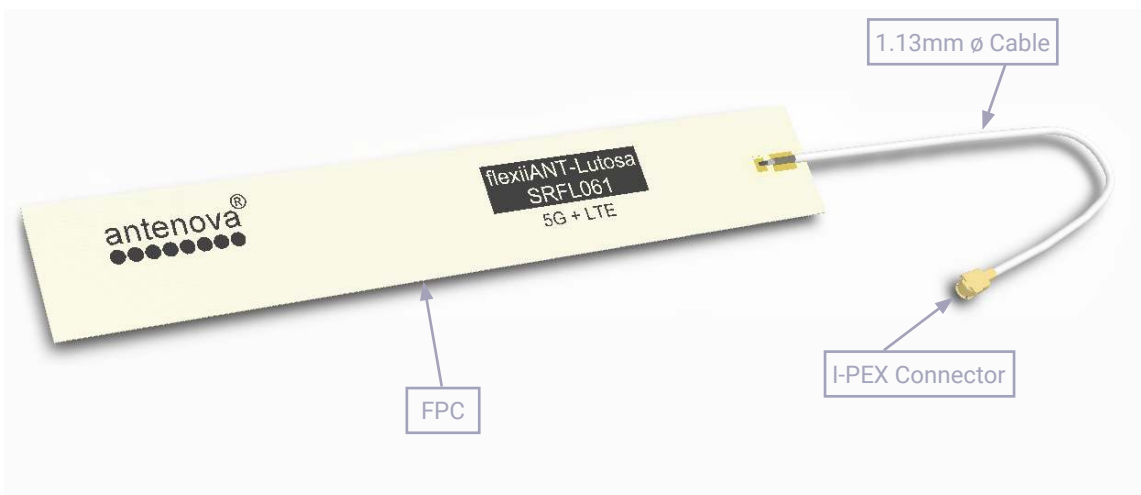

8. Electrical interface

8.1. Host interface

The host PCB requires the mating connector which is the I-PEX MHF (UFL) receptacle. The location should be close to the chip/modules pin for the RF. Any feed from this receptacle should be maintained at 50Ω impedance

8.2. Transmission line

- Must have a characteristic impedance of 50Ω.
- Length should be kept to a minimum.
- Is recommended to be a co-planar waveguide: log on to [Antenova.com](https://www.antenova.com) and try our [Transmission line calculator](#) to easily calculate the dimensions most suited to your requirements.
- Should have DC blocking capacitor (e.g. 220pF) placed in line to protect the RF front end.

9. Mechanical fixing

The antenna uses 3M 468MP adhesive on the reverse side of the FPC. The antenna has an easy access split line to peel off to reveal the adhesive side. It is designed for a one time fix to a clean smooth surface. The antenna is keyed with two 1mm locating holes for easy positioning.

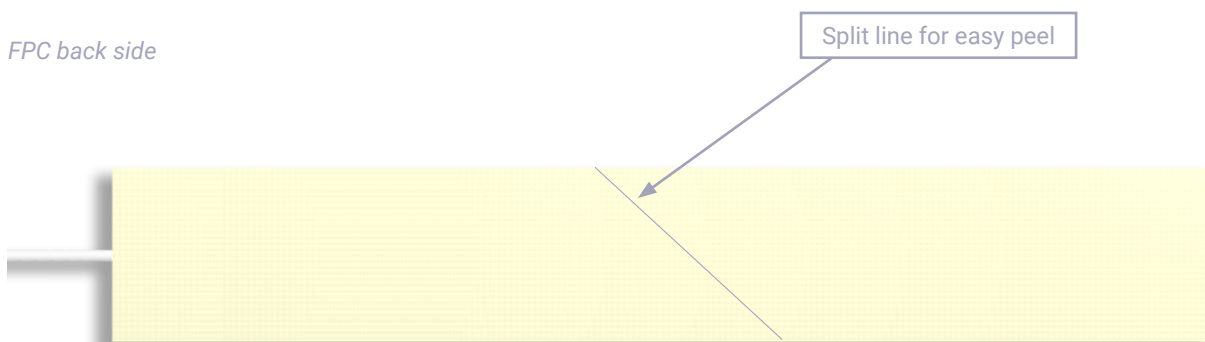

10. Antenna integration guide

We recommend the following during the design phase to maximise antenna performance and minimize noise:

- Minimum 4 layer PCB
- Route signals and power internally where possible
- Flood all layers with ground
- Knit ground on all layers together with plenty of vias

Follow placement guidance carefully, in addition Antenova provide technical support to help you through all stages of your design. Register for an account on <https://ask.antenova.com/> to access technical support.

10.1. Antenna placement

For FPC antennas the host PCB size is not critical to performance, however consideration must be given to placement. Using six spatial directions, as shown below, the antenna should ideally maintain a minimum of three directions free from obstruction in order to radiate effectively. Where there are obstructions (e.g. PCB, metal parts, battery etc.) a minimum clearance should still be maintained. These minimum clearances are described later in this section.

Six spatial directions relative to FPC

Example with 5 spatial directions clear

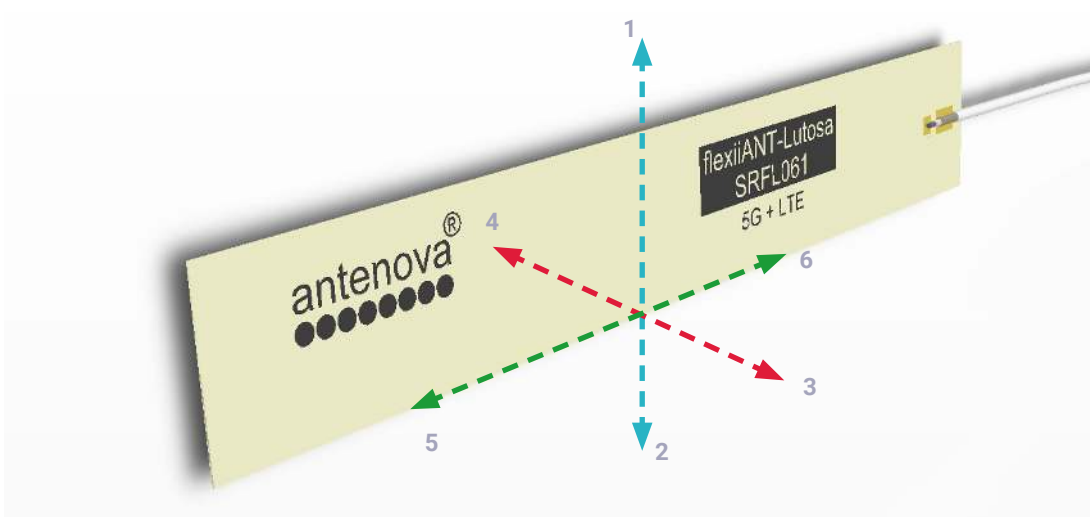

10.2. Orientation of FPC

The orientation of the FPC with respect to the host PCB should be defined depending on the unit. The proximity of the GND will have an influence on the antenna so the PCB location relative to the antenna should be considered.

The FPC will normally be placed in one of the three following options for orientation. In each option a distance (d) is the critical dimension to consider. The diagram below shows the minimum value of (d) for each. Other obstructions may increase this dimension.

Vertical mounted

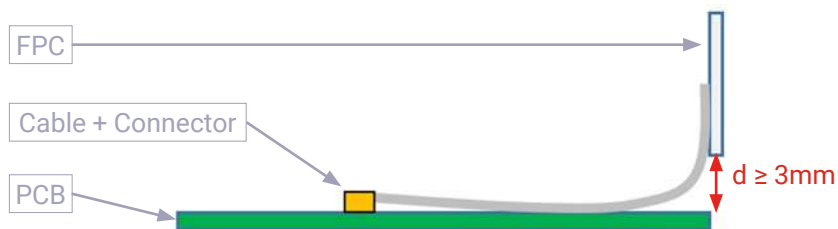

Co-planar to PCB

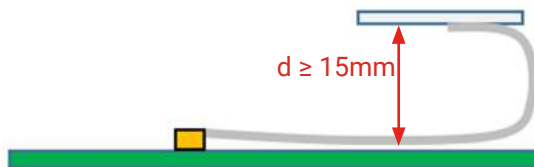

Planar to PCB (Same plane)



11. Hazardous material regulation conformance

The antenna has been tested to conform to RoHS and REACH requirements. A certificate of conformance is available from Antenova's website.

12. Packaging

The antennas are stored within an anti-static bag of 100 pcs.

100 units per bag (Labelled)



12.1. Optimal storage conditions

TEMPERATURE	-10°C to 40°C
HUMIDITY	Less than 75% RH
SHELF LIFE	18 Months
STORAGE PLACE	Away from corrosive gas and direct sunlight
PACKAGING	Antennas should be stored in unopened sealed manufacturer's plastic packaging.

Note: The shelf life of the antenna is 18 months, provided the bag of 100 pieces remains factory- sealed.

12.2. Label information



Quality statements

Antenova's products conform to REACH and RoHS legislation. For our statements regarding these and other quality standards, please see antenova.com.



Antenova reserves all rights to the contents of this document. Antenova gives no warranties based solely on the accuracy or completeness of the contents of this document and reserves the right to make changes to the specifications of the products described herein at any time and without notice.

Antenna design, integration and test resources

Product designers – the details contained in this datasheet will help you to complete your embedded antenna design. Please follow our technical advice carefully to obtain optimum antenna performance.

We aim to support our customers to create high performance wireless products. You will find a wealth of design resources, calculators and case studies to aid your design on our website.

Antenova's design laboratories are equipped with the latest antenna design tools and test chambers. We provide antenna design, test and technical integration services to help you complete your design and obtain the required certifications.

If you cannot find the antenna you require in our product range, please contact us to discuss creating a custom antenna to meet your exact requirements.

Share knowledge with RF experts around the world.

ask.antenova is a global forum for designers and engineers working with wireless technology.

[VISIT ASK.ANTENOVA](https://www.ask.antenova.com)

Visit [antenova.com](https://www.antenova.com)

Order antenna samples and evaluation boards, and read our antenna resources

[VISIT ANTENOVA.COM](https://www.antenova.com)

Request a volume quotation for antennas:

sales@antenova.com

Global headquarters

Antenova Ltd, 2nd Floor Titan Court, 3 Bishop Square, Hatfield, AL10 9NA

+44 (0) 1707 927589