

# XXA18S1PM12

Ultrasonic sensors XX, ultrasonic sensor cylindrical 90 deg M18, Sn=1 m, PNP, SYNC, connector M12



## Main

Range of Product	Telemecanique Ultrasonic sensors XX
Sensor Type	Ultrasonic sensor
Series name	General purpose
Sensor name	XXA
Sensor design	Cylindrical M18
Detection system	Diffuse with 90° head)
[Sn] nominal sensing distance	3.28 Ft (1 m) adjustable with remote teach push-button 3.28 ft (1 m) software with kit
Material	Metal
Type of output signal	Discrete
Discrete output function	1 NO or 1 NC programmable
Wiring Technique	5-wire
Discrete output type	PNP
[Us] rated supply voltage	12...24 V DC reverse polarity protection
Electrical connection	Male connector M12 5 pins
[Sd] sensing range	0.34...3.28 ft (0.105...1 m)
IP degree of protection	IP65 conforming to IEC 60529 IP67

## Complementary

Enclosure Material	Stainless steel 316L
Front material	Epoxy Rubber Resin
Supply voltage limits	10...30 V DC
Function Available	With synchronisation mode Software configurable
[Sa] assured operating distance	0.34...3.28 ft (0.105...1 m) teach mode)
Maximum differential travel	0.16 in (4 mm)
Blind zone	4.13 in (105 mm)
Transmission frequency	200 kHz
Repeat accuracy	0.1 %
Deviation angle from 90° of object to be detected	-10...10 °
Minimum size of detected object	Cylinder diameter 1 mm 23.62 in (600 mm)
Status LED	Output state 1 LED yellow) Echo state 1 LED green)
Current Consumption	30 mA
Maximum switching current	100 mA overload and short-circuit protection
Maximum voltage drop	2 V
Switching frequency	11 Hz
Setting-up	Teach mode Configurator software
Maximum delay first up	120 ms
Maximum delay response	45 ms
Maximum delay recovery	45 ms
Marking	CE

The information provided in this documentation contains general descriptions and/or technical characteristics of the performance of the products contained herein. This documentation is not intended as a substitute for and is not to be used for determining suitability or reliability of these products for specific user applications. It is the duty of any such user or integrator to perform the appropriate and complete risk analysis, evaluation and testing of the products with respect to the relevant specific application or use thereof. Neither Schneider Electric Industries SAS nor any of its affiliates or subsidiaries shall be responsible or liable for misuse of the information contained herein.

Threaded length	1.77 in (45 mm)
Height	0.71 in (18 mm)
Width	0.71 in (18 mm)
Depth	3.11 in (79 mm)
Net Weight	0.12 lb(US) (0.055 kg)

## Environment

Standards	EN/IEC 60947-5-2 CSA C22.2 No 14 UL 508
Product Certifications	RCM E2 CULus EAC Ecolab
Ambient air temperature for operation	-13...158 °F (-25...70 °C)
Ambient Air Temperature for Storage	-40...176 °F (-40...80 °C)
Vibration resistance	+/-1 mm 10...55 Hz)IEC 60068-2-6
Shock resistance	30 gn in all 3 axes 11 ms IEC 60068-2-27
Resistance to electrostatic discharge	8 kV level 4 IEC 61000-4-2
Resistance to electromagnetic fields	9.14 V/m (10 V/m) level 3 IEC 61000-4-3
Resistance to fast transients	1 kV level 3 IEC 61000-4-4

## Ordering and shipping details

Category	22489 - SENSORS XX ULTRASONIC GEN PURPOSE
Discount Schedule	DS2
GTIN	785901060369
Nbr. of units in pkg.	1
Package weight(Lbs)	1.76 oz (49.986 g)
Returnability	Yes
Country of origin	US

## Packing Units

Unit Type of Package 1	PCE
Package 1 Height	1.61 in (4.1 cm)
Package 1 width	2.52 in (6.4 cm)
Package 1 Length	3.70 in (9.4 cm)
Unit Type of Package 2	CAR
Number of Units in Package 2	1
Package 2 Weight	1.76 oz (50 g)
Package 2 Height	1.61 in (4.1 cm)
Package 2 width	2.52 in (6.4 cm)
Package 2 Length	3.70 in (9.4 cm)
Unit Type of Package 3	S01
Number of Units in Package 3	5
Package 3 Weight	20.78 oz (589 g)
Package 3 Height	5.91 in (15 cm)
Package 3 width	5.91 in (15 cm)
Package 3 Length	15.75 in (40 cm)

## Offer Sustainability

Sustainable offer status	Green Premium product
California proposition 65	WARNING: This product can expose you to chemicals including: Diisononyl phthalate (DINP), which is known to the State of California to cause cancer, and Di-isodecyl phthalate (DIDP), which is known to the State of California to cause birth defects or other reproductive harm. For more information go to <a href="http://www.P65Warnings.ca.gov">www.P65Warnings.ca.gov</a>
REACH Regulation	<a href="#">REACH Declaration</a>
EU RoHS Directive	Pro-active compliance (Product out of EU RoHS legal scope) <a href="#">EU RoHS Declaration</a>
Mercury free	Yes
RoHS exemption information	<a href="#">Yes</a>
Environmental Disclosure	<a href="#">Product Environmental Profile</a>

Dimensions

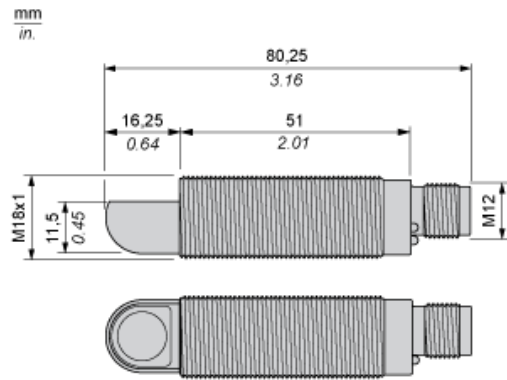

Connections

Connector Wiring

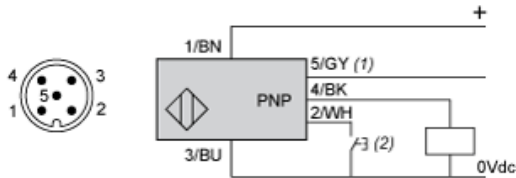

- (1) : Synchronization
- (2) : External setting pushbutton or XXZPB100 remote teach pushbutton.

Pin number	Wire color	Description
1	BN: Brown	+12...24VDC
2	WH: White	Input teach
3	BU: Blue	0 VDC
4	BK: Black	Output
5	GY: Grey	Synchronization

Wiring Scheme

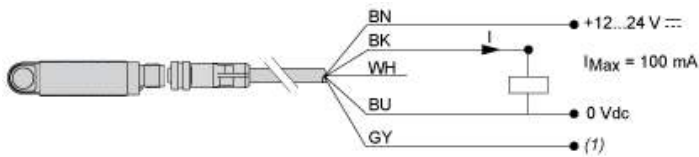

- (1) : Synchronization

Wiring for the Synchronization Function (Side by Side Application)

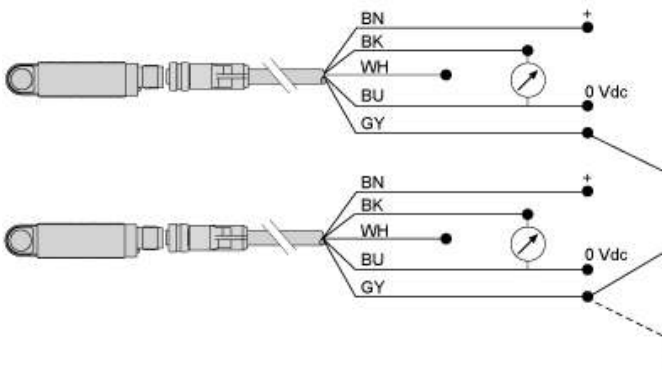

- BN : Brown
- WH : White
- BU : Blue
- BK : Black
- GY : Grey

NB: To enable synchronization between several sensors, all of the wires of pin no.5 (Grey) must be electrically connected together. A maximum of 8 sensors can be synchronized. To enable "Multiplexer" function for the sensors, use the XX Configuration Software. Without synchronization or multiplexing, the sensors must be at least 50 cm away from each other in order to avoid mutual interference.

Performance Curves

Detection Curve with 100 x 100 mm / 3.94 x 3.94 in. Square Target

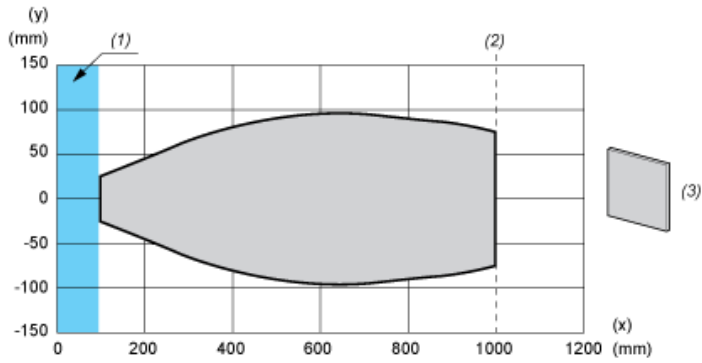

- (x) Target distance
- (y) Detection limit
- (1) : Blind zone: 105 mm
- (2) : Sn max.
- (3) : 100 x 100 mm / 3.94 x 3.94 in. stainless steel plate

Detection Curve with Round Bar

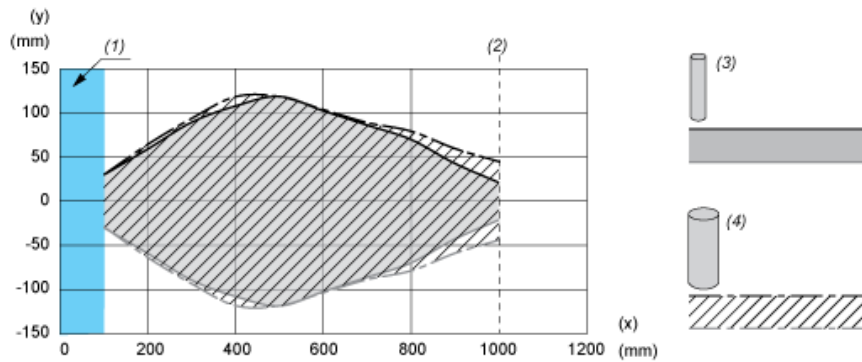

- (x) Target distance
- (y) Detection limit
- (1) : Blind zone: 105 mm
- (2) : Sn max.
- (3) : Ø 10 mm / 0.394 in. stainless steel cylinder
- (4) : Ø 25 mm / 0.984 in. stainless steel cylinder

Operating Diagrams Settings with Teach Procedure

Window Mode

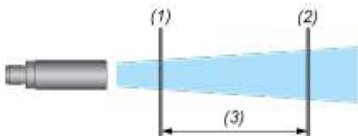

- (1) : Near limit
- (2) : Far limit
- (3) : Sensing window

Reflex Mode

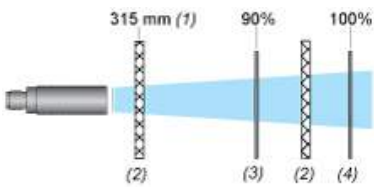

- (1) : In reflex mode, the position of the reflector must be at least 315 mm away from the sensor.
- (2) : Reflector
- (3) : Near limit
- (4) : Far limit

Proximity Mode

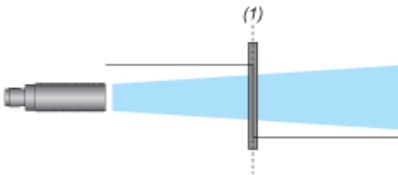

- (1) : Switch point

Pump/Hysteresis Mode

Emptying (stored in high threshold memory)

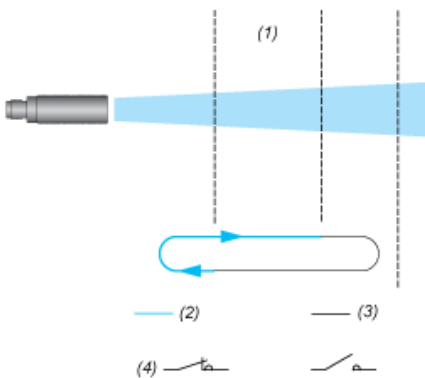

- (1) : Adjustable detection zone
- (2) : Output activated
- (3) : Output deactivated
- (4) : NO output

Filling (stored in low threshold memory)

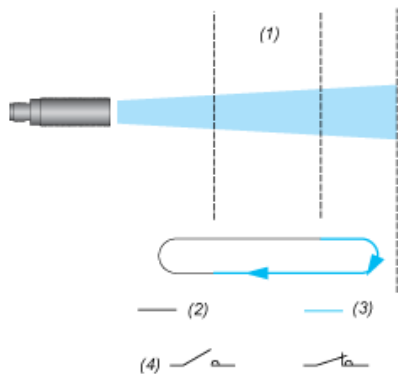

- (1) : Adjustable detection zone
- (2) : Output activated
- (3) : Output deactivated
- (4) NO output