

SF2133E-3

**1747.5 MHz
SAW Filter**

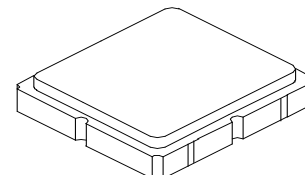

SM3030-6

- **Low Loss SAW Filter**
- **Surface Mount 3.0 x 3.0 mm Package**
- **Complies with Directive 2002/95/EC (RoHS)**
- **Moisture Sensitivity Level: 1**

Absolute Maximum Ratings

Rating	Value	Units
Input Power Level	5	dBm
DC Voltage on any Non-ground Terminal	3	V
Operable Temperature Range	-45 to +105	°C
Specification Temperature Range	-40 to +90	°C
Storage Temperature Range in Tape and Reel	-40 to +85	°C
Maximum Soldering Profile, 5 cycles/10 seconds maximum	265	°C

Electrical Characteristics

Characteristic	Sym	Notes	Min	Typ	Max +25°C	Max -20 to +70 °C	Max -40 to +90°C	Units
Center Frequency	f_C			1747.5				MHz
Insertion Loss, 1710 to 1785 MHz	IL			2.3	2.8	4.0	4.5	dB
Amplitude Ripple, 1710 to 1785 MHz				1.1		2.5	3.0	dB _{P-P}
Group Delay Ripple, 1710 to 1785 MHz	GDV			14		40		ns
Attenuation Referenced to 0 dB:								
10 to 1670 MHz			15	20				dB
1670 to 1690 MHz			6	30				
1805 to 1880 MHz			6	18				
1880 to 4500 MHz			15	21				
4500 to 5000 MHz			10	20				
Input/Output VSWR, 1710 to 1785 MHz				1.9:1		2.5:1	2.5:1	
Source Impedance	Z_S			50				Ω
Load Impedance	Z_L			50				Ω

Case Style	SM3030-6 3.0 x 3.0 mm Nominal Footprint
Lid Symbolization (Y=year, WW=week, S=shift) dot=pin 1 indicator	8R, <u>YWWS</u>

Electrical Connections

Connection	Terminals
Input	2
Output	5
Case Ground	All others

 **CAUTION: Electrostatic Sensitive Device. Observe precautions for handling.**

NOTES:

1. The design, manufacturing process, and specifications of this device are subject to change.
2. US or International patents may apply.
3. RoHS compliant from the first date of manufacture.

Frequency Characteristics

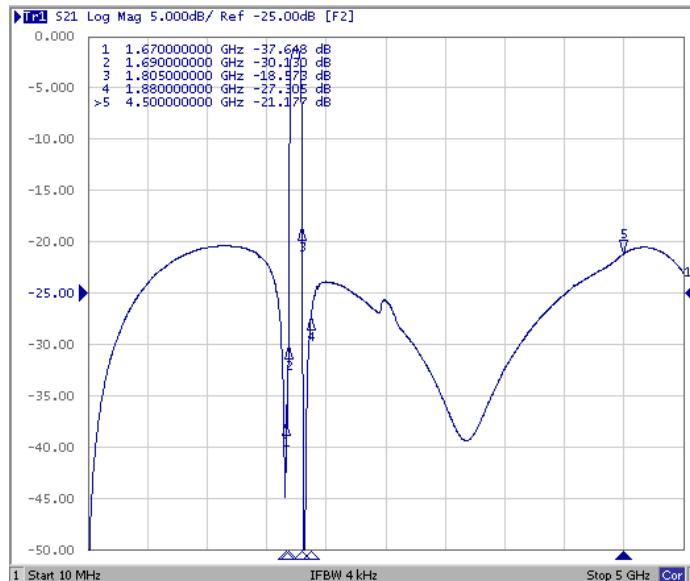
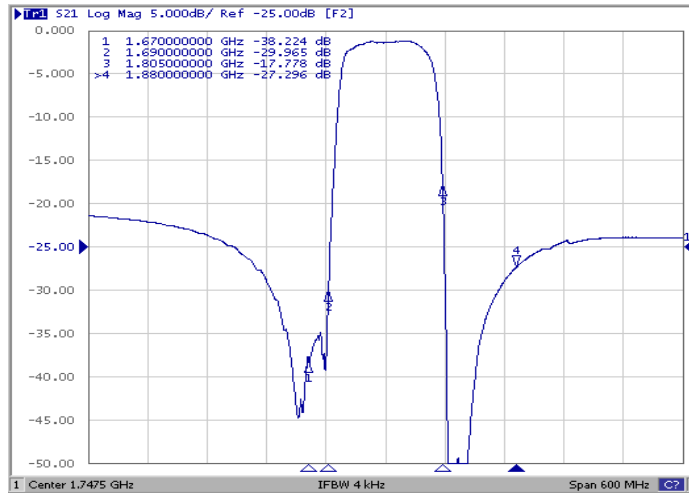
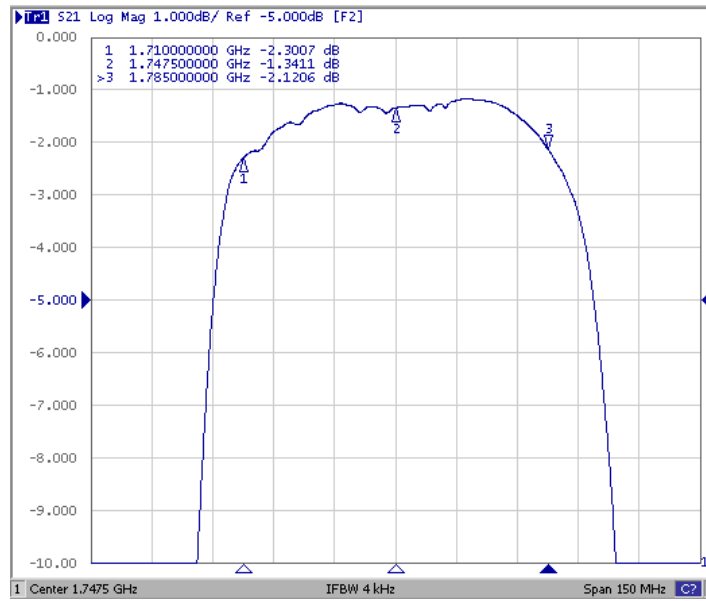

S11

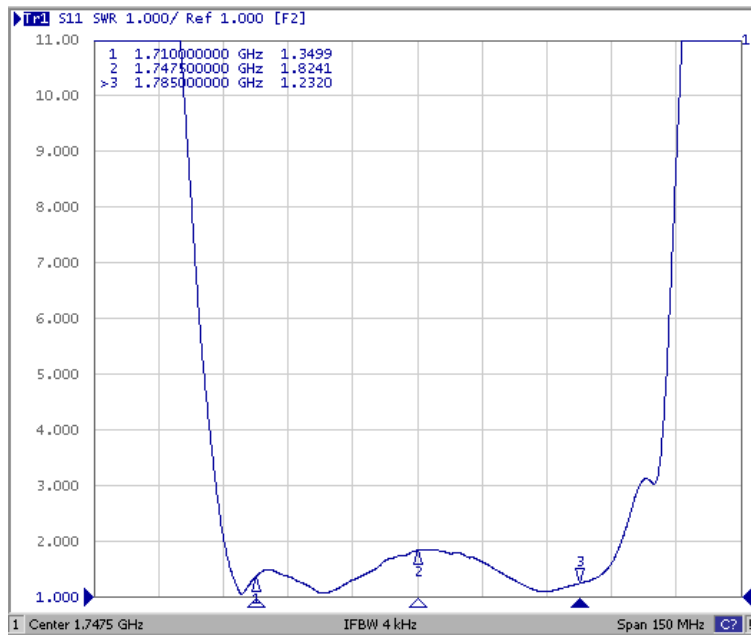

S22

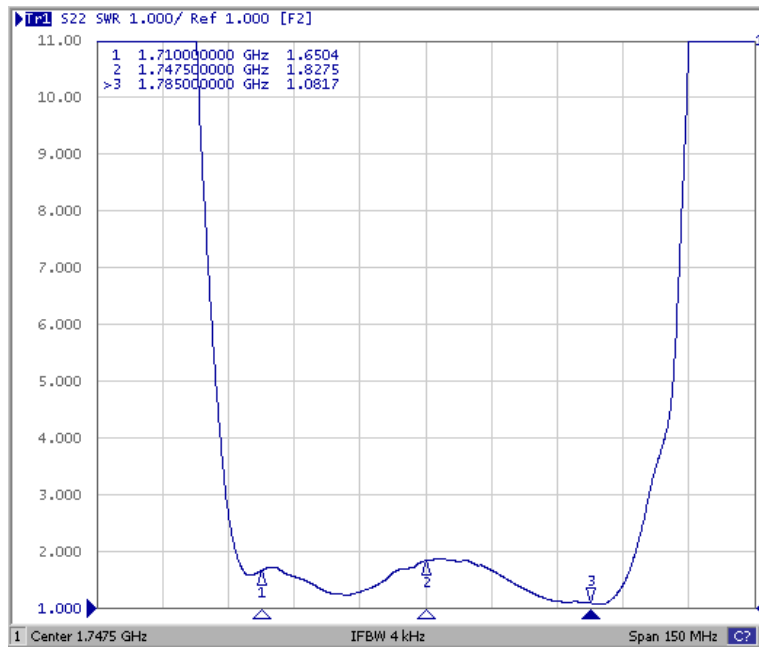

SM3030-6 Case

6-Terminal Ceramic Surface-Mount Case

3.0 X 3.0 mm Nominal Footprint

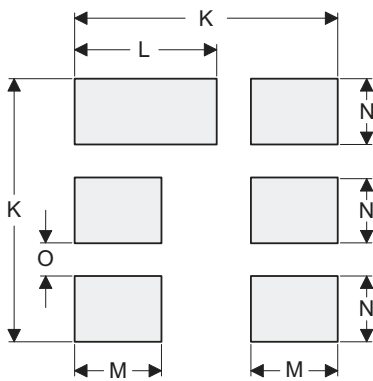
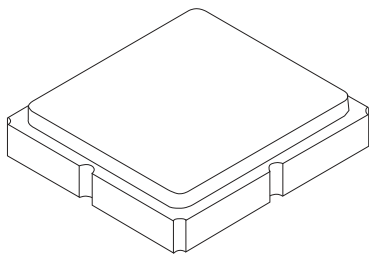

PCB Footprint Top View

Case and PCB Footprint Dimensions

Dimension	mm			Inches		
	Min	Nom	Max	Min	Nom	Max
A	2.87	3.00	3.13	0.113	0.118	0.123
B	2.87	3.00	3.13	0.113	0.118	0.123
C	1.12	1.25	1.38	0.044	0.049	0.054
D	0.77	0.90	1.03	0.030	0.035	0.040
E	2.67	2.80	2.93	0.105	0.110	0.115
F	1.47	1.60	1.73	0.058	0.063	0.068
G	0.72	0.85	0.98	0.028	0.033	0.038
H	1.37	1.50	1.63	0.054	0.059	0.064
I	0.47	0.60	0.73	0.019	0.024	0.029
J	1.17	1.30	1.43	0.046	0.051	0.056
K		3.20			0.126	
L		1.70			0.067	
M		1.05			0.041	
N		0.81			0.032	
O		0.38			0.015	

Case Materials

Materials	
Solder Pad Plating	0.3 to 1.0 μ m Gold over 1.27 to 8.89 μ m Nickel
Lid Plating	2.0 to 3.0 μ m Nickel
Body	Al ₂ O ₃ Ceramic

Top View

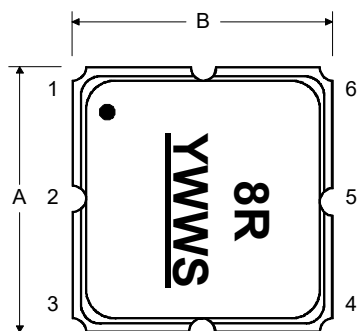

Bottom View

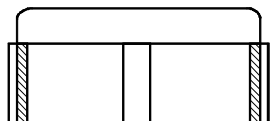
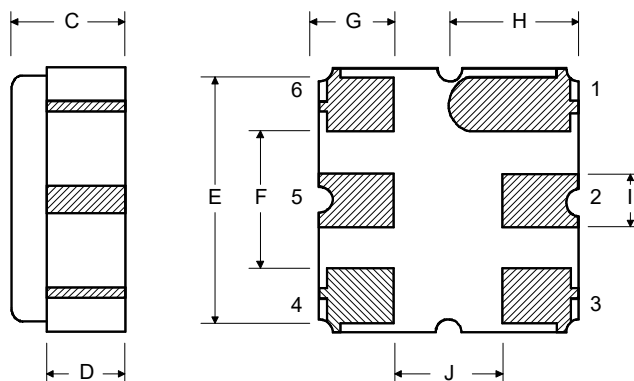

Tape and Reel Specifications

Tape and Reel Standard per ANSI/EIA-481

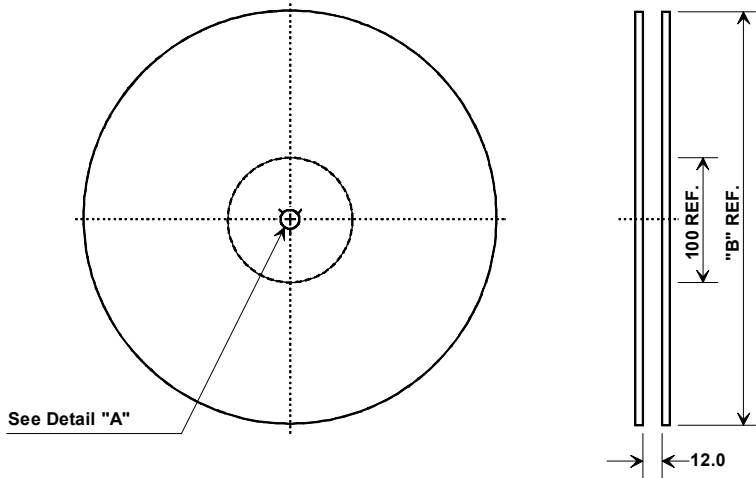

"B"		Quantity Per Reel
Inches	millimeters	
7	178	500
13	330	3000

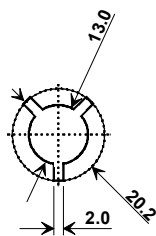

COMPONENT ORIENTATION and DIMENSIONS

Carrier Tape Dimensions	
Ao	3.35 mm
Bo	3.35 mm
Ko	1.40 mm
Pitch	4.0 mm
W	12.0 mm

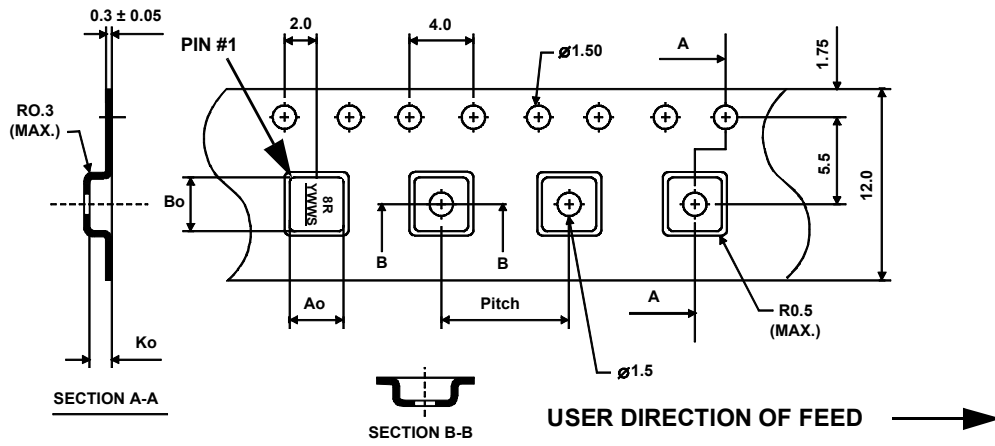

Recommended Reflow Profile

1. Preheating shall be fixed at 150~180°C for 60~90 seconds.
2. Ascending time to preheating temperature 150°C shall be 30 seconds min.
3. Heating shall be fixed at 220°C for 50~80 seconds and at 260°C+0/-5°C peak (10 seconds).
4. Time: 5 times maximum.

