

PART NUMBER	SML-LXR851SYC-TR	REV.	B
DATE	E.C.N. NUMBER AND REVISION COMMENTS		REV.
09.07.04	E.C.N. #10967.		A
05.16.11	E.C.N. #11710/10BRDR. & REDRAWN.		B

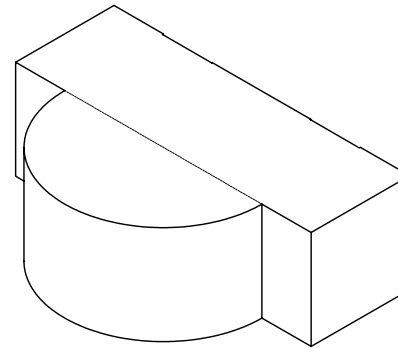

ELECTRO-OPTICAL CHARACTERISTICS TA =25°C If=20mA

PARAMETER	MIN	TYP.	MAX	UNITS	TEST COND
PEAK WAVELENGTH		590		nm	
FORWARD VOLTAGE		2.0	2.5	Vf	
REVERSE VOLTAGE	5.0			Vr	Ir=100µA
AXIAL INTENSITY		33		mcd	If=20mA
VIEWING ANGLE		160		2x theta	
EMITTED COLOR:	YELLOW				
EPOXY LENS FINISH:	WATER CLEAR				

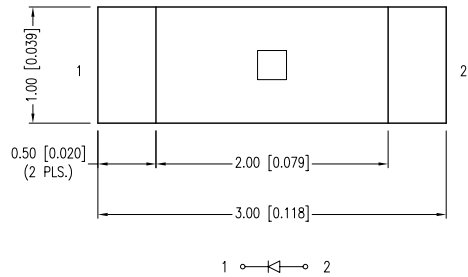
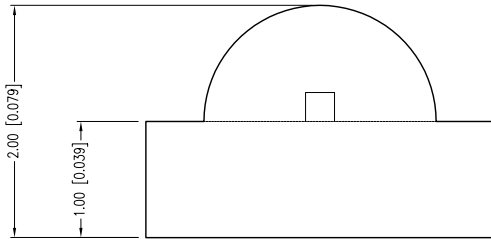

A LIMITS OF SAFE OPERATION AT 25°C

PARAMETER	MAX	UNITS
PEAK FORWARD CURRENT*	160	mA
STEADY CURRENT	30	mA
POWER DISSIPATION	100	mW
DERATE FROM 25°C	-1.2	mW/°C
OPERATING TEMP.	-25 TO +85	°C
STORAGE TEMP.	-30 TO +90	°C

* t<10µs

B CAUTION: MOISTURE SENSITIVE DEVICE
PER JEDEC LEVEL 2 STANDARDS

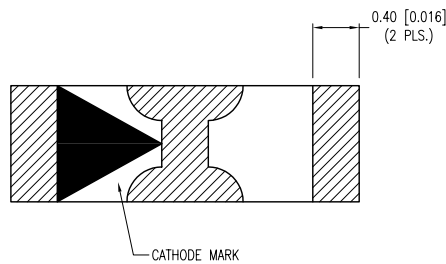

RECOMMENDED SOLDER PAD LAYOUT

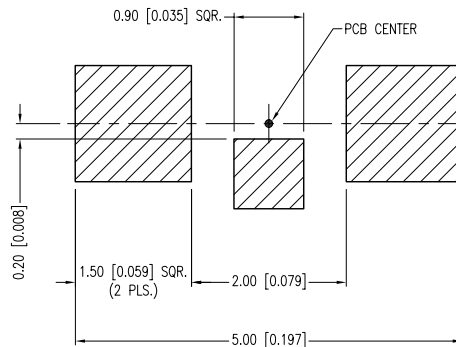

*UNLESS OTHERWISE SPECIFIED TOLERANCES PER DECIMAL PRECISION ARE: X=±1 (±0.039), X.X=±0.5 (±0.020), X.XX=±0.25 (±0.010), X.XXX=±0.127 (±0.005). LEAD SIZE=±0.05 (±0.002), LEAD LENGTH=±0.75 (±0.030). MIN.= +DECIMAL PRECISION MAX.= +0.00 -DECIMAL PRECISION UNCONTROLLED DOCUMENT

LUMEX
Creating LED and LCD Solutions Together™

290 E. HELEN ROAD
PALATINE, IL 60067-6976
PHONE: +1.847.359.2790
FAX: +1.847.359.6538
WEB: WWW.LUMEX.COM

1.0x3.0mm PCB RIGHT ANGLE SURFACE MOUNT LED, 590nm SUPER YELLOW, WATER CLEAR, TAPE & REEL.

THE SPECIFICATIONS MAY CHANGE AT ANY TIME WITHOUT NOTICE DUE TO NEW MATERIALS OR PRODUCT IMPROVEMENT.

CONFIDENTIAL INFORMATION
THE INFORMATION CONTAINED IN THIS DOCUMENT IS THE PROPERTY OF LUMEX INC. EXCEPT AS SPECIFICALLY AUTHORIZED IN WRITING BY LUMEX INC., THE HOLDER OF THIS DOCUMENT SHALL KEEP ALL INFORMATION CONTAINED HEREIN CONFIDENTIAL AND SHALL PROTECT SAME IN WHOLE OR IN PART FROM DISCLOSURE AND DISSEMINATION TO ALL THIRD PARTIES.

DATE:	05.16.11	DRAWN BY:	AB
PAGE:	1 OF 2	CHKD BY:	KF
SCALE:	NTS	APRVD BY:	SS
UNIT:	mm [INCH]		Ⓟ

PART NUMBER	SML-LXR851SYC-TR	REV.	B
DATE	E.C.N. NUMBER AND REVISION COMMENTS		REV.
09.07.04	E.C.N. #10967.		A
05.16.11	E.C.N. #11710/10BRDR. & REDRAWN.		B

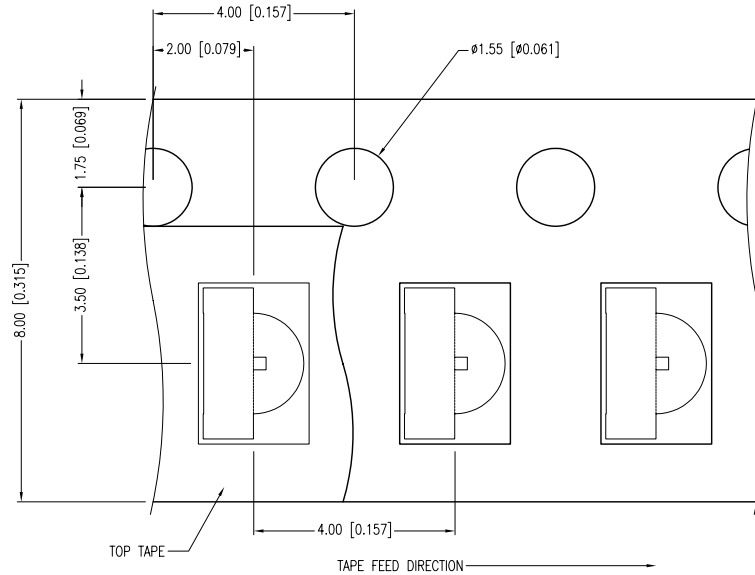
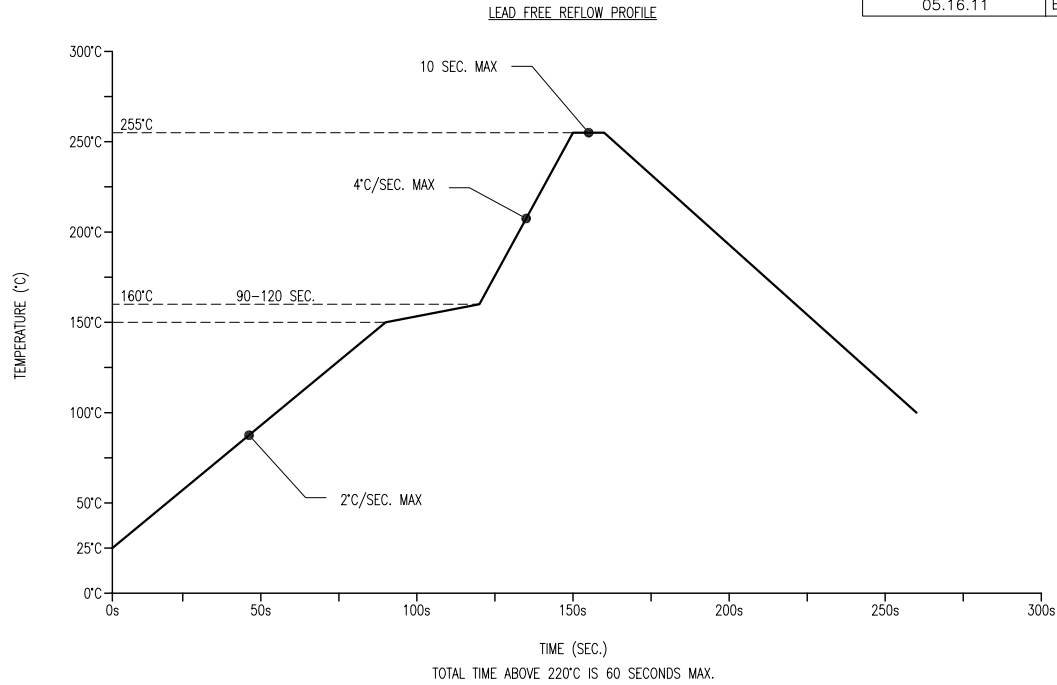

- NOTES:**
- 2,000 PER REEL.
 - THE CATHODE IS ORIENTED TOWARDS THE TAPE SPROCKET HOLE.

*UNLESS OTHERWISE SPECIFIED TOLERANCES PER DECIMAL PRECISION ARE: X=±1 (±0.039), X.X=±0.5 (±0.020), X.XX=±0.25 (±0.010), X.XXX=±0.127 (±0.005). LEAD SIZE=±0.05 (±0.002), LEAD LENGTH=±0.75 (±0.030). MIN= ^{+DECIMAL PRECISION} -0.00 _{-DECIMAL PRECISION}



290 E. HELEN ROAD
PALATINE, IL 60067-6976
PHONE: +1.847.359.2790
FAX: +1.847.359.6538
WEB: WWW.LUMEX.COM

1.0x3.0mm PCB RIGHT ANGLE SURFACE MOUNT LED, 590nm SUPER YELLOW, WATER CLEAR, TAPE & REEL.

THE SPECIFICATIONS MAY CHANGE AT ANY TIME WITHOUT NOTICE DUE TO NEW MATERIALS OR PRODUCT IMPROVEMENT.

CONFIDENTIAL INFORMATION
THE INFORMATION CONTAINED IN THIS DOCUMENT IS THE PROPERTY OF LUMEX INC. EXCEPT AS SPECIFICALLY AUTHORIZED IN WRITING BY LUMEX INC., THE HOLDER OF THIS DOCUMENT SHALL KEEP ALL INFORMATION CONTAINED HEREIN CONFIDENTIAL AND SHALL PROTECT SAME IN WHOLE OR IN PART FROM DISCLOSURE AND DISSEMINATION TO ALL THIRD PARTIES.

DATE:	05.16.11	DRAWN BY:	AB
PAGE:	2 OF 2	CHKD BY:	KF
SCALE:	NTS	APRVD BY:	SS
UNIT:	mm [INCH]		Ⓟ