



MICROCHIP

**MTCH112 Evaluation Kit
User's Guide**

Note the following details of the code protection feature on Microchip devices:

- Microchip products meet the specification contained in their particular Microchip Data Sheet.
- Microchip believes that its family of products is one of the most secure families of its kind on the market today, when used in the intended manner and under normal conditions.
- There are dishonest and possibly illegal methods used to breach the code protection feature. All of these methods, to our knowledge, require using the Microchip products in a manner outside the operating specifications contained in Microchip's Data Sheets. Most likely, the person doing so is engaged in theft of intellectual property.
- Microchip is willing to work with the customer who is concerned about the integrity of their code.
- Neither Microchip nor any other semiconductor manufacturer can guarantee the security of their code. Code protection does not mean that we are guaranteeing the product as "unbreakable."

Code protection is constantly evolving. We at Microchip are committed to continuously improving the code protection features of our products. Attempts to break Microchip's code protection feature may be a violation of the Digital Millennium Copyright Act. If such acts allow unauthorized access to your software or other copyrighted work, you may have a right to sue for relief under that Act.

Information contained in this publication regarding device applications and the like is provided only for your convenience and may be superseded by updates. It is your responsibility to ensure that your application meets with your specifications. MICROCHIP MAKES NO REPRESENTATIONS OR WARRANTIES OF ANY KIND WHETHER EXPRESS OR IMPLIED, WRITTEN OR ORAL, STATUTORY OR OTHERWISE, RELATED TO THE INFORMATION, INCLUDING BUT NOT LIMITED TO ITS CONDITION, QUALITY, PERFORMANCE, MERCHANTABILITY OR FITNESS FOR PURPOSE. Microchip disclaims all liability arising from this information and its use. Use of Microchip devices in life support and/or safety applications is entirely at the buyer's risk, and the buyer agrees to defend, indemnify and hold harmless Microchip from any and all damages, claims, suits, or expenses resulting from such use. No licenses are conveyed, implicitly or otherwise, under any Microchip intellectual property rights.

Trademarks

The Microchip name and logo, the Microchip logo, dsPIC, FlashFlex, flexPWR, JukeBlox, KEELOQ, KEELOQ logo, Kleer, LANCheck, MediaLB, MOST, MOST logo, MPLAB, OptoLyzer, PIC, PICSTART, PIC³² logo, RightTouch, SpyNIC, SST, SST Logo, SuperFlash and UNI/O are registered trademarks of Microchip Technology Incorporated in the U.S.A. and other countries.

The Embedded Control Solutions Company and mTouch are registered trademarks of Microchip Technology Incorporated in the U.S.A.

Analog-for-the-Digital Age, BodyCom, chipKIT, chipKIT logo, CodeGuard, dsPICDEM, dsPICDEM.net, ECAN, In-Circuit Serial Programming, ICSP, Inter-Chip Connectivity, KleerNet, KleerNet logo, MiWi, MPASM, MPF, MPLAB Certified logo, MPLIB, MPLINK, MultiTRAK, NetDetach, Omniscient Code Generation, PICDEM, PICDEM.net, PICkit, PICtail, RightTouch logo, REAL ICE, SQI, Serial Quad I/O, Total Endurance, TSHARC, USBCheck, VariSense, ViewSpan, WiperLock, Wireless DNA, and ZENA are trademarks of Microchip Technology Incorporated in the U.S.A. and other countries.

SQTP is a service mark of Microchip Technology Incorporated in the U.S.A.

Silicon Storage Technology is a registered trademark of Microchip Technology Inc. in other countries.

GestIC is a registered trademarks of Microchip Technology Germany II GmbH & Co. KG, a subsidiary of Microchip Technology Inc., in other countries.

All other trademarks mentioned herein are property of their respective companies.

© 2014-2015, Microchip Technology Incorporated, Printed in the U.S.A., All Rights Reserved.

ISBN: 978-1-63277-006-6

QUALITY MANAGEMENT SYSTEM
CERTIFIED BY DNV
== ISO/TS 16949 ==

Microchip received ISO/TS-16949:2009 certification for its worldwide headquarters, design and wafer fabrication facilities in Chandler and Tempe, Arizona; Gresham, Oregon and design centers in California and India. The Company's quality system processes and procedures are for its PIC[®] MCUs and dsPIC[®] DSCs, KEELOQ[®] code hopping devices, Serial EEPROMs, microperipherals, nonvolatile memory and analog products. In addition, Microchip's quality system for the design and manufacture of development systems is ISO 9001:2000 certified.

Table of Contents

Preface 5

Chapter 1. MTCH112 Overview

 1.1 Introduction 11

 1.1.1 Kit Contents 11

 1.2 Hardware Setup 11

 1.2.1 MTCH112 Controller Board 11

 1.2.2 MTCH112 Sensor Boards 12

 1.3 MTCH112 GUI 13

 1.3.1 Sensor Control and Configuration (Area A) 15

 1.3.2 Input Sensing Output Pin Configuration (Area B) 15

 1.3.3 Input Sensing System Configuration (Area C) 16

 1.3.3.1 Sleep Time 16

 1.3.3.2 System Clock 16

 1.3.3.3 Press Threshold 16

 1.3.3.4 Proximity Threshold 16

 1.3.3.5 Button-Press Time-Out 16

 1.3.3.6 I²C™ Address 17

 1.3.4 Real-Time Sensor Status (Area D) 17

 1.3.5 Real-Time Sensor Information (Area E) 17

 1.3.6 The Plot (Area F) 18

 1.3.7 Product Reset (Area G) 18

 1.3.8 Application Configuration and Data Log (Area H) 19

 1.3.8.1 Reading an mTouch™ Configuration 19

 1.3.8.2 Saving the current mTouch Configuration 19

 1.3.8.3 Logging the Real-Time Data 19

 1.3.8.4 Adjusting the Plot Area 20

 1.3.9 The Plot Control Area 21

 1.3.9.1 Auto-Scroll Checkbox 21

 1.3.9.2 Play Button 21

 1.3.9.3 Playback Speed Slider 21

 1.3.9.4 Stop Button 21

 1.3.9.5 Position Slider 22

 1.3.9.6 Print 22

Appendix A. MTCH112 Controller Board Schematic

Appendix B. MTCH112 Controller Board Layout

Appendix C. MTCH112 Proximity Sensor Board Layout

Appendix D. MTCH112 Dual Touch Sensor Board Layout

Worldwide Sales and Service 31

MTCH112 Evaluation Kit User's Guide

NOTES:

Preface

NOTICE TO CUSTOMERS

All documentation becomes dated, and this manual is no exception. Microchip tools and documentation are constantly evolving to meet customer needs, so some actual dialogs and/or tool descriptions may differ from those in this document. Please refer to our web site (www.microchip.com) to obtain the latest documentation available.

Documents are identified with a “DS” number. This number is located on the bottom of each page, in front of the page number. The numbering convention for the DS number is “DSXXXXA”, where “XXXX” is the document number and “A” is the revision level of the document.

For the most up-to-date information on development tools, see the MPLAB® IDE online help. Select the Help menu, and then Topics to open a list of available online help files.

INTRODUCTION

This chapter contains general information that will be useful to know before using the MTCH112 Evaluation Kit. Items discussed in this chapter include:

- Document Layout
- Conventions Used in this Guide
- Recommended Reading
- The Microchip Web Site
- Development Systems Customer Change Notification Service
- Customer Support
- Revision History

DOCUMENT LAYOUT

This document describes how to use the MTCH112 Evaluation Kit to quickly get started with Microchip's Touch Input Sensing technology. The document is organized as follows:

- **Chapter 1. “MTCH112 Overview”**
- **Appendix A. “MTCH112 Controller Board Schematic ”**
- **Appendix B. “MTCH112 Controller Board Layout ”**
- **Appendix C. “MTCH112 Proximity Sensor Board Layout ”**
- **Appendix D. “MTCH112 Dual Touch Sensor Board Layout ”**

MTCH112 Evaluation Kit User's Guide

CONVENTIONS USED IN THIS GUIDE

This manual uses the following documentation conventions:

DOCUMENTATION CONVENTIONS

Description	Represents	Examples
Arial font:		
Italic characters	Referenced books	<i>MPLAB[®] IDE User's Guide</i>
	Emphasized text	...is the <i>only</i> compiler...
Initial caps	A window	the Output window
	A dialog	the Settings dialog
	A menu selection	select Enable Programmer
Quotes	A field name in a window or dialog	"Save project before build"
Underlined, italic text with right angle bracket	A menu path	<u><i>File>Save</i></u>
Bold characters	A dialog button	Click OK
	A tab	Click the Power tab
N'Rnnnn	A number in verilog format, where N is the total number of digits, R is the radix and n is a digit.	4'b0010, 2'hF1
Text in angle brackets < >	A key on the keyboard	Press <Enter>, <F1>
Courier New font:		
Plain Courier New	Sample source code	#define START
	Filenames	autoexec.bat
	File paths	c:\mcc18\h
	Keywords	_asm, _endasm, static
	Command-line options	-Opa+, -Opa-
	Bit values	0, 1
	Constants	0xFF, 'A'
Italic Courier New	A variable argument	<i>file.o</i> , where <i>file</i> can be any valid filename
Square brackets []	Optional arguments	mcc18 [options] <i>file</i> [options]
Curly brackets and pipe character: { }	Choice of mutually exclusive arguments; an OR selection	errorlevel {0 1}
Ellipses...	Replaces repeated text	var_name [, var_name...]
	Represents code supplied by user	void main (void) { ... }

RECOMMENDED READING

This user's guide describes how to use Microchip's MTCH112 Evaluation Kit. Other useful documents are listed below. The following Microchip documents are available and recommended as supplemental reference resources.

<http://www.microchip.com>

MTCH112 Dual-Channel Proximity/Touch Controller Data Sheet (DS41668)

This data sheet provides detailed information regarding the MTCH112.

MTCH112 Dual-Channel Proximity Touch Controller Product Brief (DS41659)

This product brief provides marketing information regarding the MTCH112.

MTCH112 Evaluation Kit User's Guide

THE MICROCHIP WEB SITE

Microchip provides online support via our web site at www.microchip.com. This web site is used as a means to make files and information easily available to customers. Accessible by using your favorite Internet browser, the web site contains the following information:

- **Product Support** – Data sheets and errata, application notes and sample programs, design resources, user's guides and hardware support documents, latest software releases and archived software
- **General Technical Support** – Frequently Asked Questions (FAQs), technical support requests, online discussion groups, Microchip consultant program member listing
- **Business of Microchip** – Product selector and ordering guides, latest Microchip press releases, listing of seminars and events, listings of Microchip sales offices, distributors and factory representatives

DEVELOPMENT SYSTEMS CUSTOMER CHANGE NOTIFICATION SERVICE

Microchip's customer notification service helps keep customers current on Microchip products. Subscribers will receive e-mail notification whenever there are changes, updates, revisions or errata related to a specified product family or development tool of interest.

To register, access the Microchip web site at www.microchip.com, click on Customer Change Notification and follow the registration instructions.

The Development Systems product group categories are:

- **Compilers** – The latest information on Microchip C compilers, assemblers, linkers and other language tools. These include all MPLAB C compilers; all MPLAB assemblers (including MPASM™ assembler); all MPLAB linkers (including MPLINK™ object linker); and all MPLAB librarians (including MPLIB™ object librarian).
- **Emulators** – The latest information on Microchip in-circuit emulators. This includes the MPLAB REAL ICE™ and MPLAB ICE 2000 in-circuit emulators.
- **In-Circuit Debuggers** – The latest information on the Microchip in-circuit debuggers. This includes MPLAB ICD 3 in-circuit debuggers and PICKit™ 3 debug express.
- **MPLAB® IDE** – The latest information on Microchip MPLAB IDE, the Windows® Integrated Development Environment for development systems tools. This list is focused on the MPLAB IDE, MPLAB IDE Project Manager, MPLAB Editor and MPLAB SIM simulator, as well as general editing and debugging features.
- **Programmers** – The latest information on Microchip programmers. These include production programmers such as MPLAB REAL ICE in-circuit emulator, MPLAB ICD 3 in-circuit debugger and MPLAB PM3 device programmers. Also included are nonproduction development programmers such as PICSTART® Plus and PICKit 2 and 3.

CUSTOMER SUPPORT

Users of Microchip products can receive assistance through several channels:

- Distributor or Representative
- Local Sales Office
- Field Application Engineer (FAE)
- Technical Support

Customers should contact their distributor, representative or field application engineer (FAE) for support. Local sales offices are also available to help customers. A listing of sales offices and locations is included in the back of this document.

Technical support is available through the web site at:

<http://www.microchip.com/support>.

REVISION HISTORY

Revision A (October 2014)

Initial release of this document.

Revision B (January 2015)

Updated Figure A-1; Other minor corrections.

MTCH112 Evaluation Kit User's Guide

NOTES:

Chapter 1. MTCH112 Overview

1.1 INTRODUCTION

The MTCH112 Evaluation Kit allows the user to implement up to two Touch and/or Proximity input channels very quickly with many options to tune the MTCH112 device to meet user application requirements. The user can alter multiple internal parameters that affect the chip's sensitivity, response time, power consumption, and behavior.

1.1.1 Kit Contents

- MTCH112 Controller Board
- MTCH112 Touch-Button Sensor Board
- MTCH112 Proximity Sensor Board
- Mini to USB-B Cable

1.2 HARDWARE SETUP

Before using the board, it is necessary to connect some of the hardware elements included in the kit. Described below are the hardware items required to correctly operate the board.

1.2.1 MTCH112 Controller Board

FIGURE 1-1: MTCH112 MOTHERBOARD

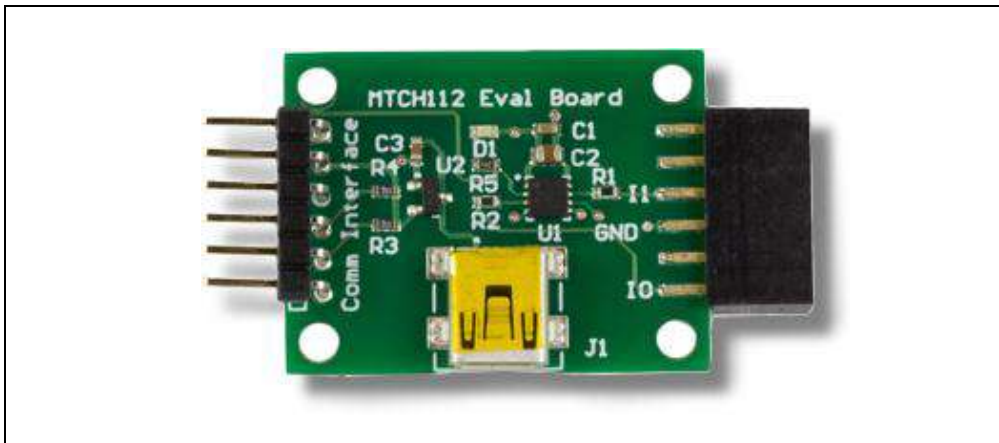
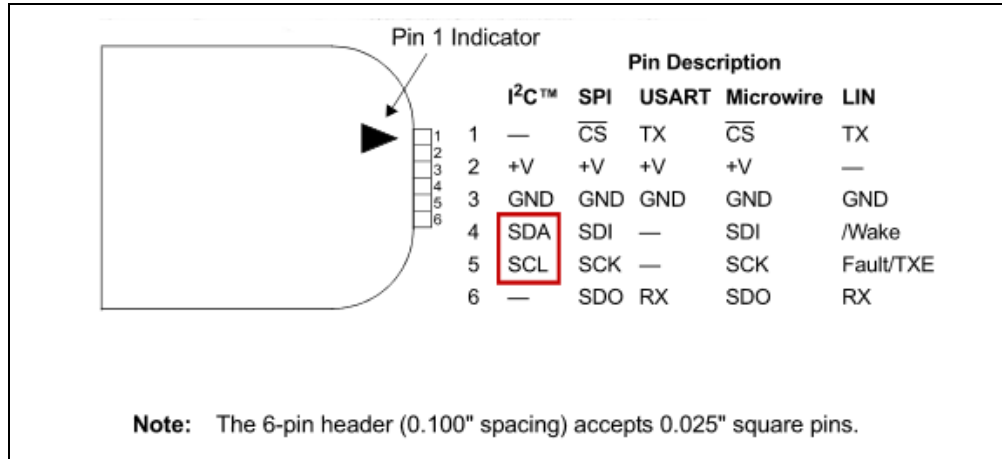

Figure 1-1 shows the main board with the MTCH112 chip (U1 Chip on board). It handles every aspect of the touch input process. It expects a capacitive touch sensor on the female 12-pin header connector to the right of the U1 chip. Either of the sensor boards included in the package can be connected to the controller board. Alternatively, the user can connect up to two sensors to the pins labeled I0 and I1 on the PCB.

MTCH112 Evaluation Kit User's Guide

To the left of the U1 chip, the board has a 6-pin header connector labeled 'Comm Interface', mainly used to allow the input sensing application to communicate with a host system. The connector's pins are assigned to accommodate PICKit™ Serial Analyzer communications (Figure 1-2). This feature allows the board not only to report its sensor state information in real time, but to be controlled and configured by a host device at any time. The MTCH112 and the evaluation board use I²C™ protocol involving only two signals (SCL and SDA, as highlighted below). For a full set of I²C commands and related timings, please refer to the MTCH112 data sheet (DS41668) at www.microchip.com/mtch112.

FIGURE 1-2: PICKit™ SERIAL ANALYZER CONNECTOR PIN MAPPING



The MTCH112 Evaluation Board can be powered by applying 3.3V to pin 2 of the communication connector, or by connecting an already powered USB cable.

Once it is powered, the board is operational. This can be easily checked by connecting one of the sensor boards and directly touching a sensor. A touch should light the red LED (D1) on the controller board.

1.2.2 MTCH112 Sensor Boards

The Evaluation Kit comes with one Touch (with two sensors) daughter board (below left) and one proximity sensor daughter board (below right) as shown in Figure 1-3.

FIGURE 1-3: MTCH112 KIT SENSOR BOARDS

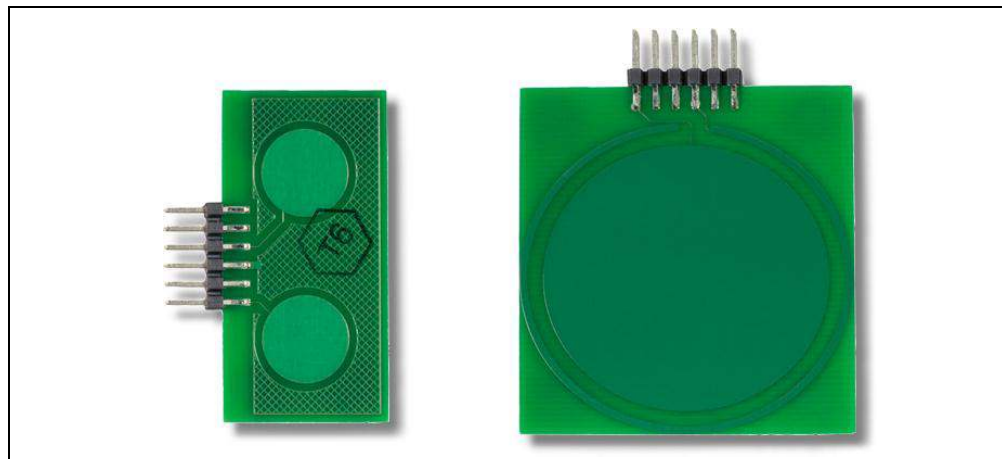

The Proximity sensor board has a built-in guard ring that can be driven by the MTCH112 controller to maximize the sensitivity.

FIGURE 1-4: PICKit™ SERIAL ANALYZER



The optional PICKit Serial Communication interface (Figure 1-4) is not part of the evaluation kit. It is sold separately and available on microchipDIRECT (DV164122). This communication interface device becomes necessary when the MTCH112 Windows® GUI is used. The PICKit Serial Analyzer allows bridging I²C (and more) to USB, a popular communication hardware to personal computers in general and PC/Windows in particular.

The PICKit Serial Analyzer should be connected on one end to the 6-pin header connector of the MTCH112 controller board, and the other end to a USB port of a Windows computer.

With all these items connected, the board should be fully operational and ready to communicate with the Windows-based MTCH112 GUI.

1.3 MTCH112 GUI

After installing and running Microchip's MTCH112 GUI, the user is presented with power setting options (Figure 1-5) if the controller board is not yet powered through the USB connector.

FIGURE 1-5: MTCH112 EVALUATION KIT GUI POWER OPTION

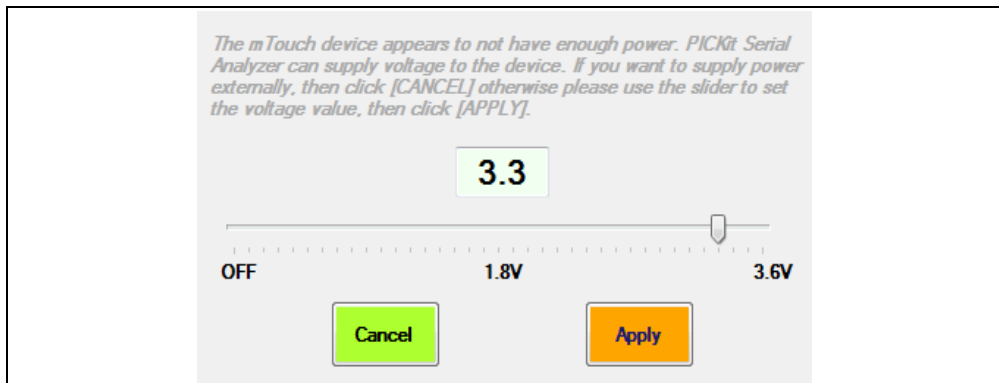

MTCH112 Evaluation Kit User's Guide

Move the slider so that it selects 3.3V and click **Apply**. This will start the GUI and the application's main window will appear as shown below (see [Figure 1-6](#)).

FIGURE 1-6: MTCH112 GUI MAIN WINDOW

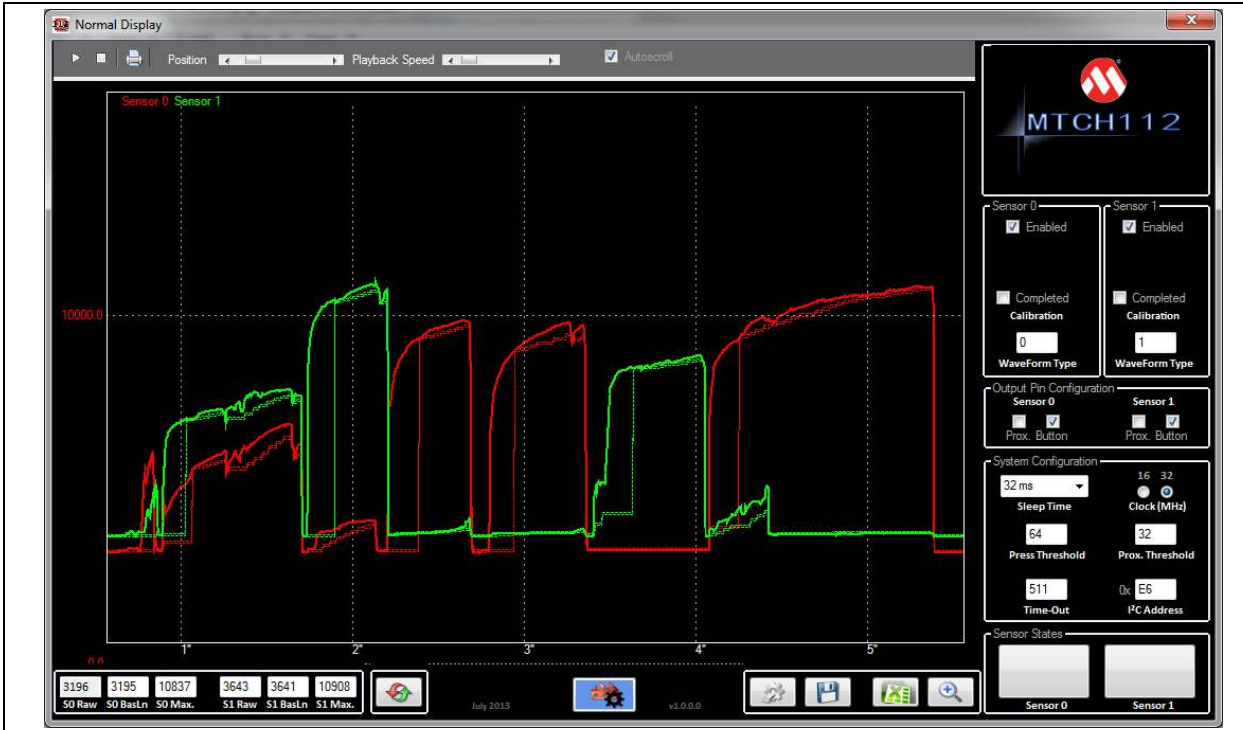

The GUI window can be divided into nine functional areas identified A through I, as shown below in [Figure 1-7](#).

FIGURE 1-7: MTCH112 GUI FUNCTIONAL AREAS

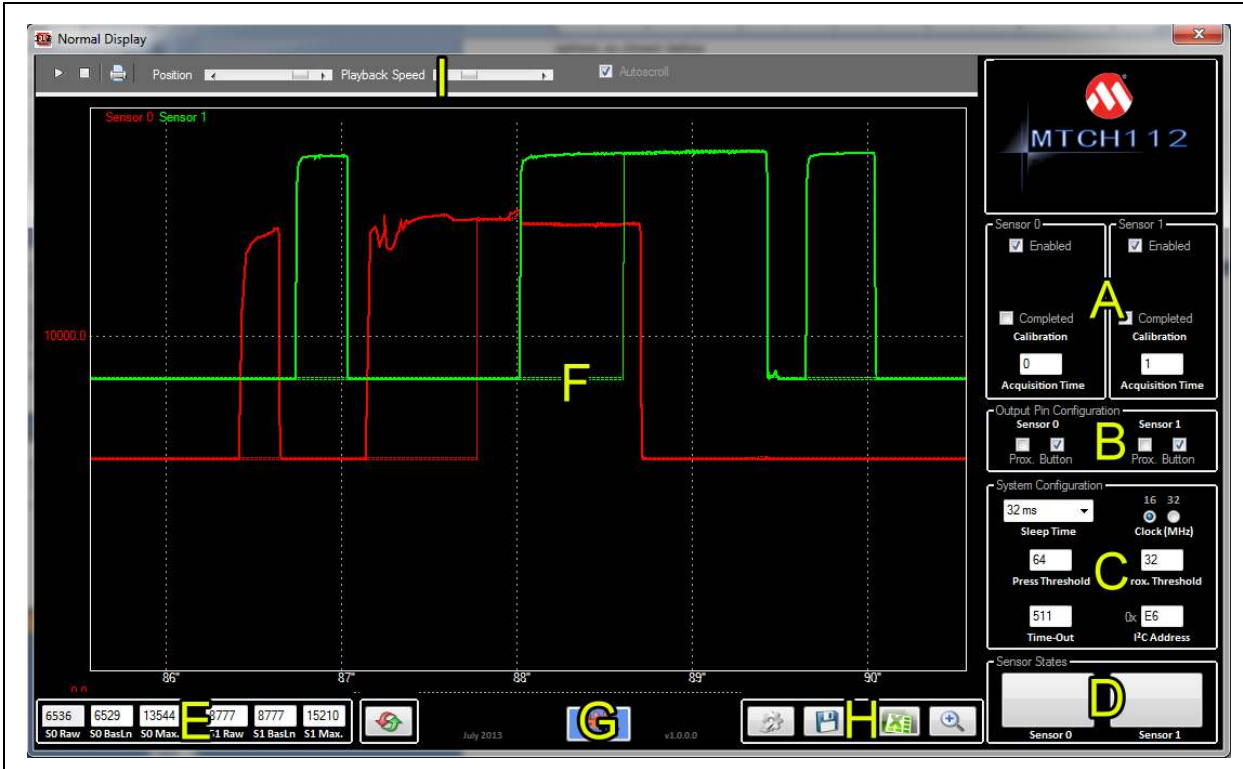

- A: Sensor Control and Configuration
- B: Input Sensing Output Pin Configuration
- C: Input Sensing System Configuration
- D: Real-Time Sensor Status
- E: Real-Time Sensor Information
- F: Plot Area
- G: Product Reset Area
- H: GUI Miscellaneous (storage and configuration)
- I: Plot Control

1.3.1 Sensor Control and Configuration (Area A)

FIGURE 1-8: SENSOR CONTROL AND CONFIGURATION AREA (A)

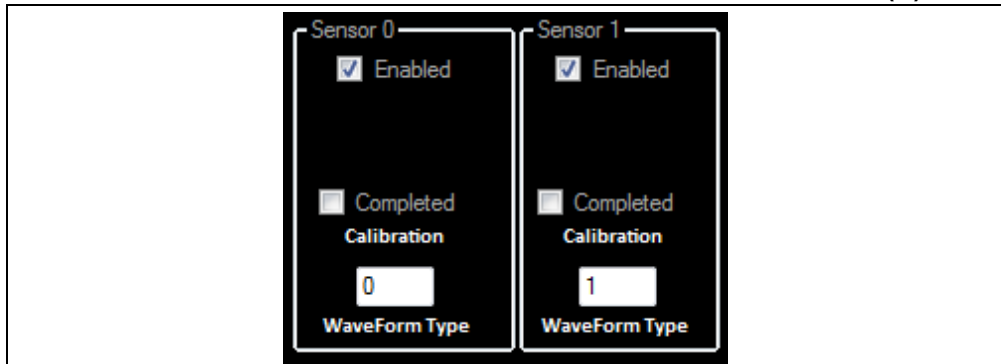

This area specifies whether the MTCH112 controller is managing a single sensor (default sensor 0) or two by enabling or disabling sensor 1, respectively.

A calibration of each sensor can be started using the Calibration checkbox. The system shows **'Completed'** once the calibration of the controller is complete.

The MTCH112 controller automatically selects the acquisition waveform type during the calibration process and notifies the GUI.

1.3.2 Input Sensing Output Pin Configuration (Area B)

FIGURE 1-9: INPUT SENSING OUTPUT PIN CONFIGURATION (B)

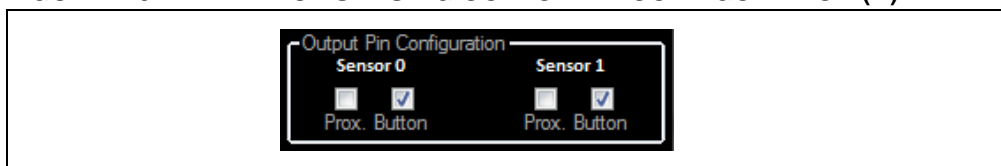

The MTCH112 controller uses a single interrupt output pin to notify the host about the detection of a new event on one or more of its sensors. This area allows the user to specify which events the MTCH112 controller generates notification about.

Once the host system gets the new event detection notification, an I²C command should be issued to read the button state mask, which provides what event type and which sensor generated the event.

MTCH112 Evaluation Kit User's Guide

1.3.3 Input Sensing System Configuration (Area C)

FIGURE 1-10: INPUT SENSING SYSTEM CONFIGURATION AREA (C)

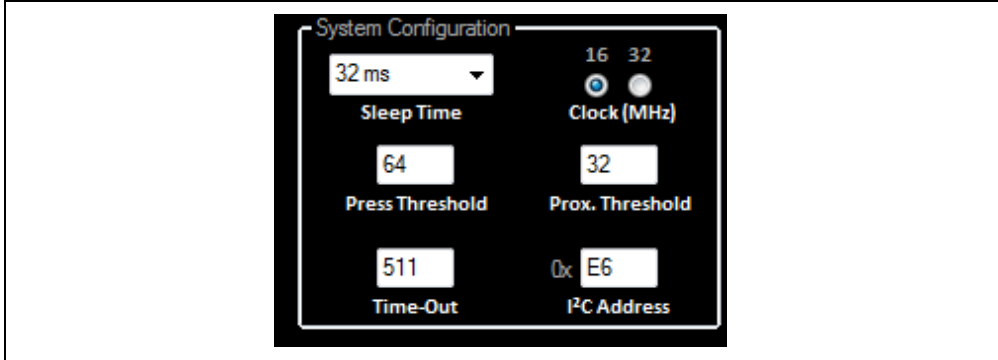

This area allows the user to interact with the system parameters which affect the way Touch Input Sensing behaves. Following is a list of parameters controlled by this area.

1.3.3.1 SLEEP TIME

This control specifies the time between two scans. This directly affects the application power consumption and response time. The user can choose a value from 1 millisecond to 256 seconds Sleep Time.

1.3.3.2 SYSTEM CLOCK

The user can set the controller's main clock to either 16 MHz or 32 MHz, depending on whether the application primarily requires performance (32 MHz) or lower power consumption (16 MHz).

1.3.3.3 PRESS THRESHOLD

When a sensor is used as a button, the user can specify the minimum value for the readings beyond which the MTCH112 controller considers that the button is in the **Pressed** state. One way to determine a good value for the threshold is to perform a few touches and check the maximum value of the shift (Area E). The threshold can be set to a percentage of the maximum shift.

Another parameter that should be considered when setting the threshold value is the noise level. The threshold value should be set above the highest level of noise to avoid false button triggers due to noise.

1.3.3.4 PROXIMITY THRESHOLD

Same as above, but for Proximity detection.

1.3.3.5 BUTTON-PRESS TIME-OUT

When a button is detected as pressed, the system uses a time-out mechanism before forcing this button to a **Released** state, in case the button is pressed for too long. This feature helps prevent stuck buttons. Setting 0 instructs the application to never time out.

1.3.3.6 I²C™ ADDRESS

The MTCH112 controller uses I²C protocol (and bus) to communicate with a host controller. In the case where multiple MTCH112 controllers are used in the same system, or the MTCH112 is used on an I²C bus where its slave address is already assigned to another device, the user has the ability to assign a new I²C address to the MTCH112 to avoid any conflict. This is done by specifying a new hexadecimal value in this control box.

1.3.4 Real-Time Sensor Status (Area D)

FIGURE 1-11: REAL-TIME SENSOR STATUS AREA (D)

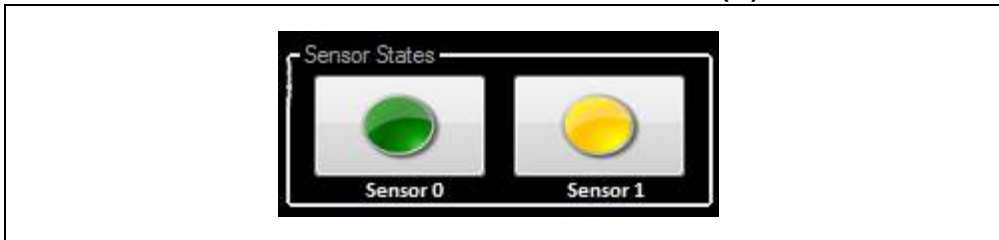

This area depicts the actual state of the active sensors managed by the MTCH112 controller, using colored buttons.

The absence of any button indicates its Released state.

A Green button shows an actual Press.

A Yellow button shows a Proximity detection event.

Any other type of button shown would mean a problem with the sensor (e.g., shorted) or an unrecognized state.

1.3.5 Real-Time Sensor Information (Area E)

FIGURE 1-12: REAL-TIME SENSOR INFORMATION AREA (E)

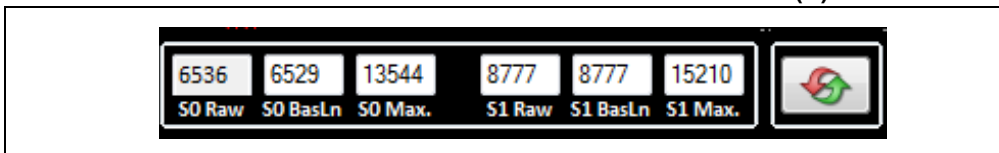

For each active sensor, this area displays the latest raw value, current baseline value (which reflects the environment), and keeps track of the highest raw value observed since the start of the application or the maximum values were reset.

The last control button on the far right side of this area resets the maximum raw values recorded to date. The system will then start tracking the next maximum value it sees.

MTCH112 Evaluation Kit User's Guide

1.3.6 The Plot (Area F)

This section of the GUI is responsible for acquiring the real-time data sent by the MTCH112 controller, and representing it as a continuous plot allowing the user to easily track any change on the sensors' signals. The red line represents Sensor0's signal and the green line represents Sensor1's signal.

The dotted graph lines (with the same color convention) track each sensor's baseline over time.

FIGURE 1-13: GUI PLOT AREA (F)

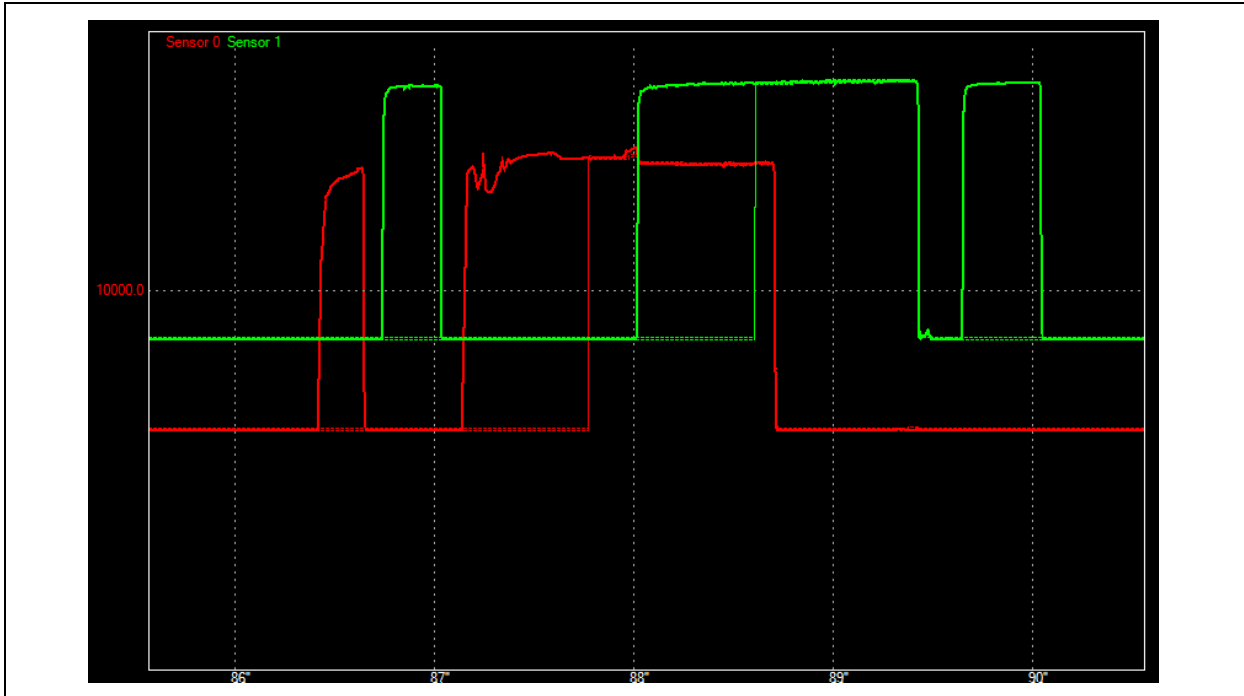

1.3.7 Product Reset (Area G)

FIGURE 1-14: PRODUCT RESET AREA (G)



Touch systems can get very complex based on the number of parameters they involve in order to get them to operate at their optimum performance. Each parameter can have significant impact on the system's performance.

The GUI allows the user to reset the system to its factory configuration by clicking the control button shown above.

1.3.8 Application Configuration and Data Log (Area H)

FIGURE 1-15: APPLICATION AND DATA LOG AREA (H)



This area provides four buttons for control of miscellaneous functions for the GUI and the Input Sensing application. The button functions will be considered from left to right.

1.3.8.1 READING AN mTouch™ CONFIGURATION

FIGURE 1-16: RECALLING A PREVIOUSLY SAVED CONFIGURATION



The user has the ability to save all parameters at any time and recall from the computer's Hard Disk Drive (HDD) and set them into the MTCH112 controller.

1.3.8.2 SAVING THE CURRENT mTouch CONFIGURATION

FIGURE 1-17: SAVING CURRENT mTouch™ CONFIGURATION



This button saves all current parameter values to the computer's hard drive.

1.3.8.3 LOGGING THE REAL-TIME DATA

FIGURE 1-18: LOGGING REAL-TIME DATA



In some cases, in order to track the Input System's performance, a significant amount of information is required. The GUI offers to save all sensor data in an Excel File format (CSV) for easy data analysis.

The button shown above, when pressed, will open the following window, expecting the user to make a few choices before starting the data recording.

MTCH112 Evaluation Kit User's Guide

FIGURE 1-19: REAL-TIME LOG CONFIGURATION



The user can specify a CSV file name and location, required to start the recording process using the checkbox at the top of the window.

When the user presses the **Done** button, the window closes and the recording starts and runs in the background.

The user can then at any time press this button again and simply deselect the checkbox at the top (which should read '**Running**') to stop the recording process and access the Excel file for analysis.

1.3.8.4 ADJUSTING THE PLOT AREA

FIGURE 1-20: ZOOMING INTO AND OUT OF THE PLOT AREA



Zooming in and out of the graph representation of the data can be performed using the button shown above. When clicked, the GUI grants the user with the following window where the zooming range can be set.

FIGURE 1-21: ZOOM SETTINGS

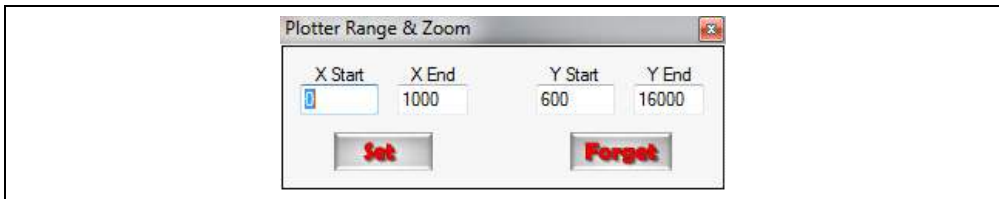

The X-values basically specify how many Raw Data samples are graphed in the visible area. The values above show that the GUI is displaying the values of 1000 samples at any time. It also shows that it is displaying samples from 0 to 1000.

The Y-values simply specify which range of data will be taken into account for display. The values shown above instruct the plot window to only display Raw Readings between 600 and 16000 counts.

The user can finally either activate these values by pressing '**Set**' or ignore them and keep whichever values the GUI was previously using by pressing '**Forget**'.

1.3.9 The Plot Control Area

At the top of the plot area a grey toolbar allows control of how the plotter behaves. Below is a description of the different buttons.

FIGURE 1-22:



1.3.9.1 AUTO-SCROLL CHECKBOX

In reality, two different types of controls allow interaction with the scrolling: The **Autoscroll** checkbox and the **Play** button.

FIGURE 1-23: THE AUTO-SCROLL CHECKBOX

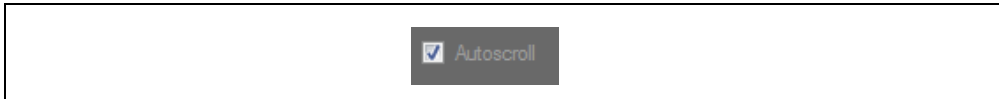

The Auto-scroll checkbox, which activates and de-activates the automatic calculation of the scrolling speed (which depends on the rate at which the data gets to the GUI), allows the plot window to keep up with the latest data to be plotted at the right side of the plot area.

When Auto-scroll is unchecked, the plot window will keep scrolling, at the speed set by the '**Playback Speed**' slider.

1.3.9.2 PLAY BUTTON

FIGURE 1-24: THE PLAY BUTTON



This button enables the scrolling of the display. It reads the speed value set by the '**Playback Speed**' slider and starts the scrolling through the data from the current position and to the right of the display.

1.3.9.3 PLAYBACK SPEED SLIDER

FIGURE 1-25: THE PLAYBACK SPEED SLIDER

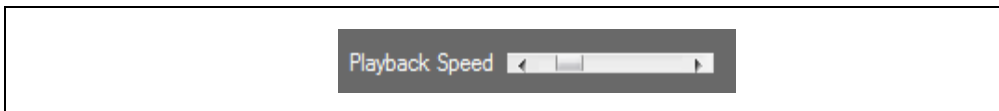

This slider controls the speed at which the graphed data is browsed. The **Play** button will use the value set by this control to scroll through the received data.

1.3.9.4 STOP BUTTON

FIGURE 1-26: THE STOP BUTTON



When pressed and Auto-scroll is disabled, this button stops the scrolling.

MTCH112 Evaluation Kit User's Guide

1.3.9.5 POSITION SLIDER

FIGURE 1-27: THE BROWSING POSITION SLIDER



This slider allows the user to rapidly browse through the received data. The plot window keeps track of all the readings received since the application was started. The graphs can be recalled or checked by stopping the scrolling and browsing with either the Position slider or using the mouse pointer by clicking and holding while scrolling.

1.3.9.6 PRINT

FIGURE 1-28: PRINTING THE GRAPHS

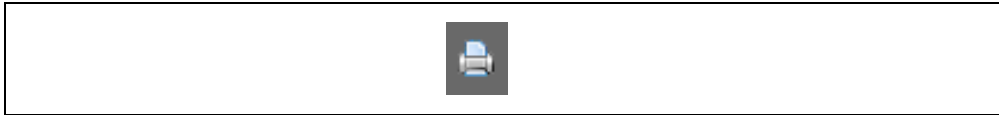

This button sends the visible part of the graphs to a Windows® printer.



Appendix A. MTCH112 Controller Board Schematic

FIGURE A-1: MTCH112 CONTROLLER BOARD SCHEMATIC

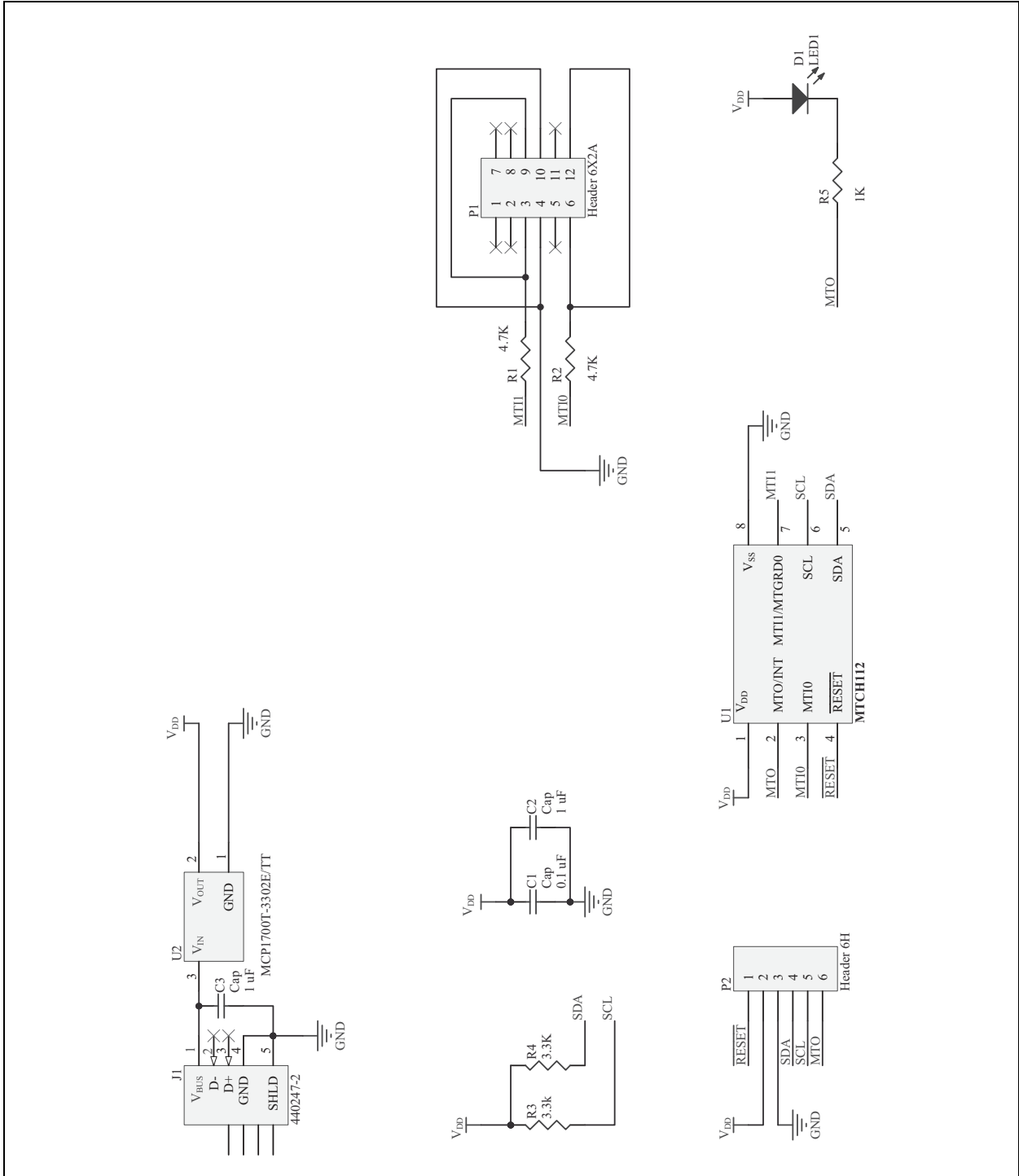

MTCH112 Evaluation Kit User's Guide

NOTES:

Appendix B. MTCH112 Controller Board Layout

FIGURE B-1: MTCH112 CONTROLLER BOARD LAYOUT

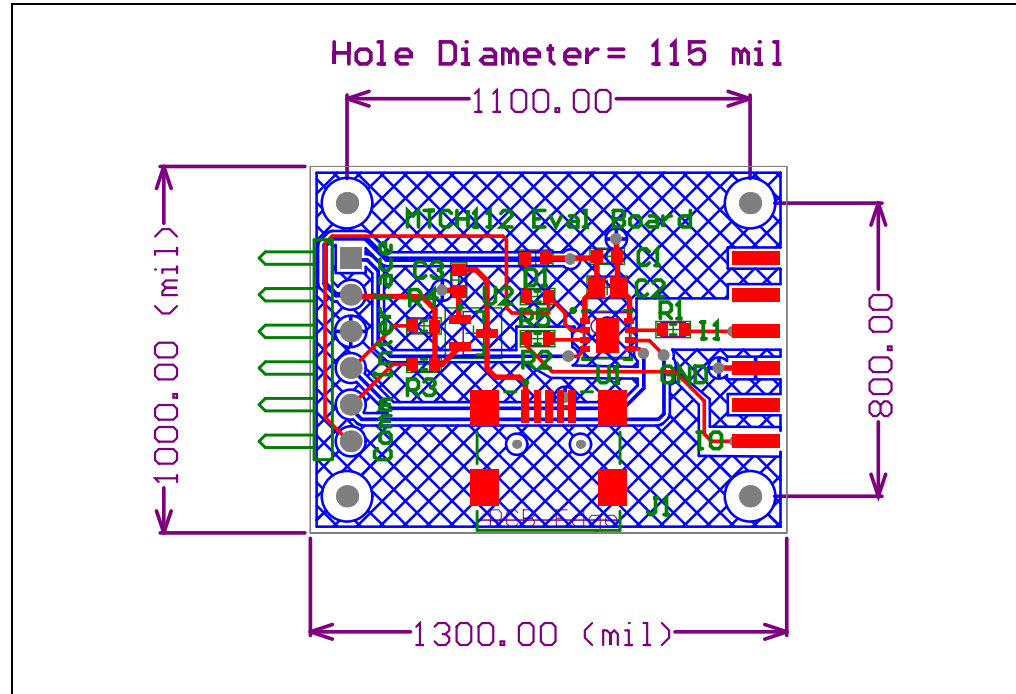

MTCH112 Evaluation Kit User's Guide

NOTES:



Appendix C. MTCH112 Proximity Sensor Board Layout

FIGURE C-1: MTCH112 PROXIMITY SENSOR BOARD LAYOUT

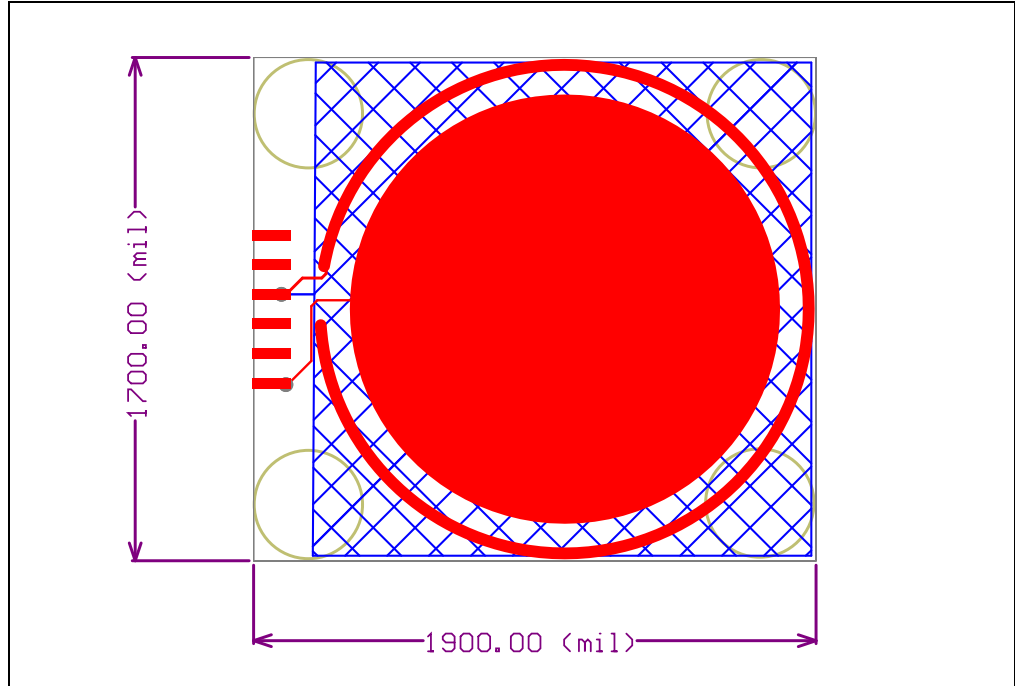

MTCH112 Evaluation Kit User's Guide

NOTES:



Appendix D. MTCH112 Dual Touch Sensor Board Layout

FIGURE D-1: MTCH112 DUAL TOUCH SENSOR BOARD LAYOUT

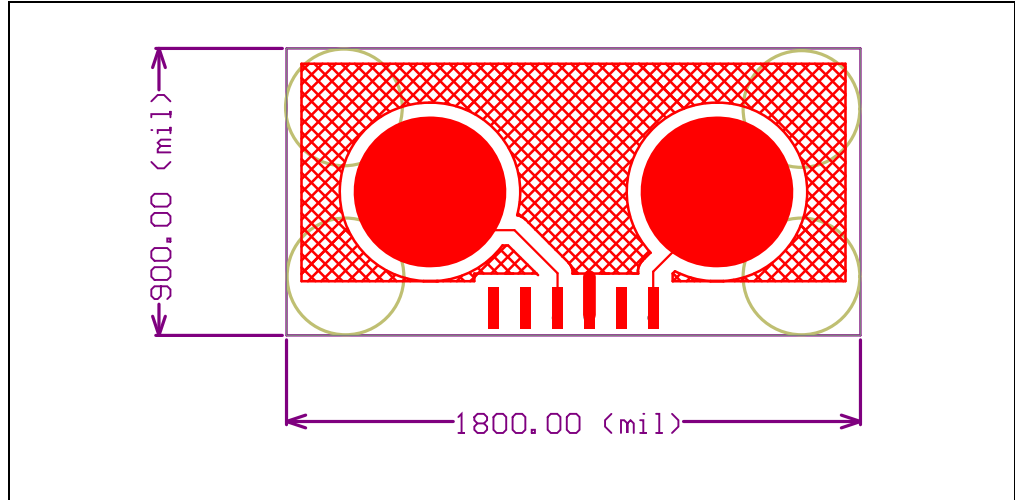

MTCH112 Evaluation Kit User's Guide

NOTES:



MICROCHIP

Worldwide Sales and Service

AMERICAS

Corporate Office
2355 West Chandler Blvd.
Chandler, AZ 85224-6199
Tel: 480-792-7200
Fax: 480-792-7277
Technical Support:
<http://www.microchip.com/support>
Web Address:
www.microchip.com

Atlanta
Duluth, GA
Tel: 678-957-9614
Fax: 678-957-1455

Austin, TX
Tel: 512-257-3370

Boston
Westborough, MA
Tel: 774-760-0087
Fax: 774-760-0088

Chicago
Itasca, IL
Tel: 630-285-0071
Fax: 630-285-0075

Cleveland
Independence, OH
Tel: 216-447-0464
Fax: 216-447-0643

Dallas
Addison, TX
Tel: 972-818-7423
Fax: 972-818-2924

Detroit
Novi, MI
Tel: 248-848-4000

Houston, TX
Tel: 281-894-5983

Indianapolis
Noblesville, IN
Tel: 317-773-8323
Fax: 317-773-5453

Los Angeles
Mission Viejo, CA
Tel: 949-462-9523
Fax: 949-462-9608

New York, NY
Tel: 631-435-6000

San Jose, CA
Tel: 408-735-9110

Canada - Toronto
Tel: 905-673-0699
Fax: 905-673-6509

ASIA/PACIFIC

Asia Pacific Office
Suites 3707-14, 37th Floor
Tower 6, The Gateway
Harbour City, Kowloon
Hong Kong
Tel: 852-2943-5100
Fax: 852-2401-3431

Australia - Sydney
Tel: 61-2-9868-6733
Fax: 61-2-9868-6755

China - Beijing
Tel: 86-10-8569-7000
Fax: 86-10-8528-2104

China - Chengdu
Tel: 86-28-8665-5511
Fax: 86-28-8665-7889

China - Chongqing
Tel: 86-23-8980-9588
Fax: 86-23-8980-9500

China - Dongguan
Tel: 86-769-8702-9880

China - Hangzhou
Tel: 86-571-8792-8115
Fax: 86-571-8792-8116

China - Hong Kong SAR
Tel: 852-2943-5100
Fax: 852-2401-3431

China - Nanjing
Tel: 86-25-8473-2460
Fax: 86-25-8473-2470

China - Qingdao
Tel: 86-532-8502-7355
Fax: 86-532-8502-7205

China - Shanghai
Tel: 86-21-5407-5533
Fax: 86-21-5407-5066

China - Shenyang
Tel: 86-24-2334-2829
Fax: 86-24-2334-2393

China - Shenzhen
Tel: 86-755-8864-2200
Fax: 86-755-8203-1760

China - Wuhan
Tel: 86-27-5980-5300
Fax: 86-27-5980-5118

China - Xian
Tel: 86-29-8833-7252
Fax: 86-29-8833-7256

ASIA/PACIFIC

China - Xiamen
Tel: 86-592-2388138
Fax: 86-592-2388130

China - Zhuhai
Tel: 86-756-3210040
Fax: 86-756-3210049

India - Bangalore
Tel: 91-80-3090-4444
Fax: 91-80-3090-4123

India - New Delhi
Tel: 91-11-4160-8631
Fax: 91-11-4160-8632

India - Pune
Tel: 91-20-3019-1500

Japan - Osaka
Tel: 81-6-6152-7160
Fax: 81-6-6152-9310

Japan - Tokyo
Tel: 81-3-6880-3770
Fax: 81-3-6880-3771

Korea - Daegu
Tel: 82-53-744-4301
Fax: 82-53-744-4302

Korea - Seoul
Tel: 82-2-554-7200
Fax: 82-2-558-5932 or
82-2-558-5934

Malaysia - Kuala Lumpur
Tel: 60-3-6201-9857
Fax: 60-3-6201-9859

Malaysia - Penang
Tel: 60-4-227-8870
Fax: 60-4-227-4068

Philippines - Manila
Tel: 63-2-634-9065
Fax: 63-2-634-9069

Singapore
Tel: 65-6334-8870
Fax: 65-6334-8850

Taiwan - Hsin Chu
Tel: 886-3-5778-366
Fax: 886-3-5770-955

Taiwan - Kaohsiung
Tel: 886-7-213-7828

Taiwan - Taipei
Tel: 886-2-2508-8600
Fax: 886-2-2508-0102

Thailand - Bangkok
Tel: 66-2-694-1351
Fax: 66-2-694-1350

EUROPE

Austria - Wels
Tel: 43-7242-2244-39
Fax: 43-7242-2244-393

Denmark - Copenhagen
Tel: 45-4450-2828
Fax: 45-4485-2829

France - Paris
Tel: 33-1-69-53-63-20
Fax: 33-1-69-30-90-79

Germany - Dusseldorf
Tel: 49-2129-3766400

Germany - Munich
Tel: 49-89-627-144-0
Fax: 49-89-627-144-44

Germany - Pforzheim
Tel: 49-7231-424750

Italy - Milan
Tel: 39-0331-742611
Fax: 39-0331-466781

Italy - Venice
Tel: 39-049-7625286

Netherlands - Drunen
Tel: 31-416-690399
Fax: 31-416-690340

Poland - Warsaw
Tel: 48-22-3325737

Spain - Madrid
Tel: 34-91-708-08-90
Fax: 34-91-708-08-91

Sweden - Stockholm
Tel: 46-8-5090-4654

UK - Wokingham
Tel: 44-118-921-5800
Fax: 44-118-921-5820

01/27/15