

# Coaxial Amplifier

## ZX60-2522MA+

50Ω High Isolation 0.5 to 2.5 GHz

### Features

- From 2.8V to 5V operation
- Wide bandwidth, 0.5 to 2.5 GHz
- High active directivity
- Output power, up to 20 dBm typ.
- Protected by US patent 6,790,049

### Applications

- Buffer amplifier
- LO amplifiers for mixers
- Cellular
- PCN



CASE STYLE: GC957

Connectors	Model
SMA	ZX60-2522MA-S+

### +RoHS Compliant

The +Suffix identifies RoHS Compliance. See our web site for RoHS Compliance methodologies and qualifications

### Electrical Specifications $T_{AMB}=25^{\circ}\text{C}$

MODEL NO.	FREQ. (GHz)		DC VOLTS (V)	GAIN, dB Typical					Min. at 2 GHz	MAXIMUM POWER (dBm)		DYNAMIC RANGE			VSWR* (:1) Typ.		ACTIVE DIRECTIVITY (dB) (Isolation-Gain) Typ.		DC OPERATING CURRENT @ Pin V+ (mA)			
	$f_L$	$f_U$		over frequency, GHz						$f_L$	$f_U$	NF (dB) Typ.	IP3 (dBm) Typ.	at 1 GHz	at 1 GHz	at 2 GHz	In	Out	$f_L$	$f_U$	Typ	Max.
	0.5	2.5		0.5	1.0	1.5	2.0	2.5		20.5	19.5	2.6	32	30	1.4	1.3	21	13	94	110		
ZX60-2522MA+	0.5	2.5	5.0 2.8	22.6	25	25.2	24.3	22.6	21.5	20.5	19.5	2.6	32	30	1.4	1.3	21	13	94	110		
				20.9	22.6	22.6	21.3	19.9	—	12.5	14	2.6	24	25	1.4	1.4	24	14	88	—		

\* at 1.1 GHz - 2.5 GHz

### Maximum Ratings

Operating Temperature	-40°C to 85°C case
Storage Temperature	-55°C to 100°C
DC Voltage	7V at V+, 1V at input and output
Input Power (No damage)	10 dBm (continuous operation) 26 dBm (5 minutes max.)
Power Dissipation	970 mW

Permanent damage may occur if any of these limits are exceeded.

### Outline Drawing

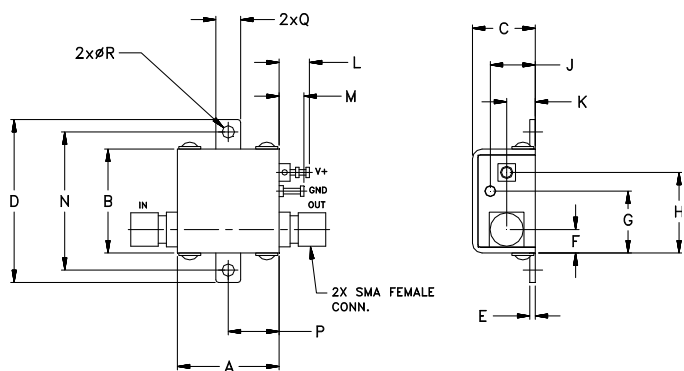

**!** NOTE: When soldering the DC connections, caution must be used to avoid overheating the DC terminal. See Application Note. [AN-40-010](#).

### Outline Dimensions (inch/mm)

A	B	C	D	E	F	G	H	J	K	L	M	N	P	Q	R	wt
.74	.75	.46	1.18	.04	.17	.45	.59	.33	.21	.22	.18	1.00	.37	.18	.106	grams
18.80	19.05	11.68	29.97	1.02	4.32	11.43	14.99	8.38	5.33	5.59	4.57	25.40	9.40	4.57	2.69	23.0

### Notes

- Performance and quality attributes and conditions not expressly stated in this specification document are intended to be excluded and do not form a part of this specification document.
- Electrical specifications and performance data contained in this specification document are based on Mini-Circuit's applicable established test performance criteria and measurement instructions.
- The parts covered by this specification document are subject to Mini-Circuits standard limited warranty and terms and conditions (collectively, "Standard Terms"); Purchasers of this part are entitled to the rights and benefits contained therein. For a full statement of the Standard Terms and the exclusive rights and remedies thereunder, please visit Mini-Circuits' website at [www.minicircuits.com/MCLStore/terms.jsp](http://www.minicircuits.com/MCLStore/terms.jsp)



[www.minicircuits.com](http://www.minicircuits.com) P.O. Box 350166, Brooklyn, NY 11235-0003 (718) 934-4500 sales@minicircuits.com

REV. A  
M166315  
ZX60-2522MA+  
RVN/TD/CP/AM  
180215  
Page 1 of 2

FREQUENCY (MHz)	GAIN (dB)		DIRECTIVITY (dB)		VSWR IN (:1)		VSWR OUT (:1)		POUT at 1 dB COMPR. (dBm)		NOISE FIGURE (dB)	
	2.8V	5V	2.8V	5V	2.8V	5V	2.8V	5V	2.8V	5V	2.8V	5V
500	20.70	22.49	26.16	22.95	2.75	2.99	1.89	1.75	12.36	20.94	3.25	3.18
600	21.63	23.63	25.18	22.99	2.19	2.33	1.66	1.50	12.79	21.13	2.97	2.88
700	22.08	24.25	23.92	22.42	1.88	1.96	1.53	1.33	12.78	21.04	2.88	2.78
800	22.31	24.61	22.53	21.86	1.70	1.73	1.44	1.22	13.12	21.11	2.77	2.68
900	22.43	24.85	21.41	21.06	1.58	1.59	1.40	1.13	12.80	20.72	2.71	2.65
1000	22.49	25.00	20.36	20.08	1.50	1.49	1.36	1.07	13.02	20.86	2.74	2.66
1100	22.51	25.10	19.71	19.35	1.45	1.42	1.35	1.03	13.28	20.86	2.68	2.60
1300	22.44	25.19	18.15	17.81	1.39	1.34	1.35	1.08	13.19	20.73	2.72	2.65
1500	22.27	25.13	17.00	16.50	1.36	1.30	1.36	1.14	13.11	20.56	2.69	2.60
1600	22.14	25.05	16.52	16.05	1.35	1.29	1.37	1.18	13.33	20.44	2.63	2.60
1800	21.82	24.76	15.79	15.36	1.35	1.29	1.39	1.22	13.54	20.27	2.71	2.64
2000	21.42	24.33	15.35	14.84	1.35	1.30	1.40	1.26	13.46	20.07	2.67	2.59
2200	20.94	23.75	14.83	14.77	1.36	1.32	1.41	1.28	13.62	19.81	2.64	2.58
2400	20.40	23.06	14.78	14.63	1.37	1.35	1.41	1.29	13.46	19.79	2.72	2.62
2500	20.11	22.69	14.66	14.66	1.38	1.37	1.40	1.29	13.71	19.77	2.79	2.69

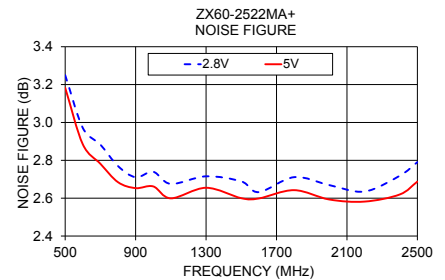
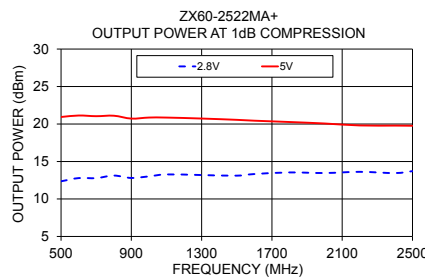
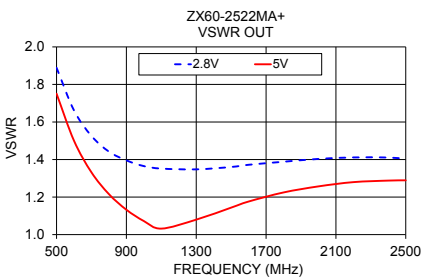
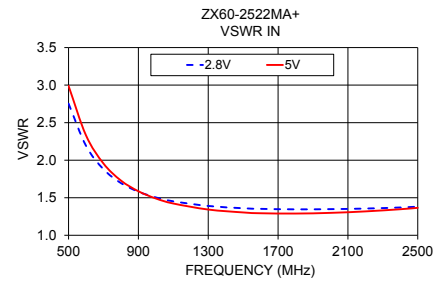
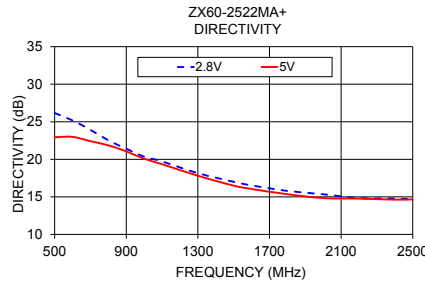
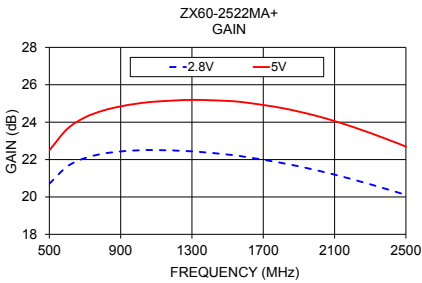

**Notes**

- A. Performance and quality attributes and conditions not expressly stated in this specification document are intended to be excluded and do not form a part of this specification document.
- B. Electrical specifications and performance data contained in this specification document are based on Mini-Circuit's applicable established test performance criteria and measurement instructions.
- C. The parts covered by this specification document are subject to Mini-Circuits standard limited warranty and terms and conditions (collectively, "Standard Terms"); Purchasers of this part are entitled to the rights and benefits contained therein. For a full statement of the Standard Terms and the exclusive rights and remedies thereunder, please visit Mini-Circuits' website at [www.minicircuits.com/MCLStore/terms.jsp](http://www.minicircuits.com/MCLStore/terms.jsp)

