

PTSM 0,5/ 4-HV-2,5-THR R32

Order No.: 1778573

<http://eshop.phoenixcontact.de/phoenix/treeViewClick.do?UID=1778573>

Header, Nominal current: 6 A, Rated voltage (III/2): 160 V, Number of positions: 4, Pitch: 2.5 mm, Color: black, Metal surface: Sn, Assembly: SMD/THT/THR

Commercial data

GTIN (EAN)	
sales group	E430
Pack	330 pcs.
Customs tariff	85369010
Catalog page information	Page 185 (NTK-2010)

Product notes

WEEE/RoHS-compliant since:
09/17/2009



<http://www.download.phoenixcontact.com>
Please note that the data given here has been taken from the online catalog. For comprehensive information and data, please refer to the user documentation. The General Terms and Conditions of Use apply to Internet downloads.

Technical data**Dimensions / positions**

Length	5 mm
Pitch	2.5 mm
Dimension a	7.5 mm
Number of positions	4

Pin dimensions	0,6 x 0,6 mm
Pin spacing	2.50 mm
Hole diameter	1.1 mm

Technical data

Range of articles	PTSM 0,5/..-HV-THR
Insulating material group	IIIa
Rated surge voltage (III/3)	2.5 kV
Rated surge voltage (III/2)	2.5 kV
Rated surge voltage (II/2)	2.5 kV
Rated voltage (III/2)	160 V
Rated voltage (II/2)	160 V
Connection in acc. with standard	EN-VDE
Nominal current I_N	6 A
Nominal voltage U_N	50 V
Maximum load current	6 A
Insulating material	LCP
Inflammability class acc. to UL 94	V0
Nominal voltage, UL/CUL Use Group B	150 V
Nominal current, UL/CUL Use Group B	6 A

Certificates / Approvals



Certification

CUL, UL

Diagrams/Drawings

Drilling plan/solder pad geometry

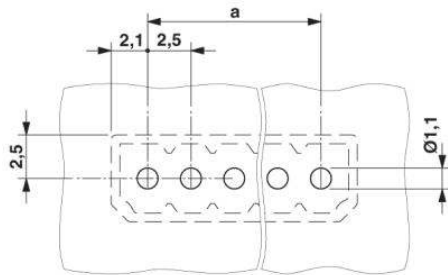

Dimensioned drawing

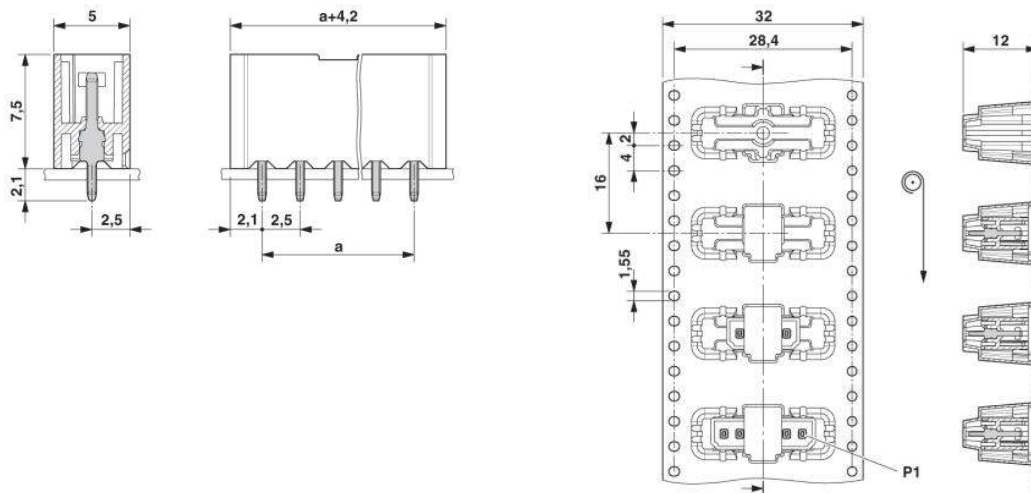

Address

PHOENIX CONTACT Inc., USA
586 Fulling Mill Road
Middletown, PA 17057, USA
Phone (800) 888-7388
Fax (717) 944-1625
<http://www.phoenixcon.com>



© 2011 Phoenix Contact
Technical modifications reserved;