

XBP4SMAJ Series

ETR29017-001

400W Transient Voltage Suppressor (TVS)

FEATURES

Bidirectional, Unidirectional, One Line

Package : SMA-PG

Environmentally Friendly : EU RoHS Compliant

APPLICATIONS

- Lighting
- Telecommunication
- Industrial

PIN CONFIGURATION

● Unidirectional

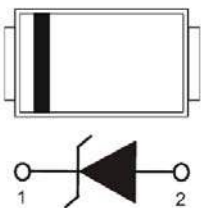

● Bidirectional

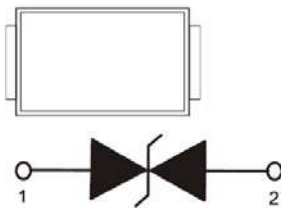

MARKING

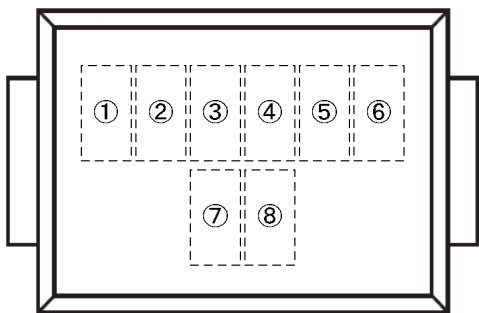

①②③④⑤⑥: Control Number

⑦⑧: Marking Code

PACKAGING INFORMATION

● SMA-PG

Unit: inch (mm)

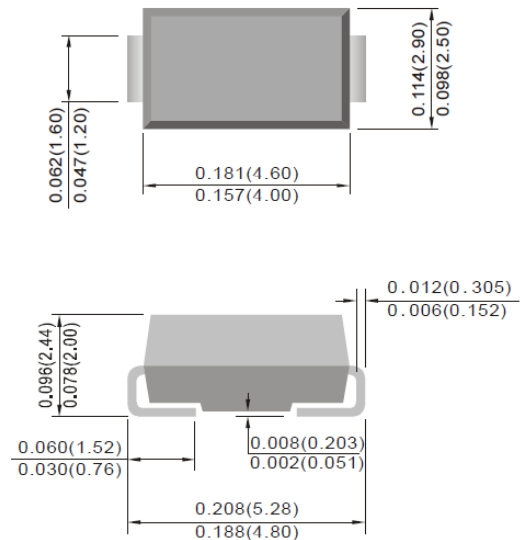

ABSOLUTE MAXIMUM RATINGS

Ta=25°C

PARAMETER	SYMBOL	RATINGS	UNITS
Peak Pulse Power ^{(*)1}	Ppk	400	W
Peak Pulse Current ^{(*)1}	Ipp	<E-1> ^{(*)2}	A
Non Continuous Forward Surge Current ^{(*)3}	I _{FSM}	40	A
Junction Temperature	T _j	150	°C
Storage Temperature	T _{stg}	-55 to 150	°C

^{(*)1} tp=10/1000μs^{(*)2} <E-1> See electrical characteristics.^{(*)3} 8.3ms single half sine wave for unidirectional device only, duty cycle=4per minute maximum.

PRODUCT NAME

● Unidirectional

PRODUCT NAME	MARKING CODE	PACKAGE	ORDER UNIT
XBP4SMAJ013A-G *	IG	SMA-PG	1,800pcs/Reel

* The "-G" suffix denotes Halogen and Antimony free as well as being fully EU RoHS compliant.

* The high-melting solder paste (lead-containing) is used as attachment.

● Bidirectional

PRODUCT NAME	MARKING CODE	PACKAGE	ORDER UNIT
XBP4SMAJ010C-G *	TX	SMA-PG	1,800pcs/Reel
XBP4SMAJ015C-G *	UM	SMA-PG	1,800pcs/Reel
XBP4SMAJ022C-G *	UX	SMA-PG	1,800pcs/Reel
XBP4SMAJ024C-G *	UZ	SMA-PG	1,800pcs/Reel

* The "-G" suffix denotes Halogen and Antimony free as well as being fully EU RoHS compliant.

* The high-melting solder paste (lead-containing) is used as attachment.

ELECTRICAL CHARACTERISTICS

● Unidirectional

Ta=25°C

PRODUCT NAME	PARAMETER					
	Stand-Off Voltage (V)	Breakdown Voltage (V)		Leakage Current (μA)	Clamping Voltage (V)	Peak Pulse Current (A) <E-1>
		V _{RWM}	V _{BR} ^{(*)1}		I _R ^{(*)2}	V _C ^{(*)3)(*)4}
		MIN.	MAX.	MAX.	MAX.	MAX.
XBP4SMAJ013A-G	13	14.4	16.5	1	21.5	18.6

^{(*)1} V_{BR}: Breakdown voltage measured at I_R=1mA.

^{(*)2} I_R: Leakage current measured at specified V_{RWM}.

^{(*)3} V_C: Clamping voltage measured at specified I_{PP}.

^{(*)4} tp=10/1000μs

● Bidirectional

Ta=25°C

PRODUCT NAME	PARAMETER					
	Stand-Off Voltage (V)	Breakdown Voltage (V)		Leakage Current (μA)	Clamping Voltage (V)	Peak Pulse Current (A) <E-1>
		V _{RWM}	V _{BR} ^{(*)1}		I _R ^{(*)2}	V _C ^{(*)3)(*)4}
		MIN.	MAX.	MAX.	MAX.	MAX.
XBP4SMAJ010C-G	10	11.1	12.8	5	17.0	23.5
XBP4SMAJ015C-G	15	16.7	19.2	1	24.4	16.4
XBP4SMAJ022C-G	22	24.4	28.0	1	35.5	11.2
XBP4SMAJ024C-G	24	26.7	30.7	1	38.9	10.3

^{(*)1} V_{BR}: Breakdown voltage measured at I_R=1mA.

^{(*)2} I_R: Leakage current measured at specified V_{RWM}.

^{(*)3} V_C: Clamping voltage measured at specified I_{PP}.

^{(*)4} tp=10/1000μs

■ NOTES ON USE

1. Please use this IC within the absolute maximum ratings.

Even within the ratings, in case of high load use continuously such as high temperature, high voltage, high current and thermal stress may cause reliability degradation of the IC.

2. Torex places an importance on improving our products and their reliability.

We request that users incorporate fail-safe designs and post-aging protection treatment when using Torex products in their systems.

■ REFERENCE PATTERN LAYOUT

● SMA-PG

Unit: inch (mm)

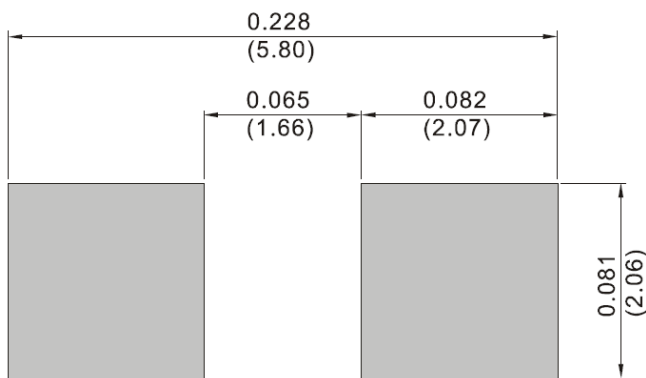

TAPING SPECIFICATIONS

● SMA-PG

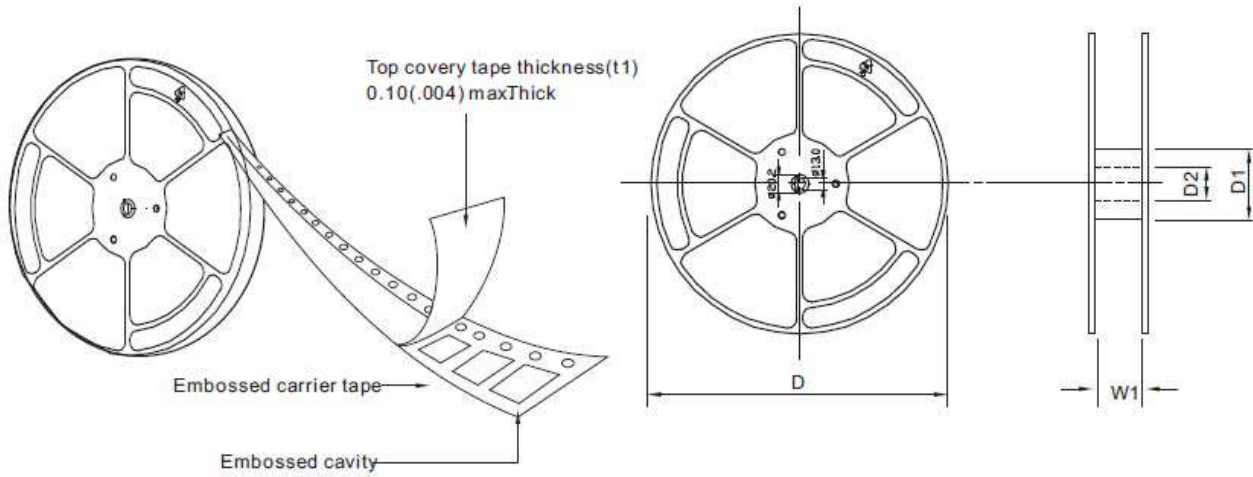
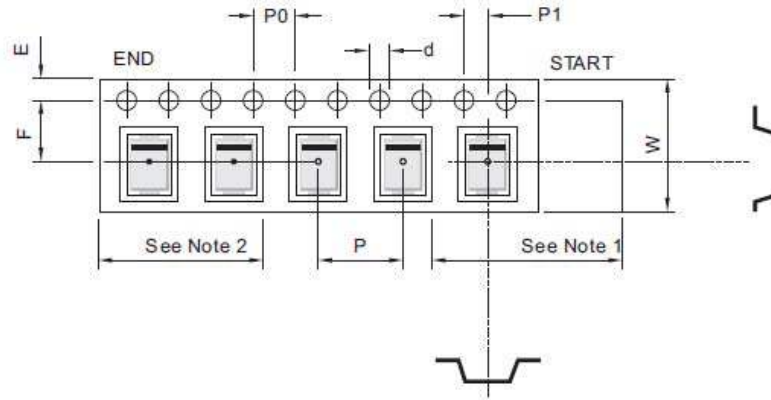

Note:

1. There shall be leader of 230mm minimum which may consist of carrier and or cover tape follower by a minimum of 160mm of carrier tape sealed with cover tape.
2. There shall be minimum of 160mm of empty component pockets sealed with cover tape.

SYMBOL	mm
d	1.55 ± 0.05
D	178.0 ± 2.0
D1	MIN. 50.0
D2	13.0 ± 0.2
E	1.75 ± 0.10
F	5.50 ± 0.10
P	4.00 ± 0.10
P0	4.00 ± 0.10
P1	2.00 ± 0.10
W	12.0 ± 0.3
W1	13.4 ± 1.0

1. The product and product specifications contained herein are subject to change without notice to improve performance characteristics. Consult us, or our representatives before use, to confirm that the information in this datasheet is up to date.
2. The information in this datasheet is intended to illustrate the operation and characteristics of our products. We neither make warranties or representations with respect to the accuracy or completeness of the information contained in this datasheet nor grant any license to any intellectual property rights of ours or any third party concerning with the information in this datasheet.
3. Applicable export control laws and regulations should be complied and the procedures required by such laws and regulations should also be followed, when the product or any information contained in this datasheet is exported.
4. The product is neither intended nor warranted for use in equipment of systems which require extremely high levels of quality and/or reliability and/or a malfunction or failure which may cause loss of human life, bodily injury, serious property damage including but not limited to devices or equipment used in 1) nuclear facilities, 2) aerospace industry, 3) medical facilities, 4) automobile industry and other transportation industry and 5) safety devices and safety equipment to control combustions and explosions. Do not use the product for the above use unless agreed by us in writing in advance.
5. Although we make continuous efforts to improve the quality and reliability of our products; nevertheless Semiconductors are likely to fail with a certain probability. So in order to prevent personal injury and/or property damage resulting from such failure, customers are required to incorporate adequate safety measures in their designs, such as system fail safes, redundancy and fire prevention features.
6. Our products are not designed to be Radiation-resistant.
7. Please use the product listed in this datasheet within the specified ranges.
8. We assume no responsibility for damage or loss due to abnormal use.
9. All rights reserved. No part of this datasheet may be copied or reproduced unless agreed by Torex Semiconductor Ltd in writing in advance.

TOREX SEMICONDUCTOR LTD.