

THIS DRAWING IS UNPUBLISHED. RELEASED FOR PUBLICATION
 © COPYRIGHT BY TYCO ELECTRONICS CORPORATION. ALL RIGHTS RESERVED.

| LOC | DIST | REVISIONS | | | |
|-----|------|-------------|------------------------|-----------|---------|
| P | LTR | DESCRIPTION | DATE | DWN | APVD |
| DW | — | A2 | RELEASED ECR 16-007769 | 20JUN2016 | J.J W.H |

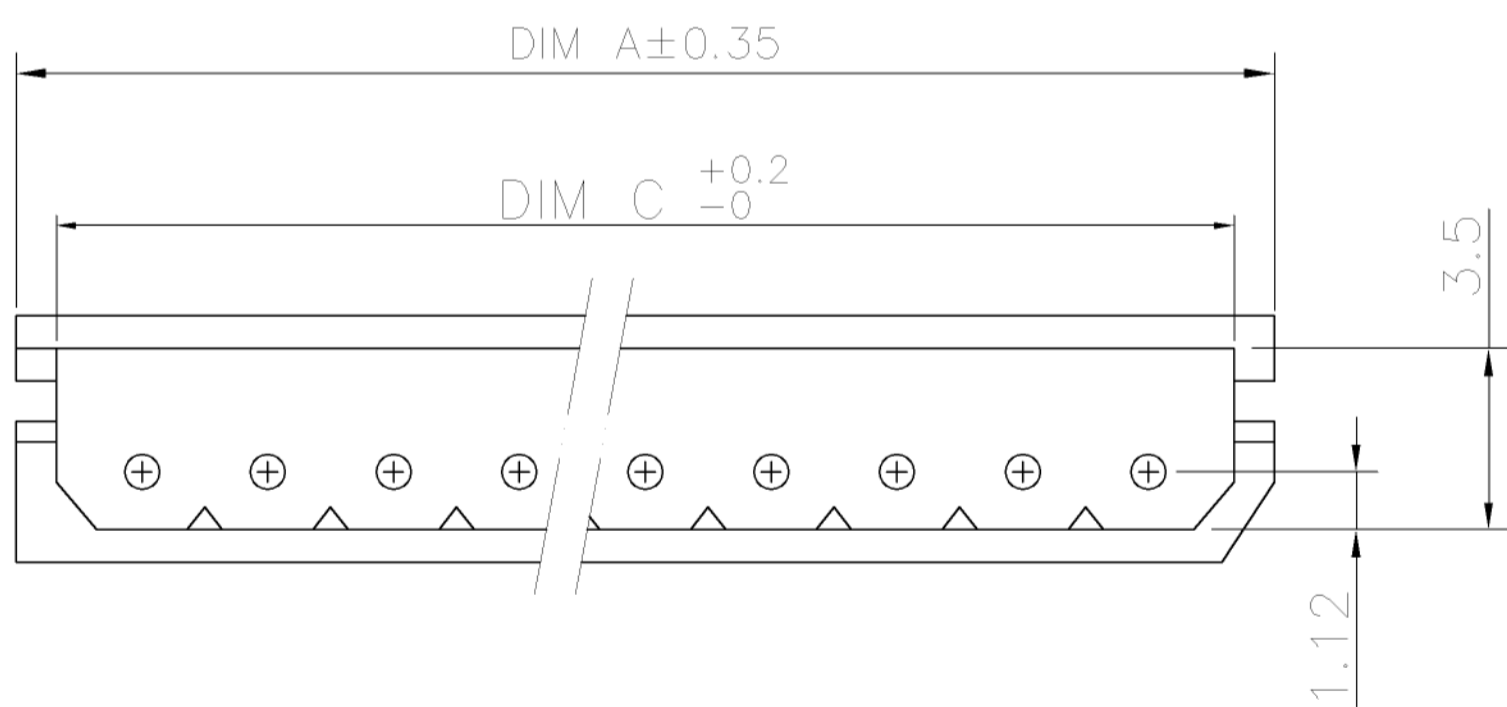
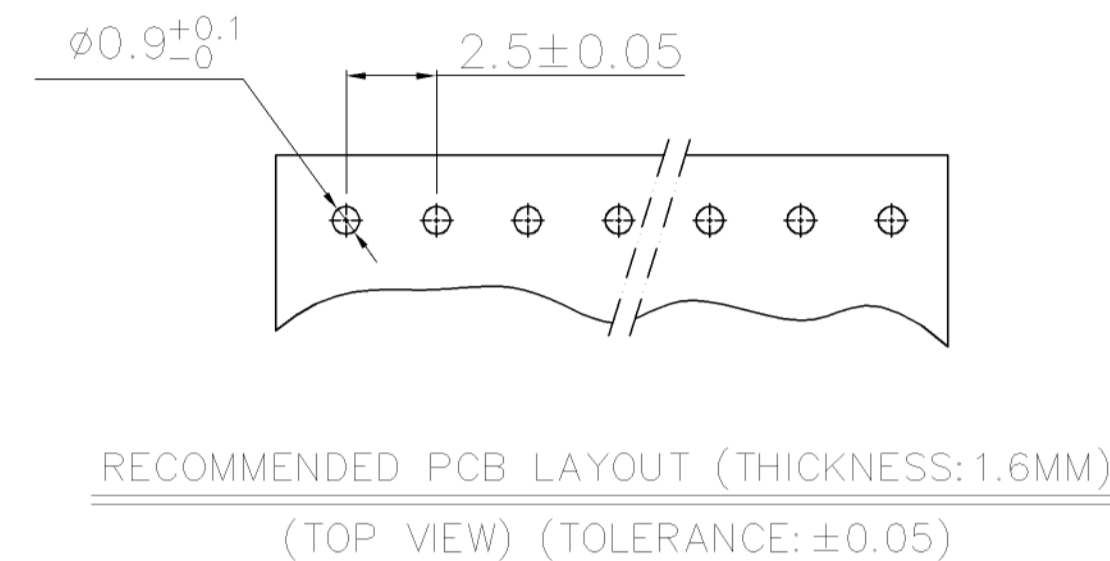
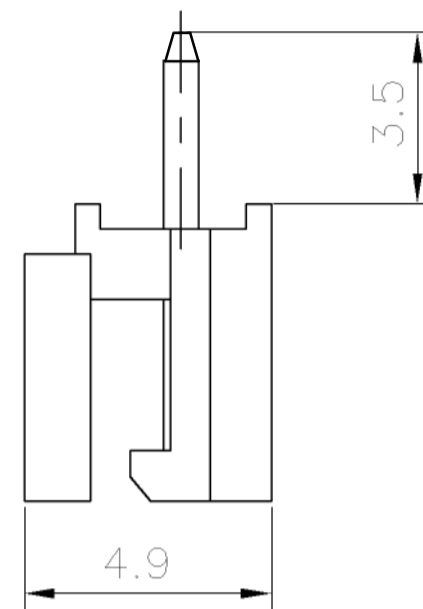
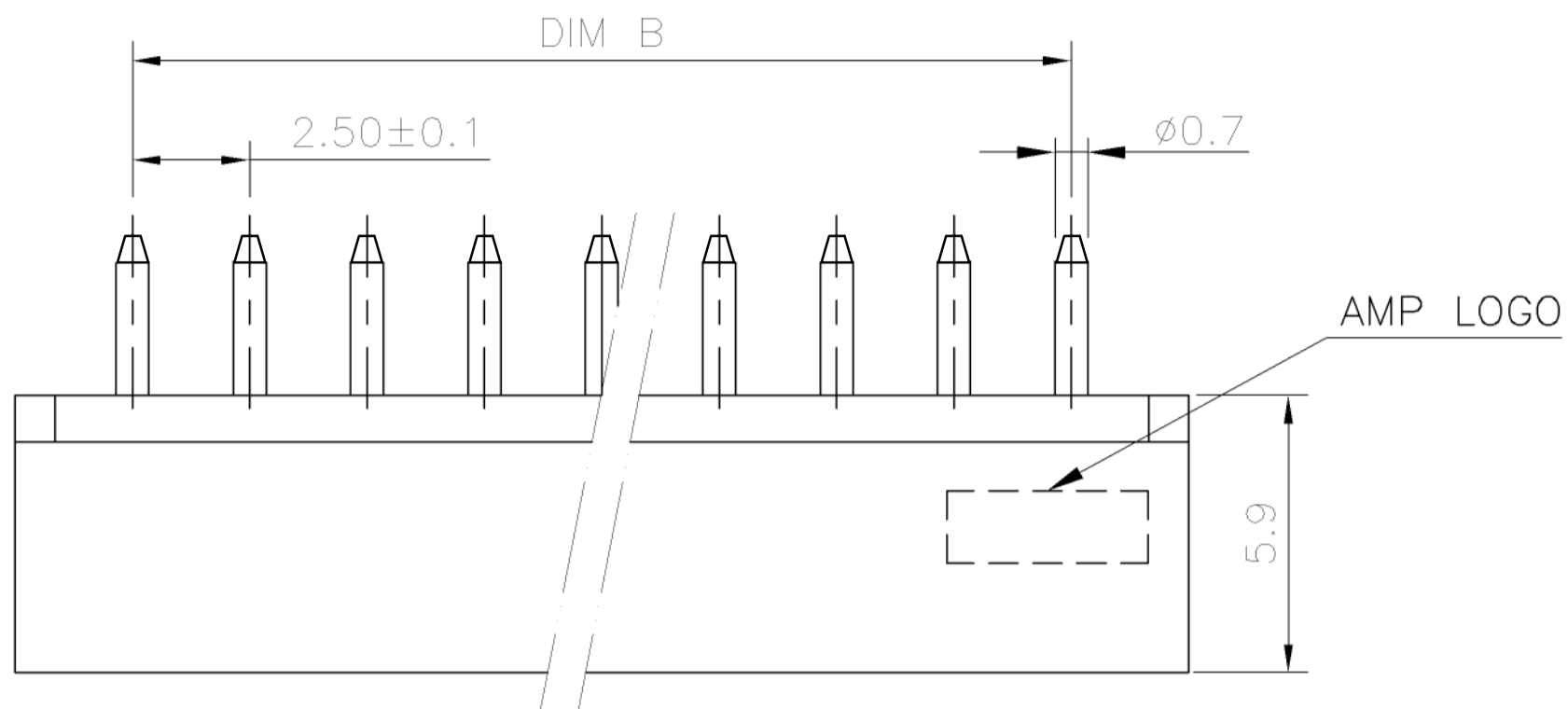

NOTE:

- MATERIAL :
HOUSING : PA46, 30%GF, UL 94-V0, COLOR: SEE TABLE
CONTACT : BRASS, THICKNESS=Ø0.7mm.
- FINISH:
CONTACT: 2µm [80µ"] MIN. BRIGHT-TIN ON SOLDER TAIL, WITH ENTIRE CONTACT UNDERPLATED 0.75µm [30µ"] MIN. NICKEL.
- WAVE SOLDER CAPABLE TO 265°C PER TE TEST SPEC. 109-202, CONDITION B.

| HSG. COLOR | DIM C | DIM B | DIM A | POS. | PART NUMBER |
|------------|-------|------------|-------|------|-------------|
| BLUE | 10.9 | 7.50 ±0.10 | 12.5 | 4 | 2-1775284-4 |
| | 8.4 | 5.00 ±0.10 | 10.0 | 3 | 2-1775284-3 |
| | 5.9 | 2.50 ±0.10 | 7.5 | 2 | 2-1775284-2 |
| IVORY | 10.9 | 7.50 ±0.10 | 12.5 | 4 | 0-1775284-4 |
| | 8.4 | 5.00 ±0.10 | 10.0 | 3 | 0-1775284-3 |
| | 5.9 | 2.50 ±0.10 | 7.5 | 2 | 0-1775284-2 |

| | | | | | |
|--|--|--|---|--------------------|-------------------------|
| THIS DRAWING IS A CONTROLLED DOCUMENT. | | DWN O. WU 26SEP2007 | Tyco Electronics Corporation Taipei, Taiwan | | |
| DIMENSIONS: MM | | CHK S. HOU 26SEP2007 | | | |
| TOLERANCES UNLESS OTHERWISE SPECIFIED: | | APVD W.J. KE 26SEP2007 | NAME | | |
| 0 PLC ± 0.50 1 PLC ± 0.20 2 PLC ± 0.10 3 PLC ± 0.05 4 PLC ± - ANGLES ± 3° | | PRODUCT SPEC 108-57175 | 2.5mm PITCH EMIX POST, HEADER, VERTICAL TYPE | | |
| MATERIAL SEE NOTE | | QUALIFICATION TEST REPORT 501-57195 | SIZE A3 | CAGE CODE 00779 | DRAWING NO C=1775284 |
| FINISH SEE NOTE | | WEIGHT -- | RESTRICTED TO -- | | SCALE -- |
| CUSTOMER DRAWING | | | SHEET 1 OF 2 | REV A2 | |

THIS DRAWING IS UNPUBLISHED. RELEASED FOR PUBLICATION
 © COPYRIGHT BY TYCO ELECTRONICS CORPORATION. ALL RIGHTS RESERVED.

| LOC | DIST | REVISIONS | | | | | |
|-----|------|-----------|-----|--------------|------|-----|------|
| DW | — | P | LTR | DESCRIPTION | DATE | DWN | APVD |
| | | | | SEE SHEET 1. | | | |

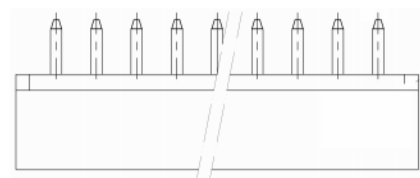

CONNECTOR

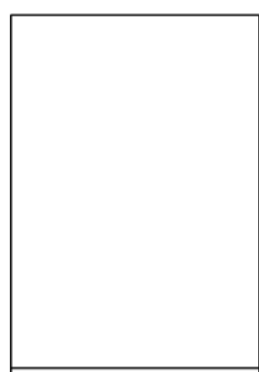

BAG

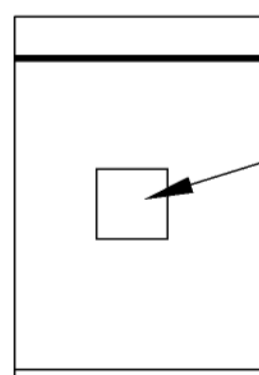

LABEL

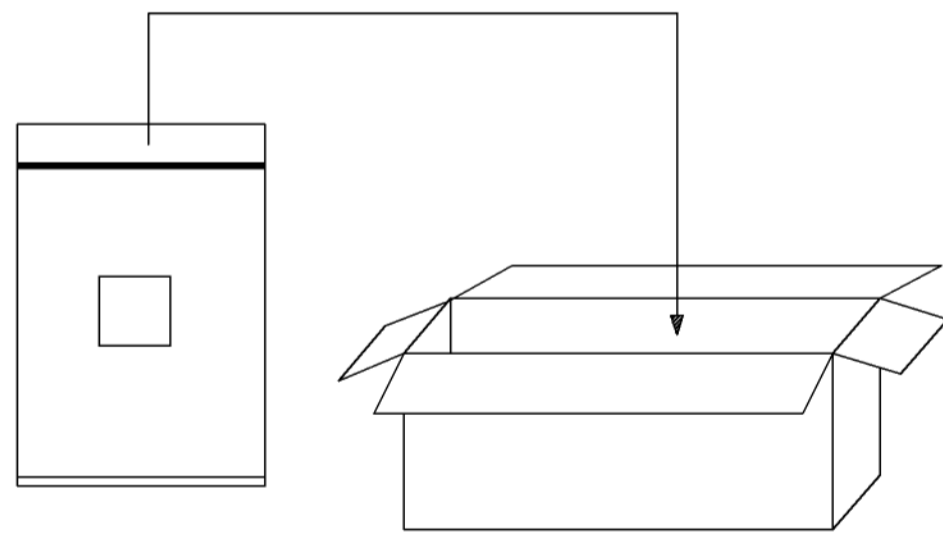

SHIPPING BOX

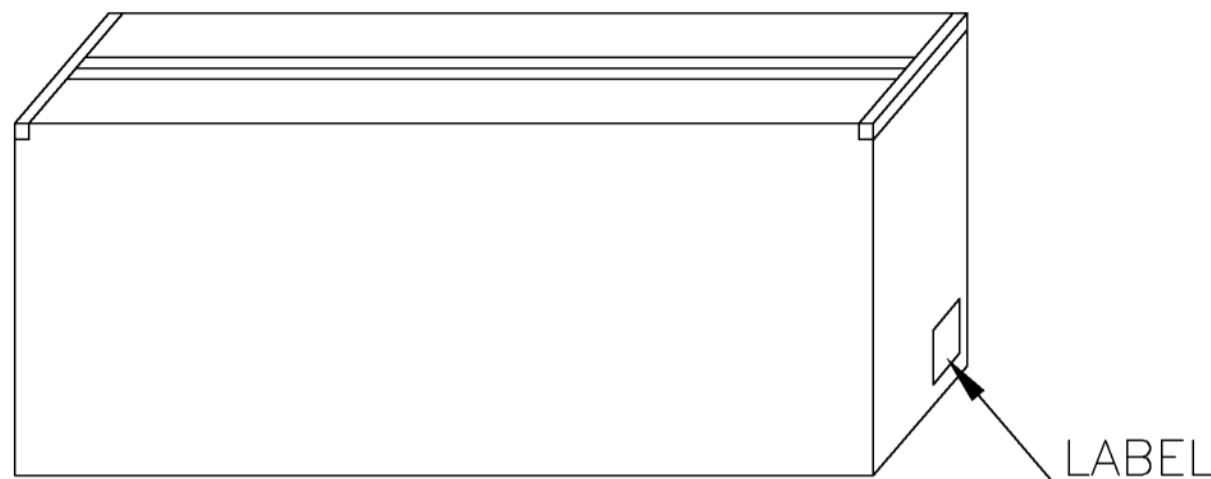

LABEL

| -24,000 | 600 | 2-1775284-4 | 0-1775284-4 |
|------------------|------------------|-------------|-------------|
| 30,000 | 750 | 2-1775284-3 | 0-1775284-3 |
| -36,000 | 1000 | 2-1775284-2 | 0-1775284-2 |
| APQ (PCS/BOX) | PPQ (PCS/BAG) | PART NUMBER | |

| | | | | | | | | | | | | | |
|--|--|--|--------|--------------|--|------------------|--|---|-----------|------------|---------------|-----|----|
| THIS DRAWING IS A CONTROLLED DOCUMENT. | | DWN | O. WU | 26SEP2007 | Tyco Electronics Corporation Taipei, Taiwan | | | | | | | | |
| DIMENSIONS: MM | | CHK | S. HOU | 26SEP2007 | | | | NAME | | | | | |
| | | TOLERANCES UNLESS OTHERWISE SPECIFIED: | | APVD | | 26SEP2007 | | 2.5mm PITCH EMIX POST, HEADER, VERTICAL TYPE | | | | | |
| MATERIAL | | FINISH | | PRODUCT SPEC | | APPLICATION SPEC | | SIZE | CAGE CODE | DRAWING NO | RESTRICTED TO | | |
| - | | - | | - | | - | | A3 | 00779 | C=1775284 | - | | |
| CUSTOMER DRAWING | | | | | | | | SCALE | - | SHEET | 2 OF 2 | REV | A2 |

THIS DRAWING IS UNPUBLISHED. RELEASED FOR PUBLICATION
 © COPYRIGHT BY TYCO ELECTRONICS CORPORATION. ALL RIGHTS RESERVED.

| LOC | DIST | REVISIONS | | | | | |
|-----|------|-----------|-----|--------------|------|-----|------|
| DW | — | P | LTR | DESCRIPTION | DATE | DWN | APVD |
| | | | | SEE SHEET 1. | | | |

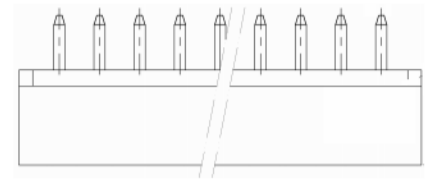

CONNECTOR

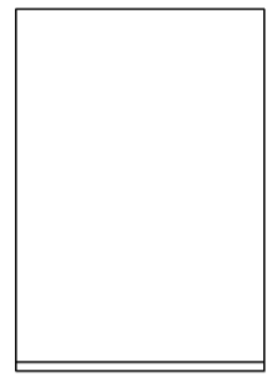

BAG

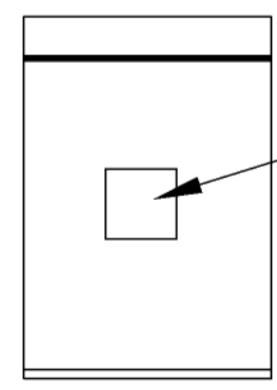

LABEL

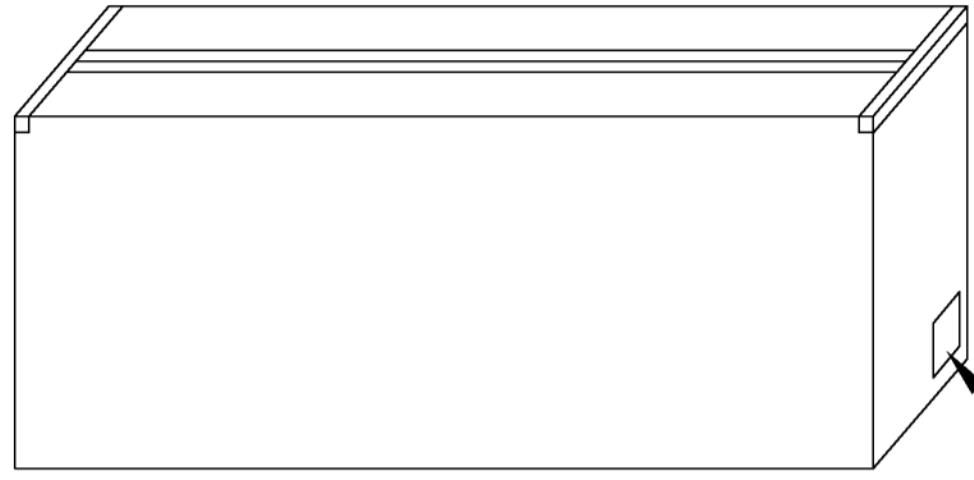

LABEL

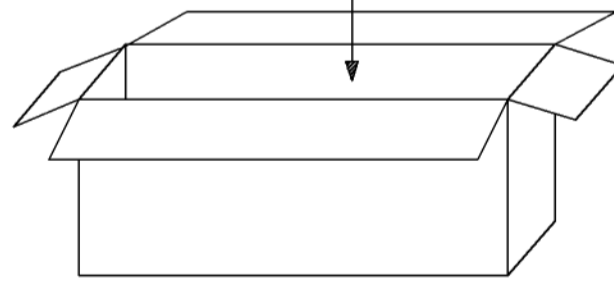
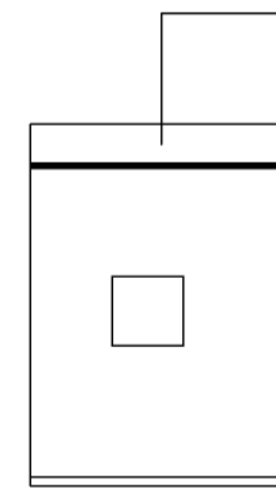

SHIPPING BOX

| -24,000 | 600 | 2-1775284-4 | 0-1775284-4 |
|------------------|------------------|-------------|-------------|
| 30,000 | 750 | 2-1775284-3 | 0-1775284-3 |
| -36,000 | 1000 | 2-1775284-2 | 0-1775284-2 |
| APQ (PCS/BOX) | PPQ (PCS/BAG) | PART NUMBER | |

| | | | | | | | | | | | | | |
|--|--|--|--------|--------------|--|------------------|--|--|-----------|------------|---------------|-----|----|
| THIS DRAWING IS A CONTROLLED DOCUMENT. | | DWN | O. WU | 26SEP2007 | Tyco Electronics Corporation Taipei, Taiwan | | | | | | | | |
| DIMENSIONS: MM | | CHK | S. HOU | 26SEP2007 | | | | NAME | | | | | |
| | | TOLERANCES UNLESS OTHERWISE SPECIFIED: | | APVD | | 26SEP2007 | | 2.5mm PITCH EMIX POST, HEADER, VERTICAL TYPE | | | | | |
| MATERIAL | | FINISH | | PRODUCT SPEC | | APPLICATION SPEC | | SIZE | CAGE CODE | DRAWING NO | RESTRICTED TO | | |
| - | | - | | - | | - | | A3 | 00779 | C=1775284 | - | | |
| CUSTOMER DRAWING | | | | | | | | SCALE | - | SHEET | 2 OF 2 | REV | A2 |