

Device Features

- +33.9 dBm Input IP3
- 8.3dB Conversion Loss
- Integrated LO Driver
- -2 to +4dBm LO drive level
- Available 3.3V to 5V single voltage
- MSL 1, MSOP 8, Green / RoHS2 compliant
- ESD HBM Class 1B



Product Description

The BM851 is a high linearity and dynamic covering range from 1.7GHz to 2.7GHz on 3.3V to 5V with a passive GaAs FET converter and two stage LO driver. This is packaged in a plastic surface mountable MSOP8 with Lead-free / Green / RoHS2 compliant. Typical Input IP3 and Conversion loss are 33.9dBm and 8.3dB, respectively. All devices are 100% RF/DC screened.

Functional Block Diagram

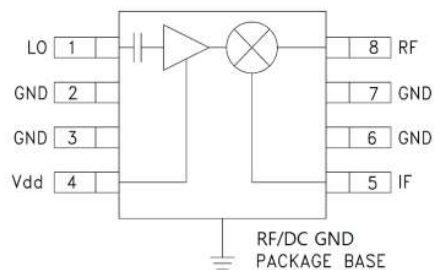

Applications

- Base station /Repeaters Infrastructure/Small Cell
- Commercial/Industrial/Military wireless system
- LTE / WCDMA /CDMA Wireless Infrastructure

Application Circuit

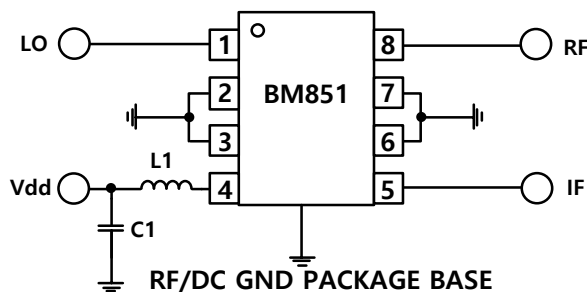

Bom	Value	Remark
C1	1nF	
L1	56nH	

* Note

- See page 11 for SMT

Recommended Operating Conditions

Parameter	Min.	Typical	Max.	Unit
Bandwidth	1700		2700	MHz
I_d @ (Vd = 5.0V)	52	57.5	64	mA
I_d @ (Vd = 3.3V)	40	44.5	50	mA
R_{TH}		99.0		°C/W
Operating Case Temperature	-40		+85	°C

Typical Performance¹

Test condition _ Measured on BeRex E/B at 25°C, 50ohm system, Vdd=5V Ids=57.5mA

Parameter	Min	Typ	Max	Min	Typ	Max	Min	Typ	Max	Min	Typ	Max	Min	Typ	Max	Units
RF Frequency Range	1700 ~ 1800			1800 ~ 2000			2000 ~ 2200			2200 ~ 2400			2500 ~ 2700			MHz
LO Frequency Range	1400 ~ 1750			1500 ~ 1950			1700 ~ 2150			1900 ~ 2350			2200 ~ 2650			MHz
IF Frequency Range	50 ~ 300			50 ~ 300			50 ~ 300			50 ~ 300			50 ~ 300			MHz
SSB Conversion Loss		8.3			8.1			8.3			8.8			10.0		dB
Input IP3 ²		32.0			32.8			33.9			32.3			30.3		dBm
LO Leakage RF Port		-12.7			-9.1			-6.0			-4.6			-5.1		dBm
LO Leakage IF Port		-8.7			-14.0			-15.9			-13.0			-10.6		dBm
RF-IF Isolation		-16.6			-20.2			-17.8			-14.0			-10.6		dB
RF Return Loss		-11.5			-13.2			-15.5			-16.6			-15.7		dB
IF Return Loss		-9.2			-9.6			-11.8			-15.1			-24.3		dB
Input P1dB		23.8			23.0			23.0			22.0			20.8		dBm
LO Drive Level	-2	0	+4	-2	0	+4	-2	0	+4	-2	0	+4	-2	0	+4	dBm

Test condition _ Measured on BeRex E/B at 25°C, 50ohm system, Vdd=3.3V Ids= 44.5mA

Parameter	Min	Typ	Max	Min	Typ	Max	Min	Typ	Max	Min	Typ	Max	Min	Typ	Max	Units
RF Frequency Range	1700 ~ 1800			1800 ~ 2000			2000 ~ 2200			2200 ~ 2400			2500 ~ 2700			MHz
LO Frequency Range	1400 ~ 1750			1500 ~ 1950			1700 ~ 2150			1900 ~ 2350			2200 ~ 2650			MHz
IF Frequency Range	50 ~ 300			50 ~ 300			50 ~ 300			50 ~ 300			50 ~ 300			MHz
SSB Conversion Loss		8.3			8.2			8.2			8.7			10.0		dB
Input IP3 ²		27.6			30.3			31.5			28.1			24.3		dBm
LO Leakage RF Port		-14.0			-12.2			-11.0			-10.9			-10.5		dBm
LO Leakage IF Port		-12.6			-18.4			-20.5			-18.2			-15.6		dBm
RF-IF Isolation		-16.5			-20.5			-18.1			-14.6			-11.0		dB
RF Return Loss		-11.6			-12.4			-13.3			-13.5			-14.5		dB
IF Return Loss		-11.1			-11.5			-14.2			-18.0			-16.7		dB
Input P1dB		19.1			18.8			17.8			15.3			13.1		dBm
LO Drive Level	-2	0	+4	-2	0	+4	-2	0	+4	-2	0	+4	-2	0	+4	dBm

¹ Specifications show on 0dBm-LO driven power and 150 MHz-IF frequency in a down converting configuration with high-side LO.

² IIP3 is measured on two tone with RF in power 0dBm/ tone , F2—F1 = 1 MHz..

Absolute Maximum Ratings

Parameter	Rating	Unit
Storage Temperature	-55 to +155	°C
Junction Temperature	+180	°C
Supply Voltage	+7	V
LO Power	+10	dBm
Input RF/IF Power	+25	dBm

Operation of this device above any of these parameters may result in permanent damage.

Typical Test Data

Test condition _ Measured on BeRex E/B at 25°C, 50ohm system, Vdd=5V, Ids=57.5mA , Down converting

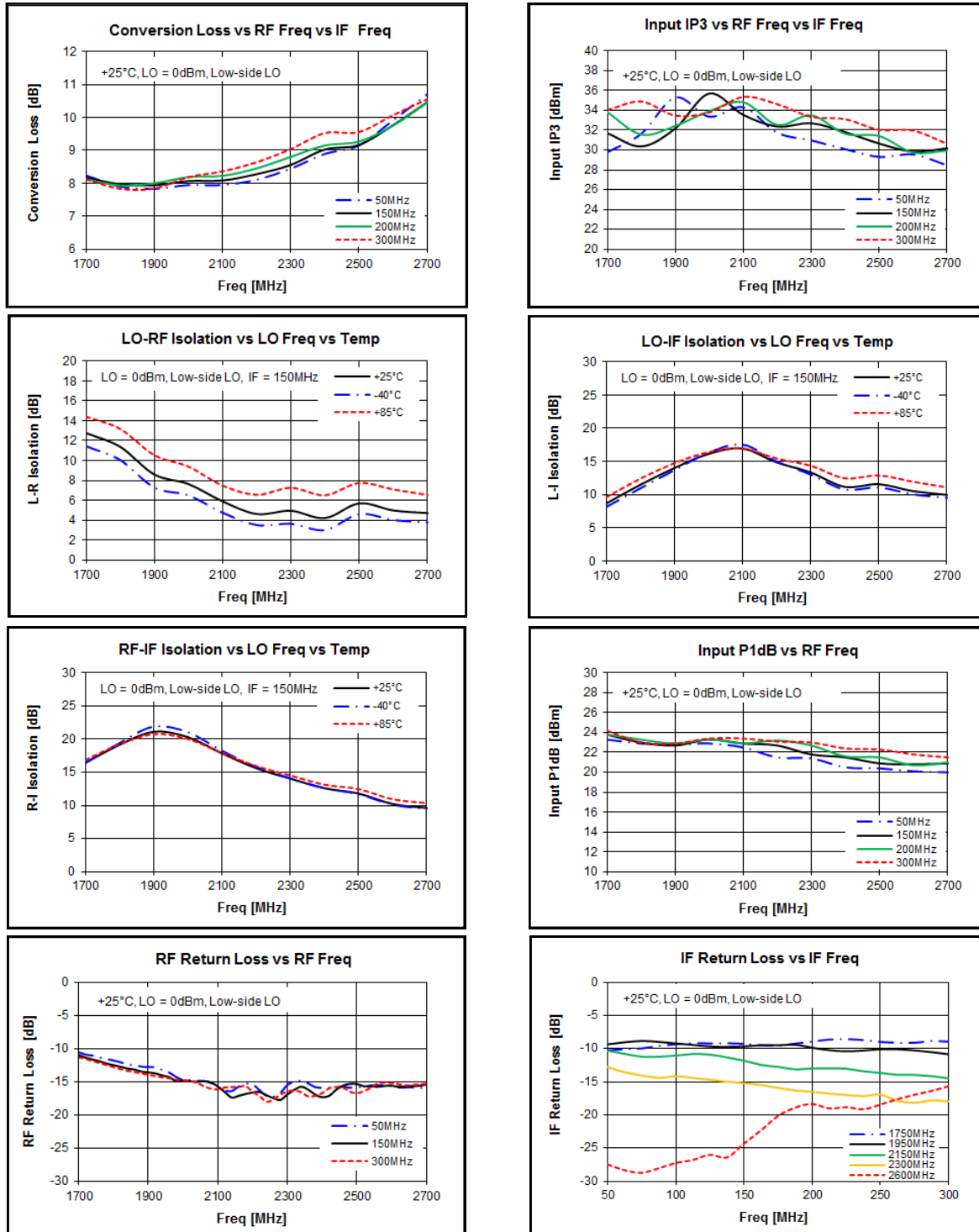

Typical Test Data

Test condition _ Measured on BeRex E/B at 25°C, 50ohm system, Vdd=5V, Ids=57.5mA , Down converting

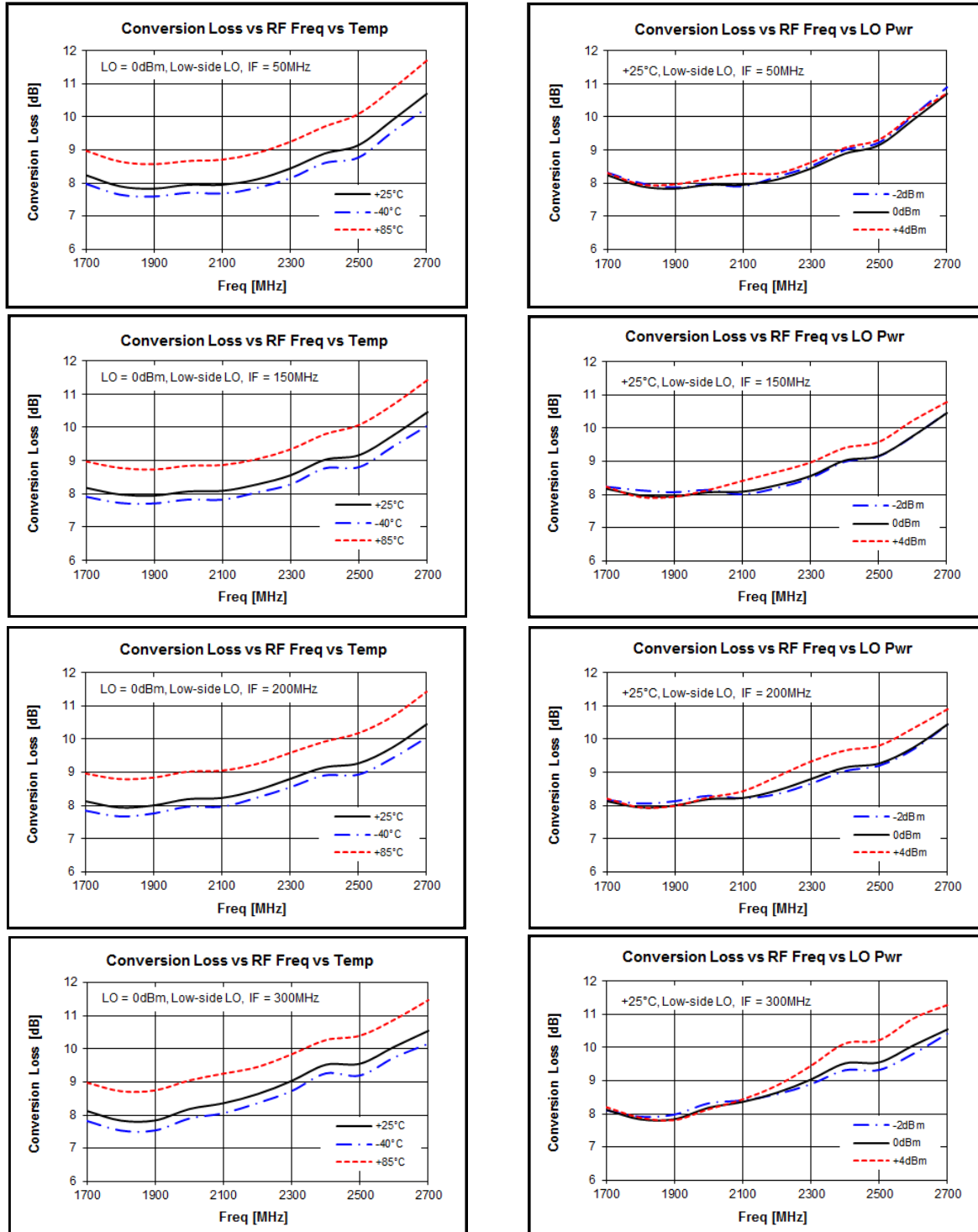

Typical Test Data

Test condition _ Measured on BeRex E/B at 25°C, 50ohm system, Vdd=5V, Ids=57.5mA , Down converting

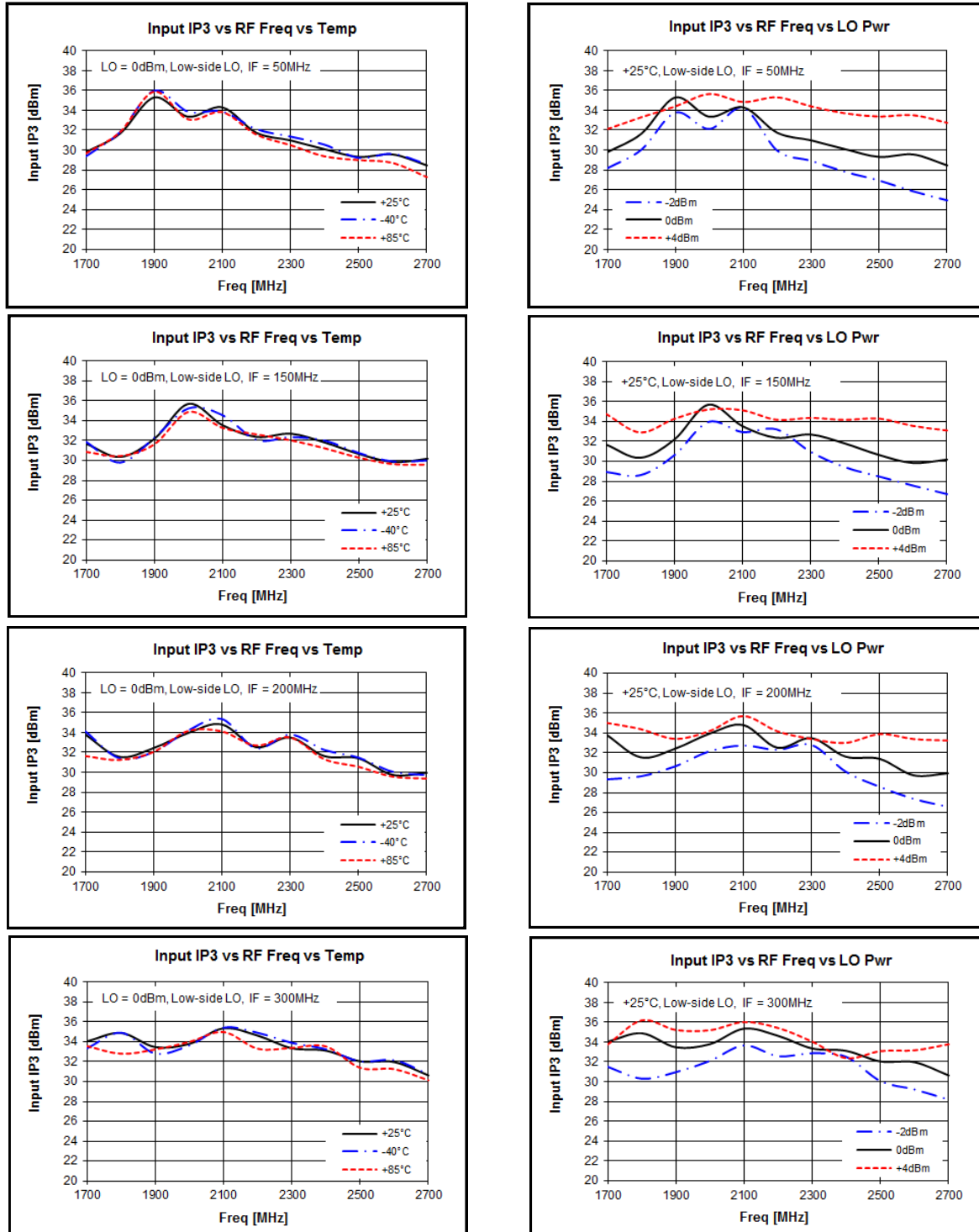

Typical Test Data

Test condition _ Measured on BeRex E/B at 25°C, 50ohm system, Vdd=3.3V, Ids=44.5mA, Down converting

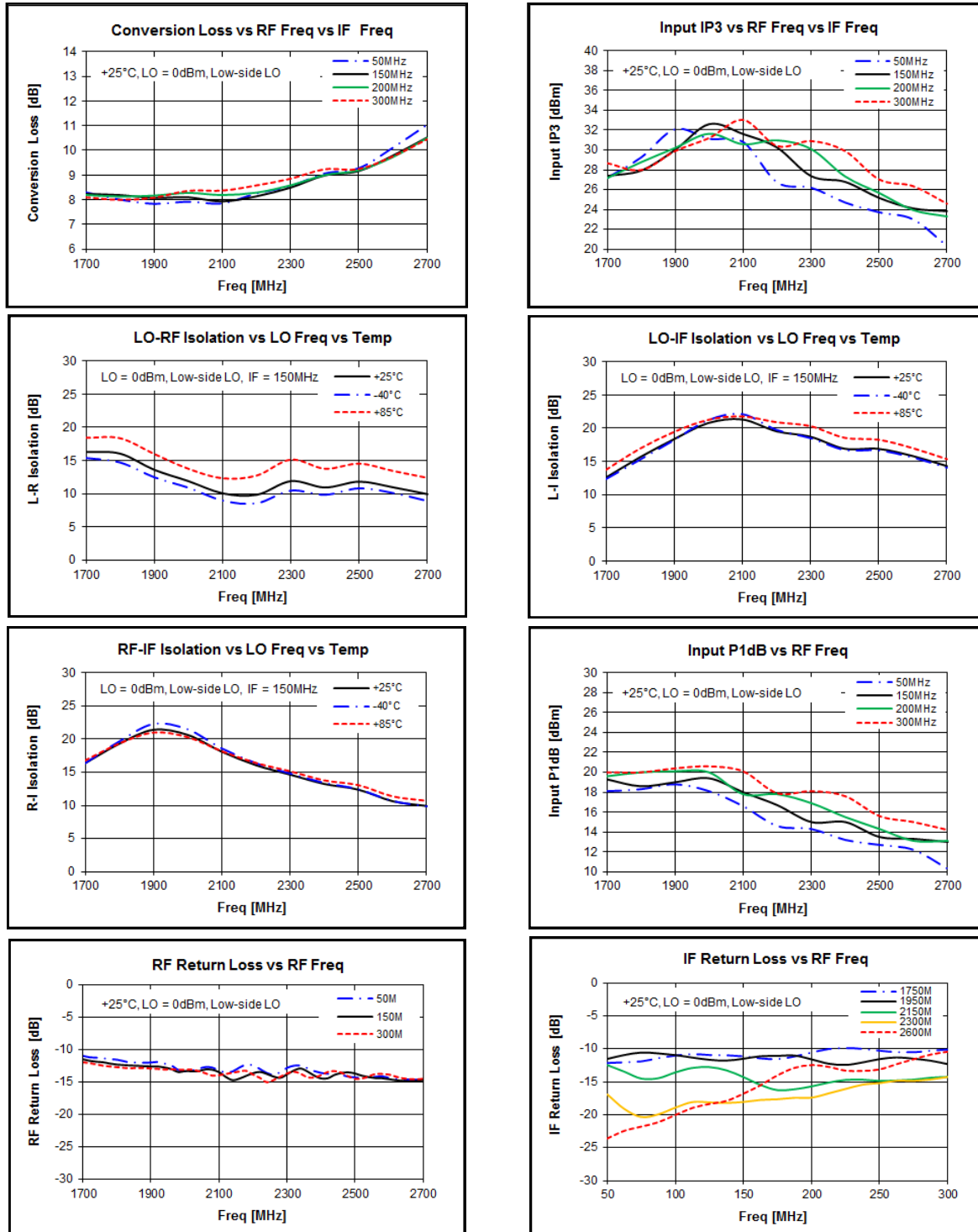

Typical Test Data

Test condition _ Measured on BeRex E/B at 25°C, 50ohm system, Vdd=3.3V, Ids=44.5mA, Down converting

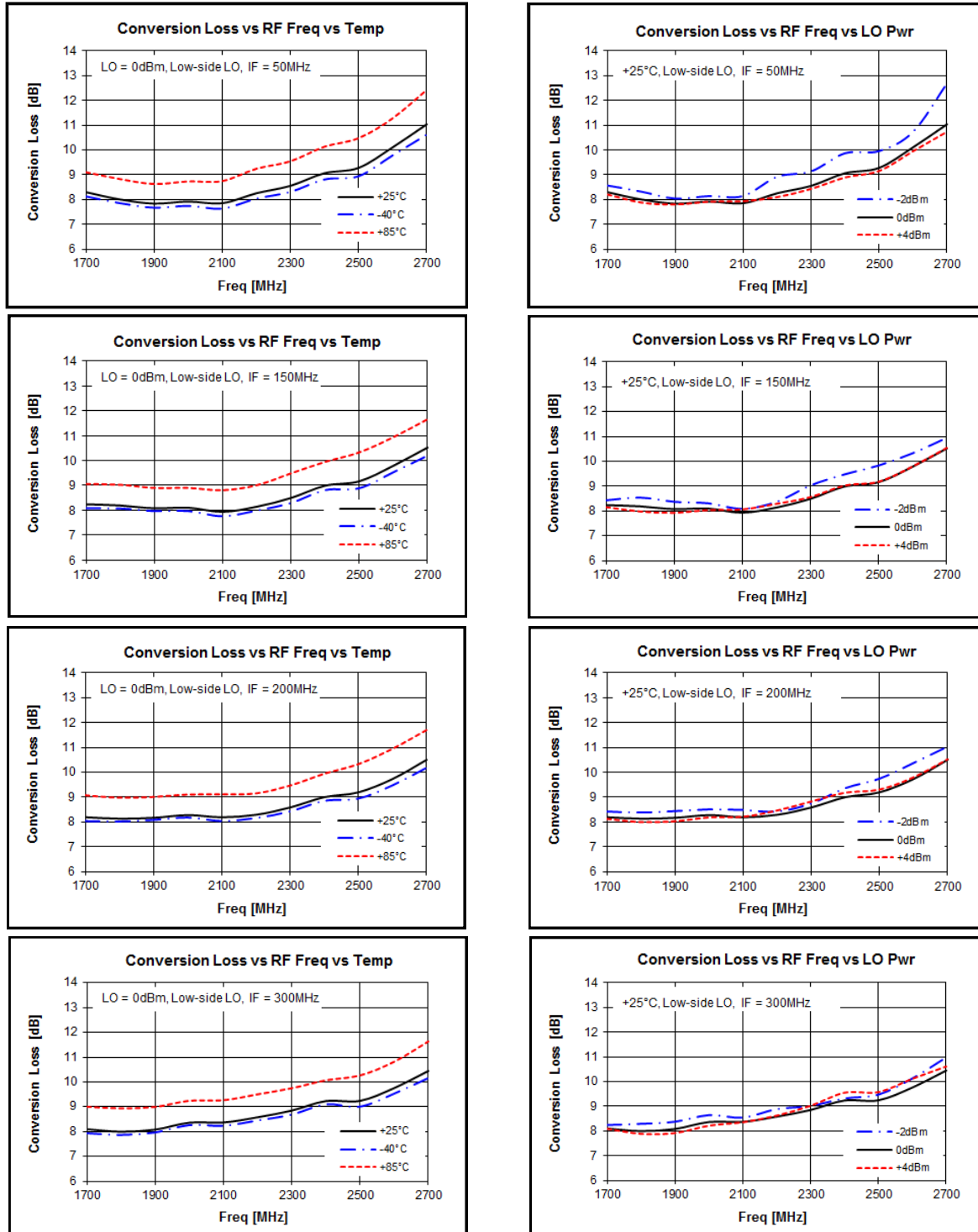

Typical Test Data

Test condition _ Measured on BeRex E/B at 25°C, 50ohm system, Vdd=3.3V, Ids=44.5mA, Down converting

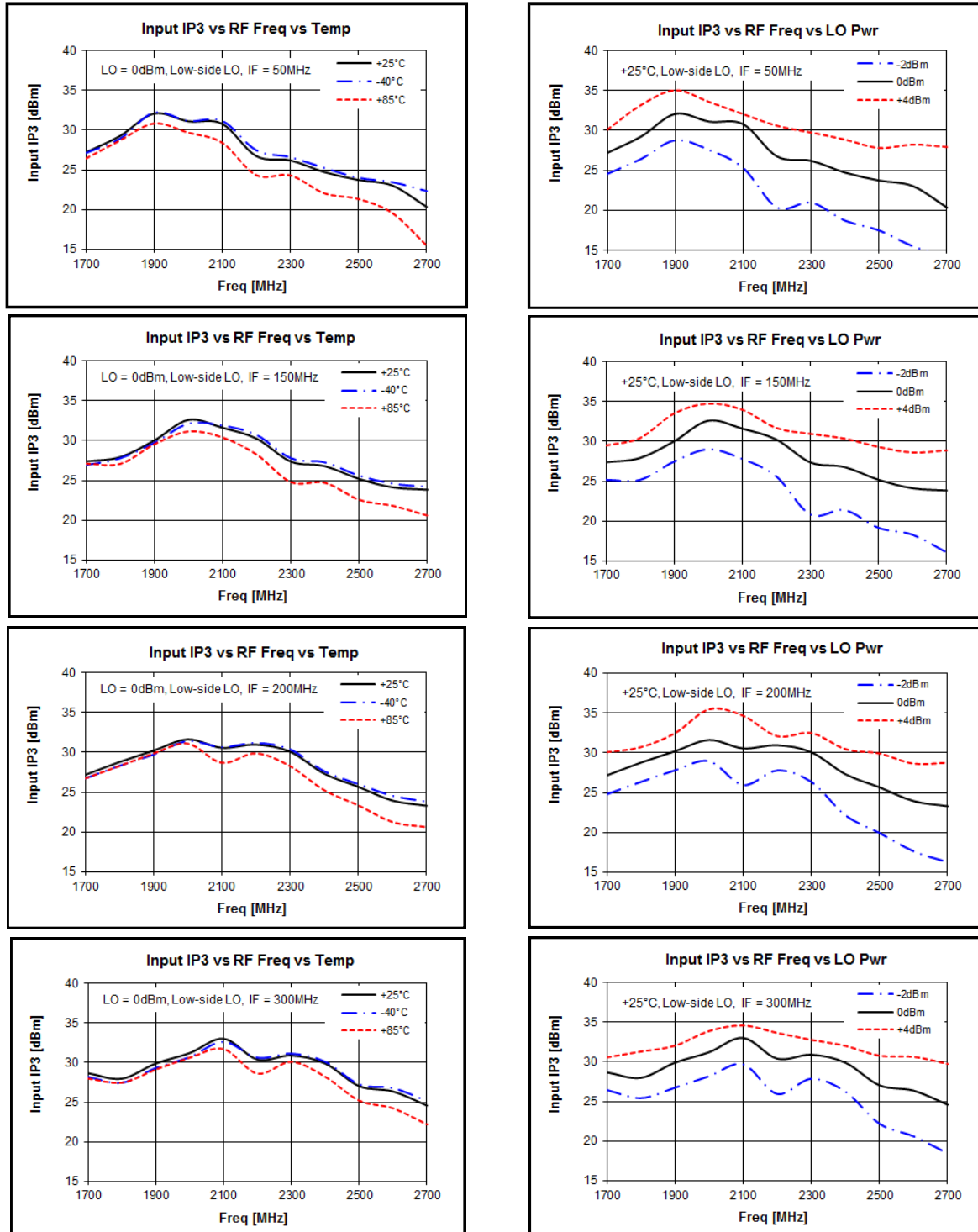

Typical Test Data

Test condition _ Measured on BeRex E/B at 25°C, 50ohm system, Vdd=5V, Ids=57.5mA , Up converting

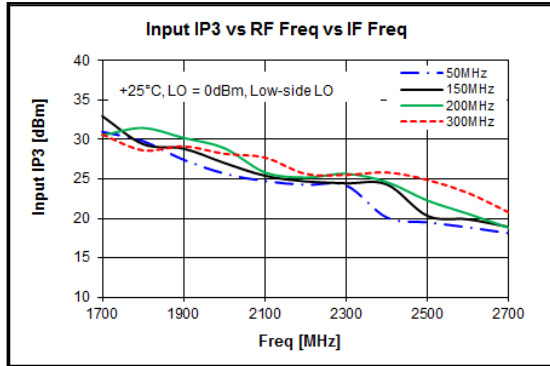

Test condition _ Measured on BeRex E/B at 25°C, 50ohm system, Vdd=3.3V, Ids=44.5mA, Up converting

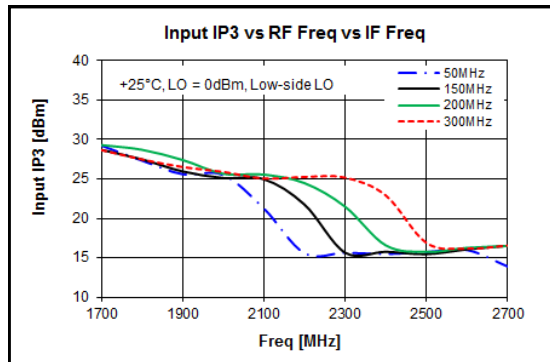

Spur Table

		M					
		0	1	2	3	4	5
N	0		4	13	9	3	8
	1	13	0	24	25	24	20
	2	73	65	44	67	55	55
	3	73	90	76	84	67	75
	4	108	88	105	93	90	88
	5	102	94	91	102	100	94

Spur table is $N \times f_{RF} - M \times f_{LO}$ mixer spurious products for 0 dBm input power, unless otherwise noted.

RF Frequency = 1842 MHz

LO Frequency = 1642 MHz

All values in dBc relative to the IF Power Level.

Package Outline Drawing

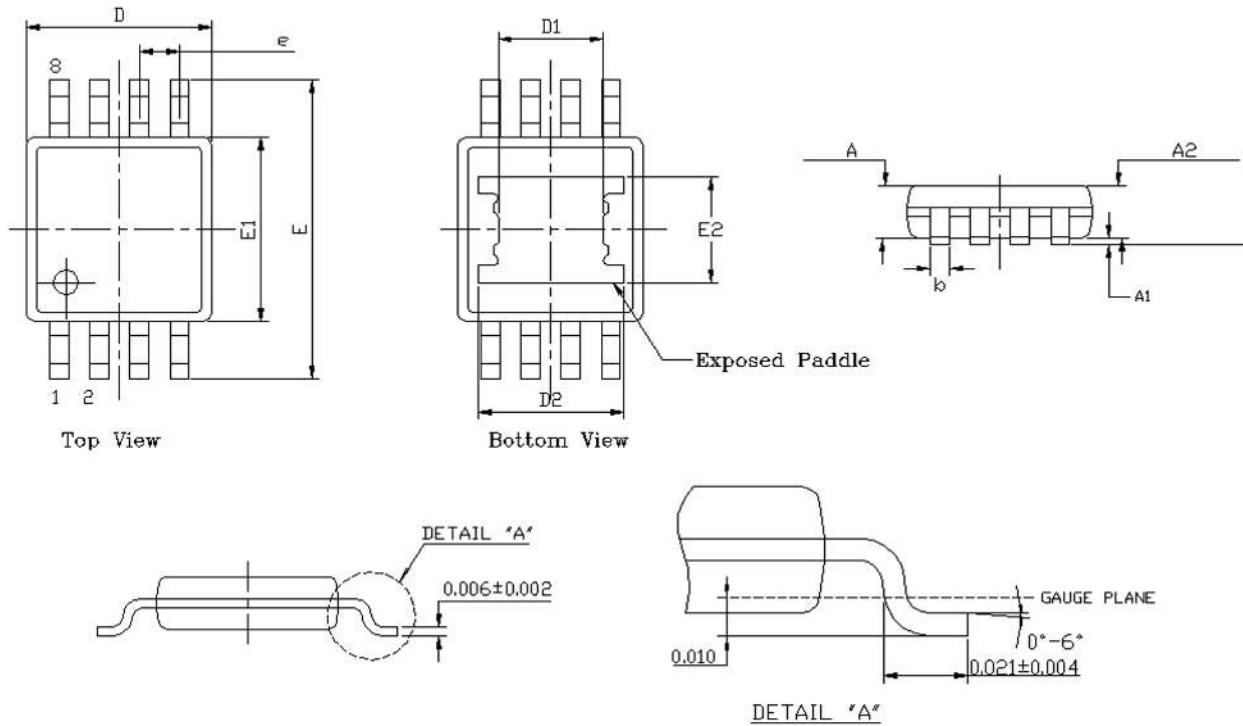

	A	A1	A2	b	D1	D2	D	E	E1	E2	e
MIN.	-	0.002	0.032	0.009	0.067	0.093	0.114	0.188	0.114	0.068 REF.	0.026 TYP.
NOM.	0.037	0.003	0.034	-	REF.	REF.	0.118	0.192	0.118		
MAX.	-	0.005	0.036	0.014			0.122	0.196	0.122		

※Remark all unit in inches

Package Marking



Y = Year, WW = Working Week,
XX = Wafer No.

Evaluation Board Drawing

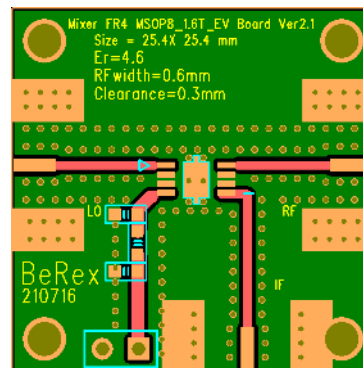

Suggested PCB Land Pattern and SMT Mask Layout

PCB Land Pattern

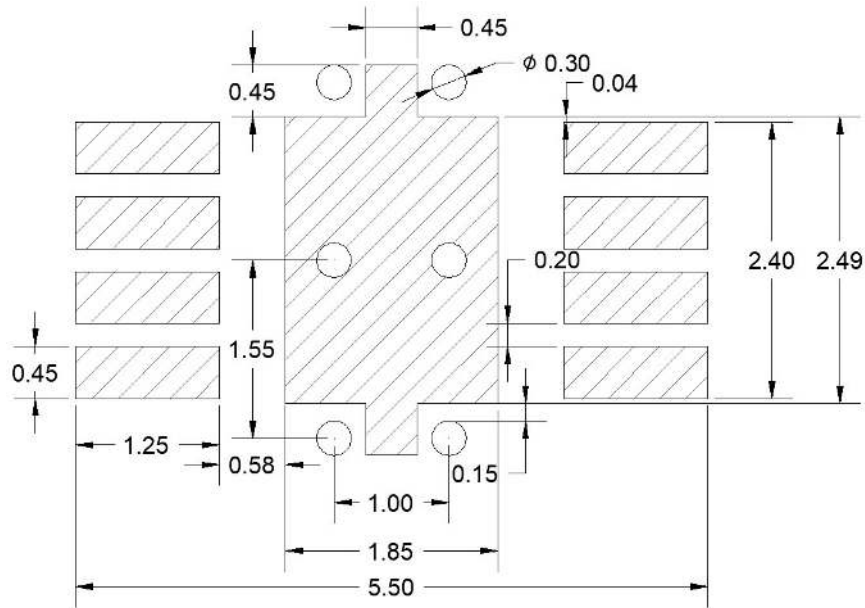

SMT Mask layout

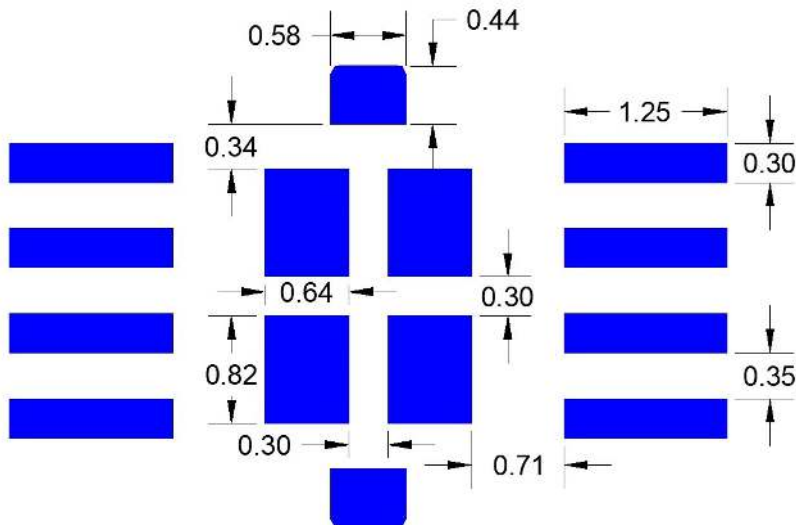

Note : 1. Connection to Bottom Ground with multiple via holes.

2. All Dimensions _ millimeters.

3. PCB lay out _ on BeRex website.

4. Use over 0.10mm-thick (0.10T) metal mask to avoid incomplete soldering on exposed ground pad.

Pin Configuration

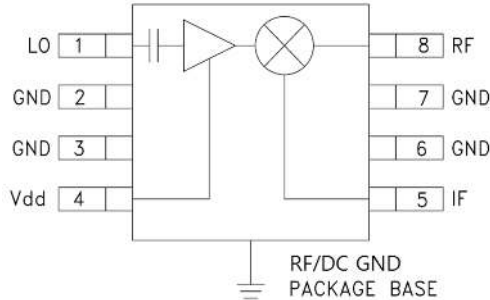

Pin No.	Label	Description
1	LO	Local Oscillator Injection. Internally DC Blocked
2,3,6,7	GND	RF/DC Ground.
4	Vdd	Power supply for LO amplifier
5	IF	Intermediate Frequency
8	RF	Radio Frequency
Backside Paddle	GND	RF/DC Ground. Follow recommended via pattern and ensure good solder attach for best thermal and electrical performance.

Tape & Reel

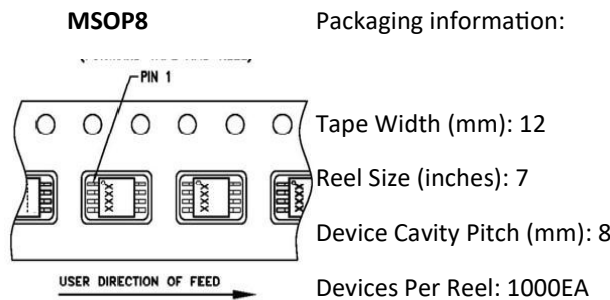

Lead plating finish

100% Tin Matte finish

(All BeRex products undergoes a 1 hour, 150 degree C, Anneal bake to eliminate thin whisker growth concerns.)

MSL / ESD Rating

ESD Rating:	Class 1B
Value:	Passes <1000V
Test:	Human Body Model (HBM)
Standard:	JEDEC Standard JS-001-2014
MSL Rating:	Level 1 at +260°C convection reflow



Proper ESD procedures should be followed when handling this device.

RoHS Compliance

This part is compliant with Restrictions on the Use of Certain Hazardous Substances in Electrical and Electronic Equipment (RoHS) Directive 2011/65/EU as amended by Directive 2015/863/EU.

This product also is compliant with a concentration of the Substances of Very High Concern (SVHC) candidate list which are contained in a quantity of less than 0.1%(w/w) in each components of a product and/or its packaging placed on the European Community market by the BeRex and Suppliers.

NATO CAGE code:

2	N	9	6	F
---	---	---	---	---