

SCM5B49

Voltage Output Modules



Description

Each SCM5B49 voltage output module provides a single channel of analog output. The track-and-hold circuit in the input stage can be operated in a hold mode where one DAC can supply many output modules, or a track mode where one DAC is dedicated to each module. In addition to the track-and-hold circuit, each module provides signal buffering, isolation, filtering, and conversion to a high-level voltage output (Figure 1).

Setting of the track or hold mode is controlled by the logic state of WR EN\, module pin 23. When pin 23 is low, the track mode is enabled. If pin 23 is high, the hold mode is enabled. The module is designed with a completely isolated computer side circuit which can be floated to $\pm 50V$ from Power Common, pin 16. This complete isolation means that no connection is required between I/O Common and Power Common for proper operation of the track and hold circuit. For a low state, simply connect pin 23, the Write-Enable pin, to I/O Common, pin 19.

The SCMPB02 and SCMPB06 backpanels allow host computer control of the WR EN\ control line, which allows multiplexing of one host DAC to up to 64 SCM5B49 output modules.

Features

- Accepts High-Level Voltage Inputs to $\pm 10V$
- Provides High-Level Voltage Outputs to $\pm 10V$
- 1500 Vrms Transformer Isolation
- ANSI/IEEE C37.90.1 Transient Protection
- 5 Poles of Filtering
- 110dB CMR
- 400Hz Signal Bandwidth
- $\pm 0.03\%$ Accuracy
- $\pm 0.015\%$ Linearity
- CSA C/US Certified
- CE and ATEX Compliant
- Mix and Match SCM5B Types on Backpanel

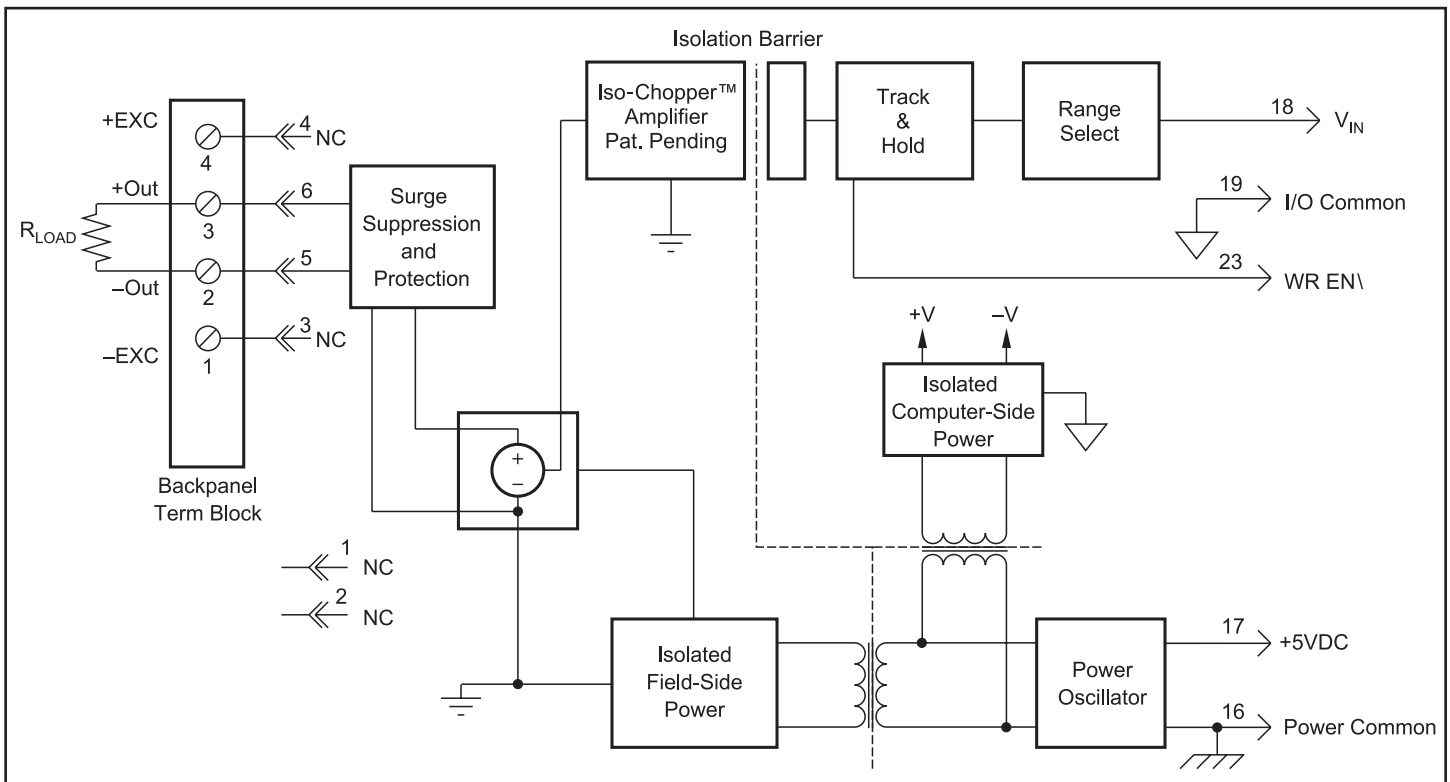

Figure 1: SCM5B49 Block Diagram

Specifications Typical* at $T_A = +25^\circ\text{C}$ and +5VDC power

Module	SCM5B49
Input Voltage Range	$\pm 5\text{V}$, 0 to +5V, $\pm 10\text{V}$, 0 to +10V
Input Voltage Maximum	$\pm 36\text{V}$ (no damage)
Input Resistance	50M Ω
Output Voltage Range	$\pm 5\text{V}$, 0 to +5V, $\pm 10\text{V}$, 0 to +10V
Over Range Capability	5% at 10V output
Output Drive	50mA max
Output Resistance	0.5 Ω
Output I Under Fault, Max	75mA
Output Protection	
Continuous	240Vrms max
Transient	ANSI/IEEE C37.90.1
CMV, Output to Input	
Continuous	1500Vrms max
Transient	ANSI/IEEE C37.90.1
CMR (50 or 60Hz)	110dB
NMR (-3dB at 400Hz)	80dB per Decade above 400Hz
Accuracy ⁽¹⁾	$\pm 0.03\%$ Span (0-5mA Load)
Linearity	$\pm 0.015\%$ Span
Stability	
Zero	$\pm 25\text{ppm}/^\circ\text{C}$
Span	$\pm 20\text{ppm}/^\circ\text{C}$
Noise	
Output Ripple, 100kHz bandwidth	2mVp-p
Bandwidth, -3dB	400Hz
Response Time, 90% Span	1.25ms
Sample and Hold	
Output Droop Rate	0.2% Span/s
Acquisition Time	50 μs
Track-and-Hold Enable Control	
Max Logic "0"	+0.8V
Min Logic "1"	+2.4V
Max Logic "1"	+36V
Input Current "0"	0.5 μA
Power Supply Voltage	+5VDC $\pm 5\%$
Power Supply Current	350mA Full Load, 135mA no load
Power Supply Sensitivity	$\pm 12.5\text{ppm}/\%$
Mechanical Dimensions (h)(w)(d)	2.28" x 2.26" x 0.60" (58mm x 57mm x 15mm)
Environmental	
Operating Temperature Range	-40 $^\circ\text{C}$ to +85 $^\circ\text{C}$
Storage Temperature Range	-40 $^\circ\text{C}$ to +85 $^\circ\text{C}$
Relative Humidity	0 to 95% Noncondensing
Emissions EN61000-6-4	ISM, Group 1
Radiated, Conducted	Class A
Immunity EN61000-6-2	ISM, Group 1
RF	Performance A $\pm 0.5\%$ Span Error
ESD, EFT	Performance B

NOTES:

*Contact factory or your local Dataforth sales office for maximum values.

(1) Includes linearity, hysteresis and repeatability.

Ordering Information

Model	Input Range	Output Range
SCM5B49-01	0V to +5V	-5V to +5V
SCM5B49-02	-5V to +5V	-5V to +5V
SCM5B49-03	-5V to +5V	0V to +5V
SCM5B49-04	0V to +10V	-10V to +10V
SCM5B49-05	-10V to +10V	-10V to +10V
SCM5B49-06	-10V to +10V	0V to +10V
SCM5B49-07	-5V to +5V	-10V to +10V