

Industrial relay modules and solid-state relays

Industrial relay modules and solid-state relays	Industrial relay modules and solid-state relays - Overview	B.2
	RIDERSERIES - Overview	B.4
	RIDERSERIES - Relay modules	B.6
	RIDERSERIES FG - Overview	B.44
	RIDERSERIES FG - Relay modules	B.46
	RS-SERIES - Relay modules	B.48
	RSO-SERIES - Solid-state relays	B.58

Industrial relay module and solid-state relay with the proven connection technology

Easy handling and safe connections

Weidmüller's relay bases are remarkable for their secure connection systems and their ease of use during wiring and installation. Pluggable cross-connection and the extra-quick PUSH IN connection help you to further reduce wiring times. In combination with the established relay technology, Weidmüller's industrial relays and solid state relays provide users with excellent reliability and service convenience. Whether electro-mechanical or electronic, our extensive choice of relay modules and solid-state relays provides the proper solution for all of your industrial application needs.





Coupling modules - the industrial standard



Relay module with 1 to 4 CO contacts

The RIDER SERIES and its RCI, RCM, RRD and RPW product lines have been successfully integrated into the entire Weidmüller line of relay products. This modular-designed product series formally complies with international standards. A variety of pluggable versions are available with from one to four CO contacts and your choice of connection method.

Our innovative relay bases with PUSH IN connection systems are available for both the RCI/RCL and RCM product lines. PUSH IN technology is safe and easy to use and it allows you to reduce costs with less wiring time. The relay modules are designed for industrial applications and feature sturdy relay pins and industrial-standard pinning. A mechanically operated, stay-down test button is integrated into the design. It enables switching statuses to be simulated during initial commissioning. Additional product features include LED status indicators and free-wheel diodes (DC).

Our relay kits are particularly convenient to use. They include the relay module with status display and the base with ejection lever.

The kits are delivered fully assembled and with completely tested functionality. This saves time during assembly and reduces the number of products required.

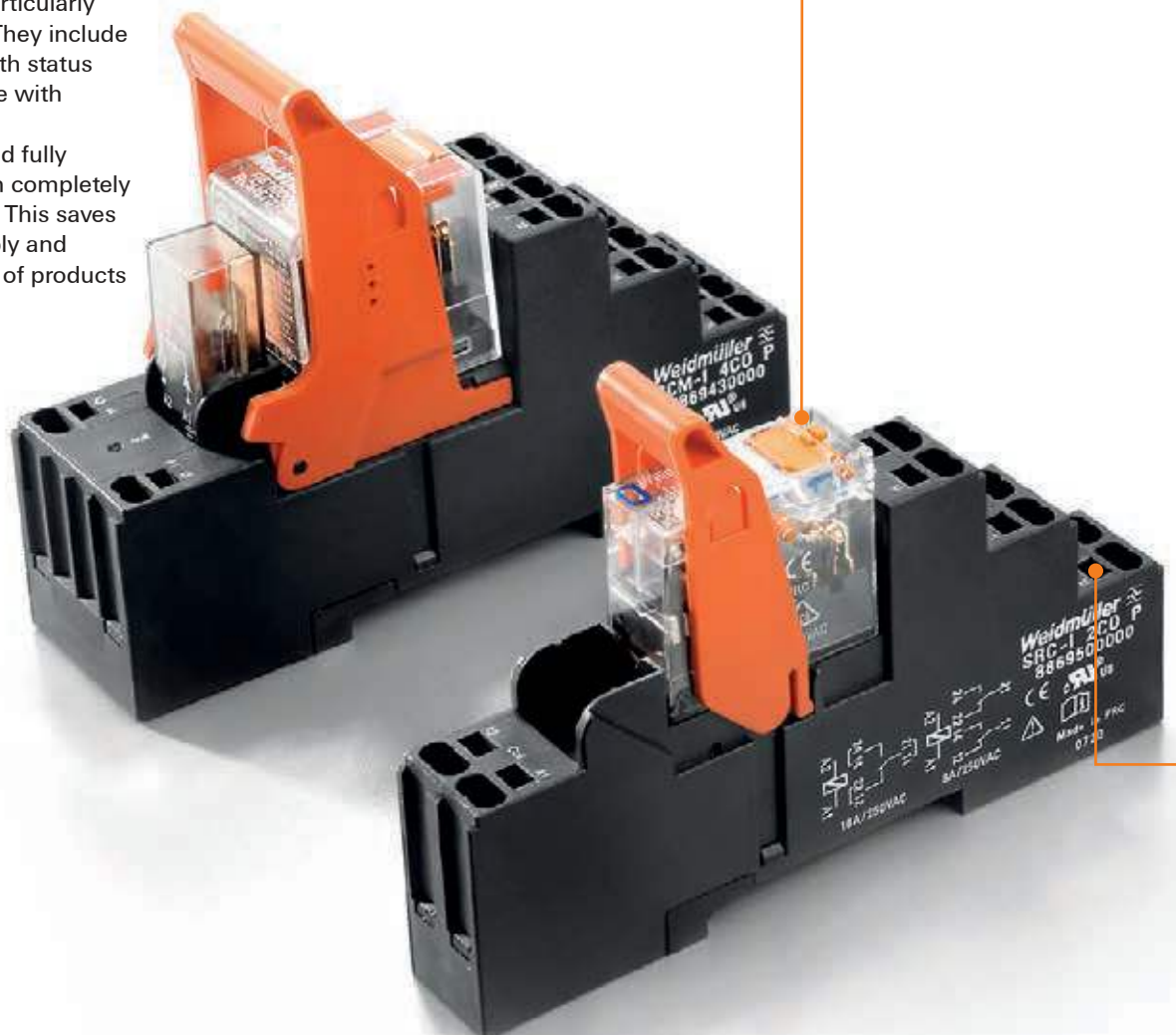

Simple

The stay-down test button simplifies commissioning and service work



Customised

Suppressor circuitry and LED can be integrated into a relay module or as a pluggable module at the base

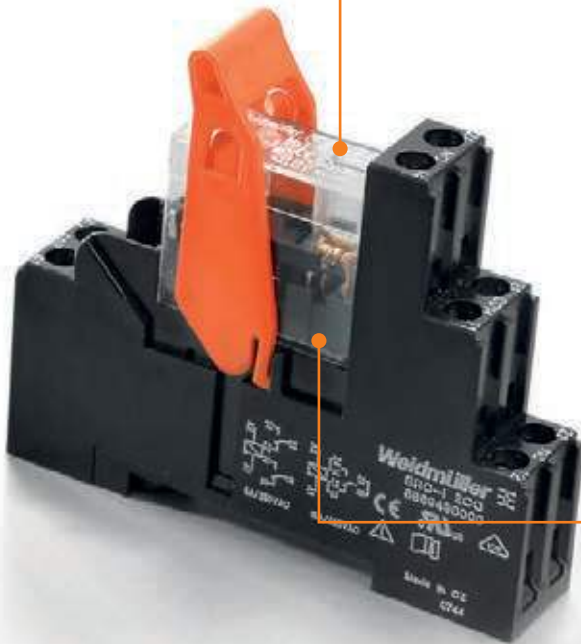

Safe

The heavy-duty industrial pins ensure a reliable connection



Saves time

No-screw PUSH IN connections and cross-connections can reduce wiring time by more than 50 %

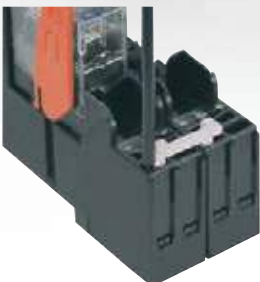

RCI KIT with screw connection

1 CO

- 4000 VA switching capacity
- Stable plug-in connections
- LED (AC red / DC green) integrated in relay
- Protective suppressor circuit for DC coil
- Optional test button with latching function and inspection window
- Identification of coils (AC red / DC blue)



Technical data

Output	
Rated switching voltage	240 V AC
Max. switching voltage, AC	400 V
Continuous current	16 A ¹⁾
Contact material	AgNi 90/10
Mechanical service life	AC coil 5 x 10 ⁶ switch. ops, DC coil 10 x 10 ⁶ switch. cycles
Sparkover time / Drop-out time	8 ms / 6 ms
Rated data	
Status indicator [print] / Free-wheel diode	Green LED = DC coil; red LED = AC coil / Yes
Ambient temperature (operational)	-40 °C...+70 °C
Flammability class UL94	V-0
Humidity	40 °C / 93 % rel. humidity, no condensation
Approvals	CE; GL
Insulation coordination (EN 50 178)	
Rated voltage	250 V
Clearance and creepage distances for control side - load side	> 8 mm
Surge voltage category	III
Pollution severity	3

Dimensions	Screw connection
Clamping range (nominal / min. / max.)	mm ² 2.5 / 0.5 / 2.5
Length x width x height	mm 70 / 15.5 / 77
Note	1) The relay connections 11 - 21, 12 - 22 and 14 - 24 must be bridged when using the full continuous current (16 A).

DC-Version

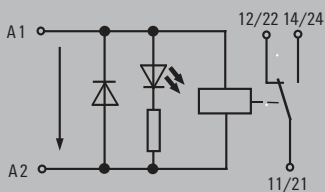

AC-Version

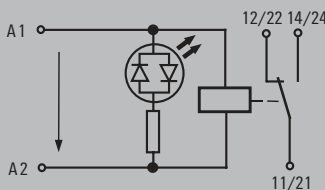

Ordering data

Input	24 V DC 1CO	24 V AC 1CO	115 V AC 1CO	230 V AC 1CO
Rated control voltage	24 V DC	24 V AC	115 V AC	230 V AC
Rated current AC		31.6 mA	7 mA	3.5 mA
Rated current DC	16.7 mA			
Power rating	420 mW	0.75 VA	0.8 VA	0.8 VA
AC Response/dropout Volt		18 V / 3.6 V	86.3 V / 17.3 V	172.5 V / 34.5 V
DC Response/dropout Volt	16.8 V / 2.4 V			
Coil resistance	1440 Ω ±10 %	350 Ω ±10 %	8100 Ω ±15 %	32500 Ω ±15 %

Ordering data	24 V DC 1CO		24 V AC 1CO		115 V AC 1CO		230 V AC 1CO	
Relay with socket								
w. test button	Type	RCIKIT 24VDC 1CO LD/PB	Type	RCIKIT 24VAC 1CO LD/PB	Type	RCIKIT 115VAC 1CO LD/PB	Type	RCIKIT 230VAC 1CO LD/PB
	Order No.	8881580000	Order No.	8881590000	Order No.	8897060000	Order No.	8881600000
w.o. test button	Type	RCIKIT 24VDC 1CO LED	Type	RCIKIT 24VAC 1CO LED	Type	RCIKIT 115VAC 1CO LD	Type	RCIKIT 230VAC 1CO LED
	Order No.	8871000000	Order No.	8871010000	Order No.	8897090000	Order No.	8871020000

Ordering data	24 V DC 1CO		24 V AC 1CO		115 V AC 1CO		230 V AC 1CO	
Spare relay								
w. test button	Type	RCI374AC4	Type	RCI374R24	Type	RCI374S15	Type	RCI374T30
	Order No.	8870250000		Order No.	8870280000		Order No.	8870300000
w.o. test button	Type	RCI314AC4	Type	RCI314R24	Type	RCI314S15	Type	RCI314T30
	Order No.	8870100000		Order No.	8870130000		Order No.	8870150000

Note	24 V DC 1CO		24 V AC 1CO		115 V AC 1CO		230 V AC 1CO	

RCI-KITP with PUSH IN connection

1 CO

- 4000 VA switching capacity
- Stable plug-in connections
- LED (AC red / DC green) integrated in relay
- Protective suppressor circuit for DC coil
- Optional test button with latching function and inspection window
- Identification of coils (AC red / DC blue)



DC-Version

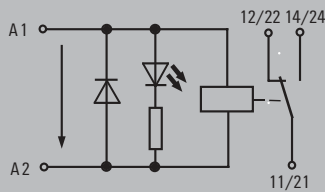

AC-Version

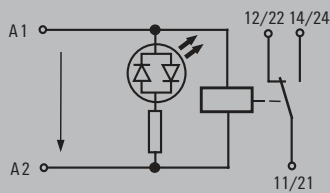

Technical data

Output	
Rated switching voltage	240 V AC
Max. switching voltage, AC	400 V
Continuous current	16 A ¹⁾
Contact material	AgNi 90/10
Mechanical service life	AC coil 5 x 10 ⁶ switch. ops, DC coil 10 x 10 ⁶ switch. cycles
Sparkover time / Drop-out time	8 ms / 6 ms
Rated data	
Status indicator [print] / Free-wheel diode	Green LED = DC coil; red LED = AC coil / Yes
Ambient temperature (operational)	-40 °C...+70 °C
Flammability class UL94	V-0
Humidity	40 °C / 93 % rel. humidity, no condensation
Approvals	CE; GL
Insulation coordination (EN 50 178)	
Rated voltage	250 V
Clearance and creepage distances for control side - load side	> 8 mm
Surge voltage category	III
Pollution severity	3

Dimensions	PUSH IN spring connection	
Clamping range (nominal / min. / max.)	mm ²	1.5 / 0.5 / 1.5
Length x width x height	mm	70 / 15.5 / 98
Note	1) The relay connections 11 - 21, 12 - 22 and 14 - 24 must be bridged when using the full continuous current (16 A).	

Ordering data

Input	24 V DC 1CO	24 V AC 1CO	115 V AC 1CO	230 V AC 1CO
Rated control voltage	24 V DC	24 V AC	115 V AC	230 V AC
Rated current AC		31.6 mA	7 mA	3.5 mA
Rated current DC	16.7 mA			
Power rating	420 mW	0.75 VA	0.8 VA	0.8 VA
AC Response/dropout Volt		18 V / 3.6 V	86.3 V / 17.3 V	172.5 V / 34.5 V
DC Response/dropout Volt	16.8 V / 2.4 V			
Coil resistance	1440 Ω ±10 %	350 Ω ±10 %	8100 Ω ±15 %	32500 Ω ±15 %

Ordering data		24 V DC 1CO		24 V AC 1CO		115 V AC 1CO		230 V AC 1CO	
Relay with socket									
w. test button	Type	RCIKITP 24VDC 1CO LD/PB		RCIKITP 24VAC 1CO LD/PB		RCIKITP115VAC 1CO LD/PB		RCIKITP230VAC 1CO LD/PB	
	Order No.	8897190000		8897200000		8897210000		8897220000	
w.o. test button	Type	RCIKITP 24VDC 1CO LD		RCIKITP 24VAC 1CO LD		RCIKITP 115VAC 1CO LD		RCIKITP 230VAC 1CO LD	
	Order No.	8897110000		8897120000		8897130000		8897140000	
Ordering data		w. test button		w.o. test button		w. test button		w.o. test button	
Spare relay									
	Type	RCI374AC4		RCI314AC4		RCI374R24		RCI314R24	
	Order No.	8870250000		8870100000		8870280000		8870130000	
	Type	RCI374S15		RCI314S15		RCI374S15		RCI314S15	
	Order No.	8870290000		8870140000		8870300000		8870150000	
Note									

Accessories for RCI KIT relay modules, 1 CO

Plug-in module with PUSH IN connection

Plug-in module with screw connection



Technical data

Rated current	2 x 12 A*
Rated voltage	240 V AC
Dielectric strength of coil contacts	4000 V _{eff}
Ambient temperature (operational)	-25 °C...+85 °C
Protection class (IEC 61810)	IP20
Approvals	VDE, cURus, CSA
Connection cross-section	
- Solid-core wire	2 x 1.5 mm ²
- Stranded wire	2 x 1.5 mm ²
- with ferrule	2 x 1.0 mm ²
Rated torque acc. to IEC 61984 for screw connection	

Rated current	2 x 12 A*
Rated voltage	240 V AC
Dielectric strength of coil contacts	> 3000 V _{eff}
Ambient temperature (operational)	-25 °C...+85 °C
Protection class (IEC 61810)	IP20
Approvals	VDE, cURus, CSA
Connection cross-section	
- Solid-core wire	2 x 2.5 mm ²
- Stranded wire	2 x 2.5 mm ²
- with ferrule	2 x 1.5 mm ²
Rated torque acc. to IEC 61984 for screw connection	0.5 Nm / max. 0.7 Nm

Rated current	2 x 12 A*
Rated voltage	240 V AC
Dielectric strength of coil contacts	> 3000 V _{eff}
Ambient temperature (operational)	-25 °C...+85 °C
Protection class (IEC 61810)	IP20
Approvals	VDE, cURus, CSA
Connection cross-section	
- Solid-core wire	2 x 2.5 mm ²
- Stranded wire	2 x 2.5 mm ²
- with ferrule	2 x 1.5 mm ²
Rated torque acc. to IEC 61984 for screw connection	0.5 Nm / max. 0.7 Nm

*) For 1-pole relay modules (16 A), the following terminals must be connected: 11 with 21, 12 with 22, and 14 with 24.



Ordering data

Description
Plug-in module, snaps onto TS35 DIN mounting rail, 2-pole

Type	Qty.	Order No.
SRC-I 2CO P	10	8869500000

Type	Qty.	Order No.
SRC-I 2CO	10	8869490000

Accessories

Description
Plastic retaining clip
Metal retaining clip
Label
MultiCard 6x15 mm
 Cross-connector for PUSH IN base, 2-pole, 12 A
 Cross-connector for screw base, 8-pole

Type	Qty.	Order No.
SRC-I CLIP HP	10	8869510000
SRC-I CLIP HM RCI	20	1132090000
SRC-I MARK	10	8869530000
ESG 6/15 K MC NEUTR. WS	200	1880100000
SRC-I QV	10	8870840000

Type	Qty.	Order No.
SRC-I CLIP HP	10	8869510000
SRC-I CLIP HM RCI	20	1132090000
SRC-I MARK	10	8869530000
ESG 6/15 K MC NEUTR. WS	200	1880100000
SRC-I QV S		1132070000

Dimensions

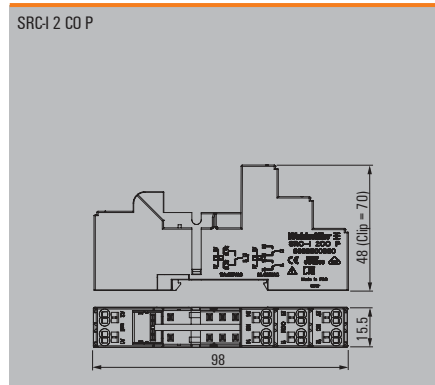

Dimensions

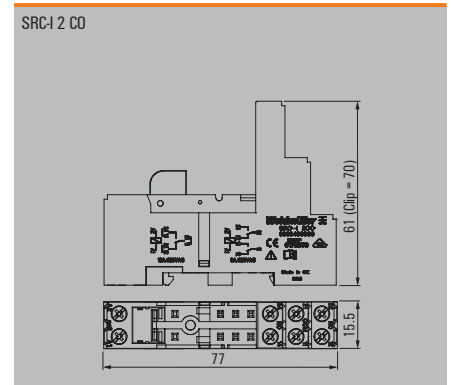

Dimensions in mm

LED and protective modules for the SRC-I plug-in frame

Simply plug into the base module; reverse-connect protection. Connect parallel to coil.

Ordering data

Description
Free Wheel diode 1N4007
Resistor 100 kΩ 1 Watt
RC-element 6 ... 60 V AC; 470 Ω / 220 nF
RC-element 110 ... 230 V AC; 4.7 Ω / 10 nF
Varistor protection 24 V; S07K30
Varistor protection 110 V; S07K130
Varistor protection 230 V; S07K275
LED
LED 6 ... 24 V DC with free wheel diode
LED 24 ... 60 V DC with free wheel diode
LED 110 ... 230 V DC with free wheel diode
LED 6 ... 24 V DC / V AC
LED 24 ... 60 V DC / V AC
LED 110 ... 230 V DC / V AC

Type	Qty.	Order No.	Order No.
RIM-I 1 6/230V	10	8869580000	
RIM-I 1 R 110/230V	10	8870830000	
RIM-I 3 6/60VAC	10	8869770000	
RIM-I 3 110/230VAC	10	8869790000	
RIM-I 4 24VUC	10	8869710000	
RIM-I 4 110VUC	10	8869730000	
RIM-I 4 230VUC	10	8869750000	
		red	green
RIM-I 2 6/24VDC	10	8869590000	8869600000
RIM-I 2 24/60VDC	10	8869670000	8869680000
RIM-I 2 110/230VDC	10	8869690000	8869700000
RIM-I 3 6/24VUC	10	8869630000	8869640000
RIM-I 3 24/60VUC	10	8869610000	8869620000
RIM-I 3 110/230VUC	10	8869650000	8869660000

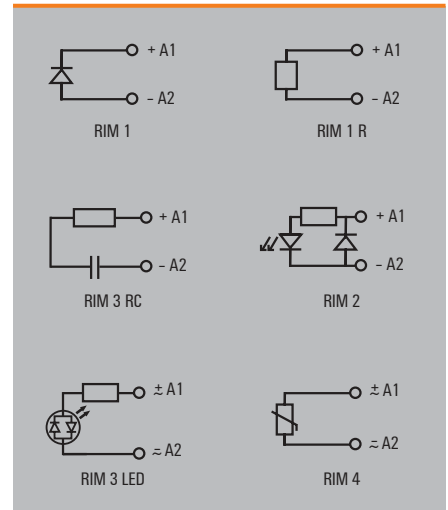
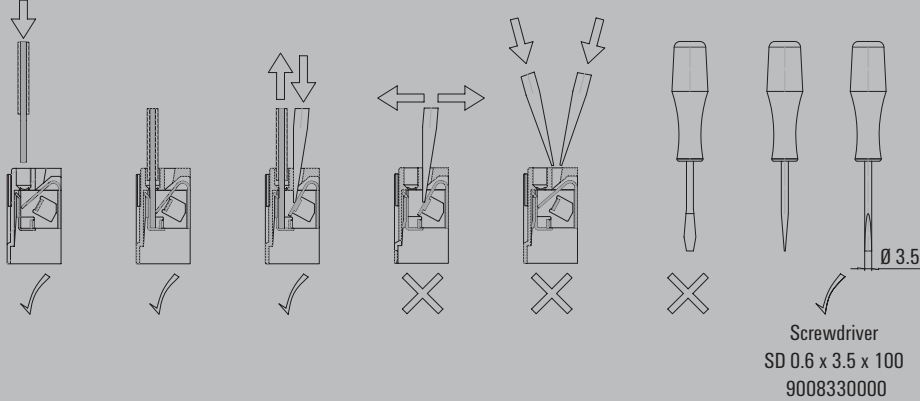
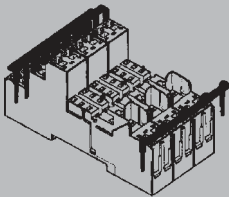
**Warnings and notes on usage****Handling the PUSH IN connection****Cross-connector mounting for PUSH IN base**

If more than two poles need to be connected with stacked cross-connector ridges, then the lower ridge must be stripped and shortened to the proper length so it will fit.

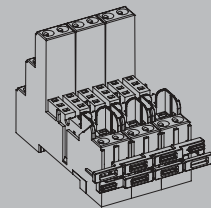
Cross-connector mounting for screw base

RCI KIT with screw connection

2 CO

- 2000 VA switching capacity
- Stable plug-in connections
- LED (AC red / DC green) integrated in relay
- Protective suppressor circuit for DC coil
- Optional test button with latching function and inspection window
- Identification of coils (AC red / DC blue)



Technical data

Output	
Rated switching voltage	240 V AC
Max. switching voltage, AC	400 V
Continuous current	8 A
Contact material	AgNi 90/10
Mechanical service life	AC coil 5 x 10 ⁶ switch. ops, DC coil 10 x 10 ⁶ switch. cycles
Sparkover time / Drop-out time	10 ms / 4 ms
Rated data	
Status indicator [print] / Free-wheel diode	Green LED = DC coil; red LED = AC coil / Yes
Ambient temperature (operational)	-40 °C...+70 °C
Flammability class UL94	V-0
Humidity	40 °C / 93 % rel. humidity, no condensation
Approvals	CE; GL
Insulation coordination (EN 50 178)	
Rated voltage	250 V
Clearance and creepage distances for control side - load side	> 8 mm
Surge voltage category	III
Pollution severity	2

Dimensions	Screw connection
Clamping range (nominal / min. / max.)	mm ² 2.5 / 0.5 / 2.5
Length x width x height	mm 70 / 15.5 / 77
Note	

DC-Version

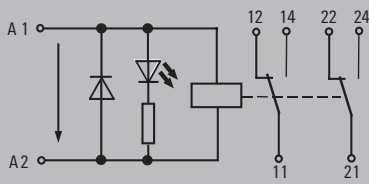

AC-Version

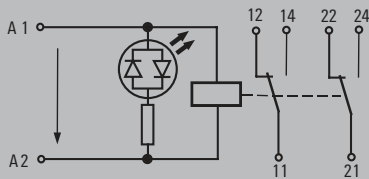

Ordering data

Input	24 V DC 2CO	24 V AC 2CO	115 V AC 2CO	230 V AC 2CO
Rated control voltage	24 V DC	24 V AC	115 V AC	230 V AC
Rated current AC		31.6 mA	7 mA	3.5 mA
Rated current DC	16.7 mA			
Power rating	420 mW	0.75 VA	0.8 VA	0.8 VA
AC Response/dropout Volt		18 V / 3.6 V	86.3 V / 17.3 V	172.5 V / 34.5 V
DC Response/dropout Volt	16.8 V / 2.4 V			
Coil resistance	1440 Ω ±10 %	350 Ω ±10 %	8100 Ω ±15 %	32500 Ω ±15 %

Ordering data		24 V DC 2CO	24 V AC 2CO	115 V AC 2CO	230 V AC 2CO
Relay with socket					
w. test button	Type	RCIKIT 24VDC 2CO LD/PB	RCIKIT 24VAC 2CO LD/PB	RCIKIT 115VAC 2CO LD/PB	RCIKIT 230VAC 2CO LD/PB
	Order No.	8881610000	8881620000	8897080000	8881630000
w.o. test button	Type	RCIKIT 24VDC 2CO LED	RCIKIT 24VAC 2CO LED	RCIKIT 115VAC 2CO LD	RCIKIT 230VAC 2CO LED
	Order No.	8871030000	8871040000	8897100000	8871050000

Ordering data		24 V DC 2CO	24 V AC 2CO	115 V AC 2CO	230 V AC 2CO
Spare relay					
	Type	w. test button RCI484AC4	w. test button RCI484R24	w. test button RCI484S15	w. test button RCI484T30
	Order No.	8870320000	8870350000	8870360000	8870370000
		w.o. test button RCI424AC4	w.o. test button RCI424R24	w.o. test button RCI424S15	w.o. test button RCI424T30
		8870180000	8870210000	8870220000	8870230000

Note	

RCI-KITP with PUSH IN connection

2 CO

- 2000 VA switching capacity
- Stable plug-in connections
- LED (AC red / DC green) integrated in relay
- Protective suppressor circuit for DC coil
- Optional test button with latching function and inspection window
- Identification of coils (AC red / DC blue)



DC-Version

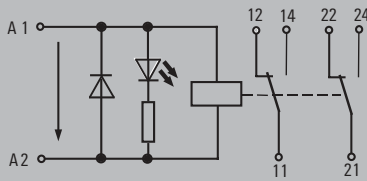

AC-Version

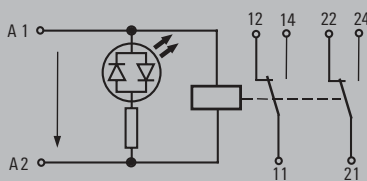

Technical data

Output	
Rated switching voltage	240 V AC
Max. switching voltage, AC	400 V
Continuous current	8 A
Contact material	AgNi 90/10
Mechanical service life	AC coil 5 x 10 ⁶ switch. ops, DC coil 10 x 10 ⁶ switch. cycles
Sparkover time / Drop-out time	10 ms / 4 ms
Rated data	
Status indicator [print] / Free-wheel diode	Green LED = DC coil; red LED = AC coil / Yes
Ambient temperature (operational)	-40 °C...+70 °C
Flammability class UL94	V-0
Humidity	40 °C / 93 % rel. humidity, no condensation
Approvals	CE; GL
Insulation coordination (EN 50 178)	
Rated voltage	250 V
Clearance and creepage distances for control side - load side	> 8 mm
Surge voltage category	III
Pollution severity	2

Dimensions	PUSH IN spring connection	
Clamping range (nominal / min. / max.)	mm ²	1.5 / 0.5 / 1.5
Length x width x height	mm	70 / 15.5 / 98
Note		

Ordering data

Input	24 V DC 2CO	24 V AC 2CO	115 V AC 2CO	230 V AC 2CO
Rated control voltage	24 V DC	24 V AC	115 V AC	230 V AC
Rated current AC		31.6 mA	7 mA	3.5 mA
Rated current DC	16.7 mA			
Power rating	420 mW	0.75 VA	0.8 VA	0.8 VA
AC Response/dropout Volt		18 V / 3.6 V	86.3 V / 17.3 V	172.5 V / 34.5 V
DC Response/dropout Volt	16.8 V / 2.4 V			
Coil resistance	1440 Ω ±10 %	350 Ω ±10 %	8100 Ω ±15 %	32500 Ω ±15 %

Ordering data		24 V DC 2CO		24 V AC 2CO		115 V AC 2CO		230 V AC 2CO	
Relay with socket									
w. test button	Type	RCIKITP 24VDC 2CO LD/PB		RCIKITP 24VAC 2CO LD/PB		RCIKITP115VAC 2CO LD/PB		RCIKITP230VAC 2CO LD/PB	
	Order No.	8897230000		8897240000		8897250000		8897260000	
w.o. test button	Type	RCIKITP 24VDC 2CO LD		RCIKITP 24VAC 2CO LD		RCIKITP 115VAC 2CO LD		RCIKITP 230VAC 2CO LD	
	Order No.	8897150000		8897160000		8897170000		8897180000	

Ordering data		24 V DC 2CO		24 V AC 2CO		115 V AC 2CO		230 V AC 2CO	
Spare relay		w. test button	w.o. test button	w. test button	w.o. test button	w. test button	w.o. test button	w. test button	w.o. test button
	Type	RCI484AC4	RCI424AC4	RCI484R24	RCI424R24	RCI484S15	RCI424S15	RCI484T30	RCI424T30
	Order No.	8870320000	8870180000	8870350000	8870210000	8870360000	8870220000	8870370000	8870230000

Note	

Accessories for RCI KIT relay modules, 2 CO

Plug-in module with PUSH IN connection

Plug-in module with screw connection

Plug-in module with screw connection

Standard height

Low height

PUSH IN



Technical data

Rated current	2 x 12 A
Rated voltage	240 V AC
Dielectric strength of coil contacts	4000 V _{eff}
Ambient temperature (operational)	-25 °C...+85 °C
Protection class (IEC 61810)	IP20
Stripping length	12 mm
Approvals	VDE, cURus, CSA
Connection cross-section	
- Solid-core wire	1 x 1.5 mm ² / 2 x 1.0 mm ²
- Stranded wire	1 x 1.5 mm ² / 2 x 1.0 mm ²
- with ferrule	1 x 1.0 mm ² / 2 x 0.75 mm ²
Rated torque acc. to IEC 61984 for screw connection	

Rated current	2 x 12 A
Rated voltage	240 V AC
Dielectric strength of coil contacts	> 3000 V _{eff}
Ambient temperature (operational)	-25 °C...+85 °C
Protection class	IP20
Stripping length	8 mm
Approvals	VDE, cURus, CSA
Connection cross-section	
- Solid-core wire	2 x 2.5 mm ²
- Stranded wire	2 x 2.5 mm ²
- with ferrule	2 x 1.5 mm ²
Rated torque acc. to IEC 61984 for screw connection	0.5 Nm / max. 0.7 Nm

Rated current	2 x 12 A
Rated voltage	240 V AC
Dielectric strength of coil contacts	> 3000 V _{eff}
Ambient temperature (operational)	-25 °C...+85 °C
Protection class	IP20
Stripping length	8 mm
Approvals	VDE, cURus, CSA
Connection cross-section	
- Solid-core wire	2 x 2.5 mm ²
- Stranded wire	2 x 2.5 mm ²
- with ferrule	2 x 1.5 mm ²
Rated torque acc. to IEC 61984 for screw connection	0.5 Nm / max. 0.7 Nm

Rated current	2 x 12 A
Rated voltage	240 V AC
Dielectric strength of coil contacts	> 3000 V _{eff}
Ambient temperature (operational)	-25 °C...+85 °C
Protection class	IP20
Stripping length	8 mm
Approvals	VDE, cURus, CSA
Connection cross-section	
- Solid-core wire	2 x 2.5 mm ²
- Stranded wire	2 x 2.5 mm ²
- with ferrule	2 x 1.5 mm ²
Rated torque acc. to IEC 61984 for screw connection	0.5 Nm / max. 0.7 Nm

Ordering data

Description
Plug-in module, snaps onto TS35 DIN mounting rail, 2-pole

Type	Qty.	Order No.
SRC-I 2CO P		8869500000

Type	Qty.	Order No.
SRC-I 2CO		8869490000

Type	Qty.	Order No.
SRC-I 2CO N		8869480000

Accessories

Description
Plastic retaining clip
Metal retaining clip
Label
MultiCard 6x15 mm

Type	Qty.	Order No.
SRC-I CLIP HP	10	8869510000
SRC-I CLIP HM RCI	20	1132090000
SRC-I MARK	10	8869530000
ESG 6/15 K MC	200	1880100000
NEUTR. WS		
SRC-I QV P		8870840000

Type	Qty.	Order No.
SRC-I CLIP HP	10	8869510000
SRC-I CLIP HM RCI	20	1132090000
SRC-I MARK	10	8869530000
ESG 6/15 K MC	200	1880100000
NEUTR. WS		

Type	Qty.	Order No.
SRC-I CLIP HP	10	8869510000
SRC-I CLIP HM RCI	20	1132090000
SRC-I MARK	10	8869530000
ESG 6/15 K MC	200	1880100000
NEUTR. WS		



Cross-connector for PUSH IN base, 2-pole, 12 A



Cross-connector for screw base, 8-pole

Dimensions

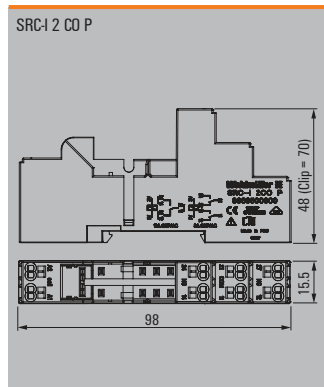

Dimensions

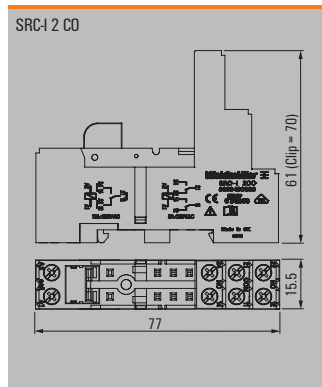

Dimensions

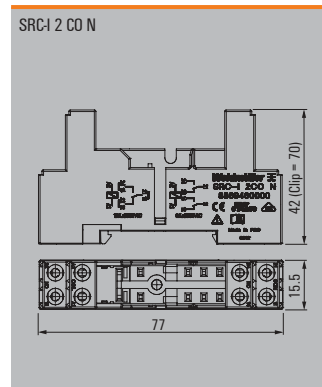

Dimensions in mm

LED and protective modules for the SRC-I plug-in frame

Simply plug into the base module; reverse-connect protection. Connect parallel to coil.

Ordering data

Description
Free Wheel diode 1N4007
Resistor 100 kΩ 1 Watt
RC-element 6 ... 60 V AC; 470 Ω / 220 nF
RC-element 110 ... 230 V AC; 4.7 Ω / 10 nF
Varistor protection 24 V; S07K30
Varistor protection 110 V; S07K130
Varistor protection 230 V; S07K275
LED
LED 6 ... 24 V DC with free wheel diode
LED 24 ... 60 V DC with free wheel diode
LED 110 ... 230 V DC with free wheel diode
LED 6 ... 24 V DC / V AC
LED 24 ... 60 V DC / V AC
LED 110 ... 230 V DC / V AC

Type	Qty.	Order No.	Order No.
RIM-I 1 6/230V	10	8869580000	
RIM-I 1 R 110/230V	10	8870830000	
RIM-I 3 6/60VAC	10	8869770000	
RIM-I 3 110/230VAC	10	8869790000	
RIM-I 4 24VUC	10	8869710000	
RIM-I 4 110VUC	10	8869730000	
RIM-I 4 230VUC	10	8869750000	
		red	green
RIM-I 2 6/24VDC	10	8869590000	8869600000
RIM-I 2 24/60VDC	10	8869670000	8869680000
RIM-I 2 110/230VDC	10	8869690000	8869700000
RIM-I 3 6/24VUC	10	8869630000	8869640000
RIM-I 3 24/60VUC	10	8869610000	8869620000
RIM-I 3 110/230VUC	10	8869650000	8869660000

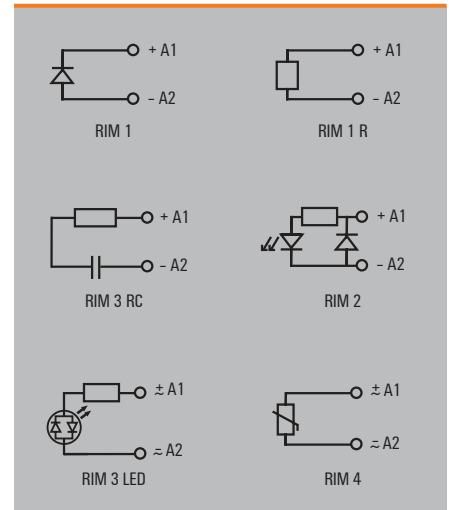
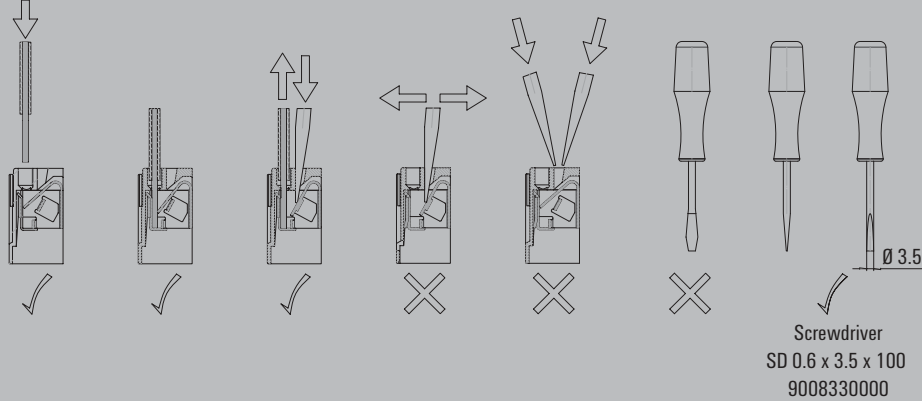
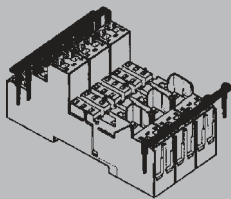
**Warnings and notes on usage****Handling the PUSH IN connection****Cross-connector mounting for PUSH IN base**

If more than two poles need to be connected with stacked cross-connector ridges, then the lower ridge must be stripped and shortened to the proper length so it will fit.

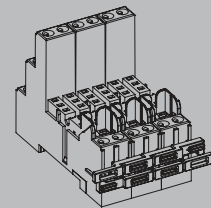
Cross-connector mounting for screw base

RCl relay

1 CO AC/DC coil

- 4000 VA switching capacity
- Stable plug-in connections
- Optional test button with latching function and inspection window
- Optional status indicator (AC red/ DC green)
- Optional protective suppressor circuit
- Identification of coils (AC red / DC blue)



Circuit diagram

View on solder pins
dimensions in mm

1 C/O changeover contacts

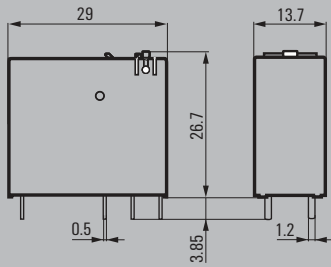
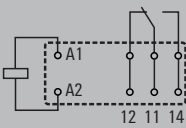

Technical data

Output	
Rated switching voltage	240 V AC
Max. switching voltage, AC	400 V
Continuous current	16 A
Contact material	AgNi 90/10
Mechanical service life	AC coil 5 x 10 ⁶ switch. ops, DC coil 10 x 10 ⁶ switch. cycles
Sparkover time / Drop-out time	8 ms / 6 ms
Rated data	
Ambient temperature (operational)	-40 °C...+70 °C
Flammability class UL94	V-0
Humidity	40 °C / 93 % rel. humidity, no condensation
Approvals	CSA; cURus; VDE
Insulation coordination (EN 50 178)	
Rated voltage	250 V
Clearance and creepage distances for control side - load side	> 8 mm
Surge voltage category	III
Pollution severity	3

Dimensions	Plug-in connection
Length x width x height	mm 29 / 13.7 / x
Note	x = 25.5 without test button / 26.7 with test button

Applications

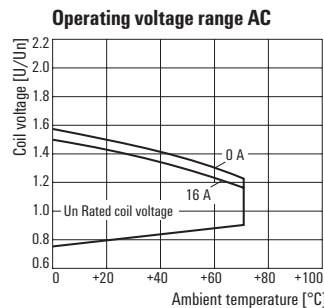
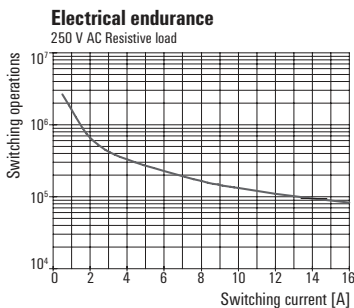
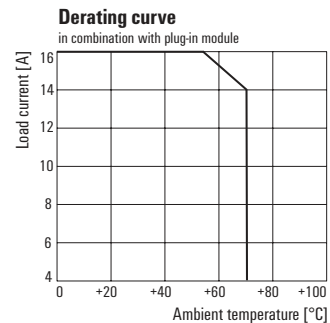
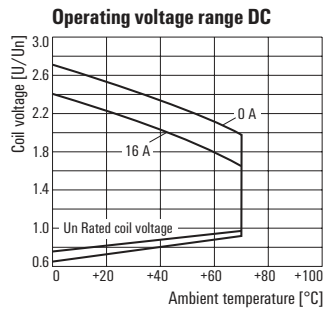
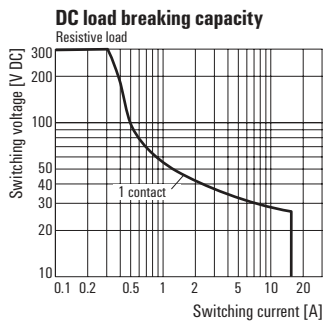

RCI relay

1 CO AC/DC coil

Type code	RCI				
Type	RIDER Control Industrial				
Type of construction	3 1-pole, 16 A 4 2-pole, 8 A				
Type of contact	1 1 CO contact without test button 2 2 CO contacts without test button 7 1 CO contact with test button 8 2 CO contacts with test button				
Contact material	4 AgNi 90/10				
Coil	012 12 V DC 024 24 V DC 048 48 V DC 110 110 V DC 524 24 V AC 615 115 V AC 730 230 V AC AB2 12 V DC+LED+diode AC4 24 V DC+LED+diode AE8 48 V DC+LED+diode BB0 110 V DC+LED+diode R24 24 V AC+LED S15 115 V AC+LED T30 230 V AC+LED				

Ordering data

Input	12 V DC 1CO	24 V DC 1CO	48 V DC 1CO	110 V DC 1CO
Rated control voltage	12 V DC	24 V DC	48 V DC	110 V DC
DC Response/dropout Volt	8.4 V / 1.2 V	16.8 V / 2.4 V	33.6 V / 4.8 V	77 V / 11 V
Power rating	400 mW	400 mW	400 mW	400 mW
Rated current DC	33.3 mA	16.7 mA	8.7 mA	4.1 mA
Coil resistance	360 Ω ±10 %	1440 Ω ±10 %	5520 Ω ±10 %	28800 Ω ±12 %

Ordering data				
Relay				
Standard	Type	RCI314012	RCI314024	RCI314048
	Order No.	886980000	8869810000	8869820000
w. test button	Type	RCI374012	RCI374024	RCI374048
	Order No.	8869950000	8869960000	8869970000
With LED + freewheel diode	Type	RCI314AB2	RCI314AC4	RCI314AE8
	Order No.	8870090000	8870100000	8870110000
With test button + LED	Type	RCI374AB2	RCI374AC4	RCI374AE8
+ Free-wheel diode	Order No.	8870240000	8870250000	8870260000

Note				

Ordering data

Input	24 V AC 1CO	115 V AC 1CO	230 V AC 1CO
Rated control voltage	24 V AC	115 V AC	230 V AC
AC Response/dropout Volt	18 V / 3.6 V	86.3 V / 17.3 V	172.5 V / 34.5 V
Power rating	0.75 VA	0.75 VA	0.75 VA
Rated current AC	31.6 mA	6.6 mA	3.2 mA
Coil resistance	350 Ω ±10 %	8100 Ω ±15 %	32500 Ω ±15 %

Ordering data			
Relay			
Standard	Type	RCI314524	RCI314615
	Order No.	8869840000	8869850000
w. test button	Type	RCI374524	RCI374615
	Order No.	8869990000	8870000000
with LED	Type	RCI314R24	RCI314S15
	Order No.	8870130000	8870140000
With test button + LED	Type	RCI374R24	RCI374S15
	Order No.	8870280000	8870290000

Note			

RCl relay

2 CO AC/DC coil

- 2000 VA switching capacity
- Stable plug-in connections
- Optional test button with latching function and inspection window
- Optional status indicator (AC red / DC green)
- Optional protective suppressor circuit
- Identification of coils (AC red / DC blue)



Industrial relay modules and solid-state relays

B

Circuit diagram

View on solder pins
dimensions in mm

2 C/O changeover contacts

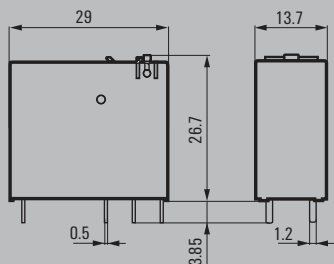
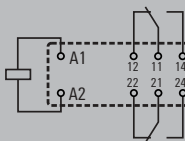

Technical data

Output	
Rated switching voltage	240 V AC
Max. switching voltage, AC	400 V
Continuous current	8 A
Contact material	AgNi 90/10
Mechanical service life	AC coil 5 x 10 ⁶ switch. ops, DC coil 10 x 10 ⁶ switch. cycles
Sparkover time / Drop-out time	10 ms / 4 ms
Rated data	
Ambient temperature (operational)	-40 °C...+70 °C
Flammability class UL94	V-0
Humidity	40 °C / 93 % rel. humidity, no condensation
Approvals	CSA; cURus; VDE
Insulation coordination (EN 50 178)	
Rated voltage	250 V
Clearance and creepage distances for control side - load side	> 8 mm
Surge voltage category	III
Pollution severity	3

Dimensions	Plug-in connection
Length x width x height	mm 29 / 13.7 / x
Note	x = 25.5 without test button / 26.7 with test button

Applications

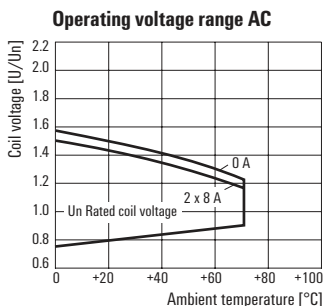
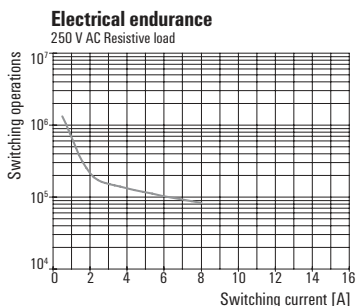
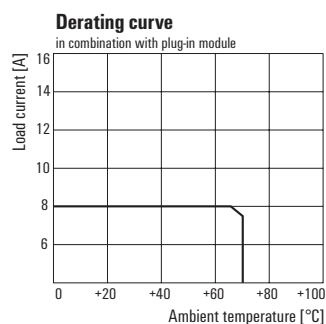
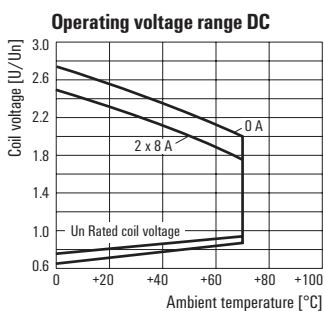
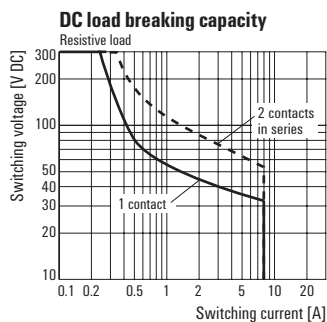

RCI relay

2 CO AC/DC coil

Type code	RCI				
Type	RIDER Control Industrial				
Type of construction	3 1-pole, 16 A				
	4 2-pole, 8 A				
Type of contact	1 1 CO contact without test button				
	2 2 CO contacts without test button				
	7 1 CO contact with test button				
	8 2 CO contacts with test button				
Contact material	4 AgNi 90/10				
Coil					
	012 12 V DC				
	024 24 V DC				
	048 48 V DC				
	110 110 V DC				
	524 24 V AC				
	615 115 V AC				
	730 230 V AC				
	AB2 12 V DC+LED+diode				
	AC4 24 V DC+LED+diode				
	AE8 48 V DC+LED+diode				
	B80 110 V DC+LED+diode				
	R24 24 V AC+LED				
	S15 115 V AC+LED				
	T30 230 V AC+LED				

Ordering data

Input	12 V DC 2CO	24 V DC 2CO	48 V DC 2CO	110 V DC 2CO
Rated control voltage	12 V DC	24 V DC	48 V DC	110 V DC
DC Response/dropout Volt	8.4 V / 1.2 V	16.8 V / 2.4 V	33.6 V / 4.8 V	77 V / 11 V
Power rating	400 mW	400 mW	400 mW	400 mW
Rated current DC	33.3 mA	16.7 mA	8.7 mA	4.1 mA
Coil resistance	360 Ω ±10 %	1440 Ω ±10 %	5520 Ω ±10 %	28800 Ω ±12 %

Ordering data				
Relay				
Standard	Type	RCI424012	RCI424024	RCI424048
	Order No.	8869870000	8869890000	8869900000
w. test button	Type	RCI484012	RCI484024	RCI484048
	Order No.	8870020000	8870030000	8870040000
With LED + freewheel diode	Type	RCI424AB2	RCI424AC4	RCI424AE8
	Order No.	8870170000	8870180000	8870190000
With test button + LED	Type	RCI484AB2	RCI484AC4	RCI484AE8
+ Free-wheel diode	Order No.	8870310000	8870320000	8870330000

Note				

Ordering data

Input	24 V AC 2CO	115 V AC 2CO	230 V AC 2CO
Rated control voltage	24 V AC	115 V AC	230 V AC
AC Response/dropout Volt	18 V / 3.6 V	86.3 V / 17.3 V	172.5 V / 34.5 V
Power rating	0.75 VA	0.75 VA	0.75 VA
Rated current AC	31.6 mA	6.6 mA	3.2 mA
Coil resistance	350 Ω ±10 %	8100 Ω ±15 %	32500 Ω ±15 %

Ordering data			
Relay			
Standard	Type	RCI424524	RCI424615
	Order No.	8869920000	8869930000
w. test button	Type	RCI484524	RCI484615
	Order No.	8870060000	8870070000
with LED	Type	RCI424R24	RCI424S15
	Order No.	8870210000	8870220000
With test button + LED	Type	RCI484R24	RCI484S15
	Order No.	8870350000	8870360000

Note			

RCM KIT

2 CO AC/DC coil

Modular system comprising:

- Relay socket for rail mounting
- LED display unit (AC red / DC green)
- Retaining clip
- Pluggable relays with coil identification (AC red / DC blue)
- Markers

Independent of connection system:

- Screw or PUSH IN connection system



Technical data

Output	
Rated switching voltage	240 V AC
Max. switching voltage, AC	400 V
Continuous current	12 A
Contact material	AgNi 90/10
Mechanical service life	AC coil 20 x 10 ⁶ switch. ops, DC coil 30 x 10 ⁶ switch. cycles
Sparkover time / Drop-out time	15 ms / 10 ms
Rated data	
Status indicator / Free-wheel diode	Green LED = DC coil; red LED = AC coil / Yes
Ambient temperature (operational)	-40 °C...+70 °C
Flammability class UL94	V-0
Humidity	40 °C / 93 % rel. humidity, no condensation
Approvals	CE; GL
Insulation coordination (EN 50 178)	
Rated voltage	240 V
Clearance and creepage distances for control side - load side	≥ 4 mm
Surge voltage category	III
Pollution severity	2

Dimensions	Screw connection	PUSH IN spring connection
Clamping range (nominal / min. / max.)	mm ² 2.5 / 0.5 / 2.5	1.5 / 0.5 / 1.5
Length x width x height	mm 75 / 28 / 82	96 / 28 / 98

Note

DC-Version

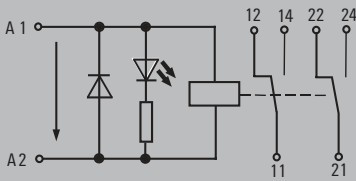

AC-Version

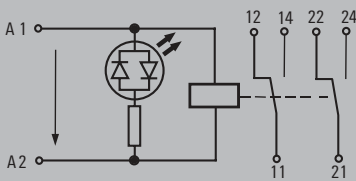

Ordering data

Input	24 V DC 2CO LED	24 V AC 2CO LED	115 V AC 2CO LED	230 V AC 2CO LED
Rated control voltage	24 V DC	24 V AC	115 V AC	230 V AC
Rated current AC		41.6 mA	8.8 mA	4.3 mA
Rated current DC	31.3 mA			
Power rating	740 mW	1.0 VA	1.0 VA	1.0 VA
AC Response/dropout Volt		19.2 V / 7.2 V	92 V / 34.5 V	184.0 V / 69.0 V
DC Response/dropout Volt	18.0 V / 2.4 V			

Ordering data		24 V DC 2CO LED	24 V AC 2CO LED	115 V AC 2CO LED	230 V AC 2CO LED
Relay with socket					
Screw connection	Type	RCMKIT-I 24VDC 2CO LD	RCMKIT-I 24VAC 2CO LD	RCMKIT-I 115VAC 2CO LD	RCMKIT-I 230VAC 2CO LD
	Order No.	8920940000	8920950000	8920960000	8920970000
PUSH IN connection	Type	RCMKITP-I 24VDC 2CO LD	RCMKITP-I 24VAC 2CO LD	RCMKITP-I 115VAC 2CO LD	RCMKITP-I 230VAC 2CO LD
	Order No.	8921080000	8921090000	8921100000	8921110000

Ordering data		24 V DC 2CO LED	24 V AC 2CO LED	115 V AC 2CO LED	230 V AC 2CO LED
Spare relay (pluggable)					
	Type	RCM270024	RCM270524	RCM270615	RCM270730
	Order No.	8689860000	8689760000	8689800000	8689820000

Note		24 V DC 2CO LED	24 V AC 2CO LED	115 V AC 2CO LED	230 V AC 2CO LED

Accessories for RCM KIT relay modules, 2 CO

Plug-in module with PUSH IN connection

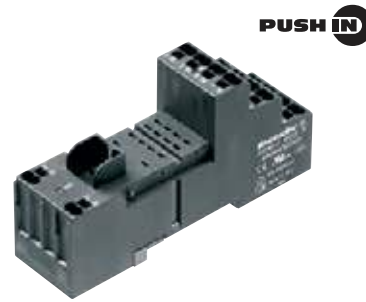

Plug-in module with screw connection





Technical data

Rated current	12 A	12 A
Rated voltage	240 V AC	240 V AC
Dielectric strength of coil contacts	> 2500 V _{eff}	> 2500 V _{eff}
Ambient temperature (operational)	-45...+70 °C	-45...+70 °C
Insulation group (VDE 0110b)	C / 250 V AC	C / 250 V AC
Protection class (IEC 61810)	IP20	IP20
Stripping length	12 mm	8 mm
Approvals	VDE, cURus, CSA	VDE, cURus, CSA
Connection cross-section		
- Solid-core wire	1 x 0.75/1/1.5 mm ² / 2 x 0.75/1 mm ²	2 x 2.5 mm ²
- Stranded wire	1 x 0.75/1/1.5 mm ² / 2 x 0.75/1 mm ²	2 x 2.5 mm ²
- with ferrule	1 x 0.75/1 mm ² / 2 x 0.75 mm ²	2 x 1.5 mm ²
Rated torque acc. to IEC 61984 for screw connection		0.5 Nm / max. 0.7 Nm
Plug-in cycles	A (10)	A (10)

Ordering data

Description	Type	Qty.	Order No.
Plug-in module, snaps onto TS35 DIN mounting rail, 2-pole	SCM-H 2CO P		8876220000
			8869400000

Accessories

Description	Type	Qty.	Order No.
Plastic retaining clip	SCM-H CLIP P	10	8869440000
Metal retaining clip	SCM-H CLIP M	10	8869450000
Marker	SCM-H MARK	10	8869460000
Marker, Multicard	ESG 9/11 K MC neutral	200	1857440000
 Cross-connector for PUSH IN base, 2-pole, 12 A	SCM-H QV P	10	8870850000
 Cross-connector for screw base, 6-pole			
			1132080000

Dimensions

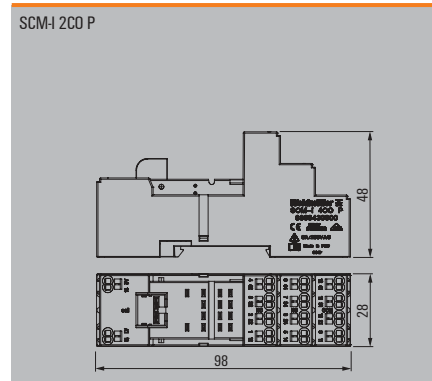

Dimensions

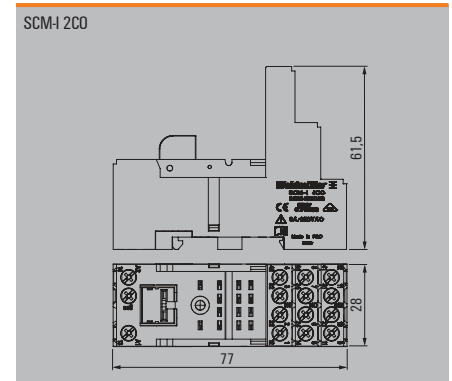

Dimensions in mm

LED and protective modules for the SCM-I plug-in frame

Plug simply into the base module; reverse-connect protection. Connect parallel to coil.

Ordering data

Description
Free Wheel diode 1N4007
Resistor 100 kΩ 1 Watt
RC element 6 ... 60 V AC; 470 Ω / 220 nF
RC element 110 ... 230 V AC; 4.7 Ω / 10 nF
Varistor protection 24 V; S07K30
Varistor protection 110 V; S07K130
Varistor protection 230 V; S07K275
LED
LED 6 ... 24 V DC with free wheel diode
LED 24 ... 60 V DC with free wheel diode
LED 110 ... 230 V DC with free wheel diode
LED 6 ... 24 V DC / V AC
LED 24 ... 60 V DC / V AC
LED 110 ... 230 V DC / V AC

Type	Qty.	Order No.	Order No.
RIM-I 1 6/230V	10	8869580000	
RIM-I 1 R 110/230V	10	8870830000	
RIM-I 3 6/60VAC	10	8869770000	
RIM-I 3 110/230VAC	10	8869790000	
RIM-I 4 24VUC	10	8869710000	
RIM-I 4 110VUC	10	8869730000	
RIM-I 4 230VUC	10	8869750000	
		red	green
RIM-I 2 6/24VDC	10	8869590000	8869600000
RIM-I 2 24/60VDC	10	8869670000	8869680000
RIM-I 2 110/230VDC	10	8869690000	8869700000
RIM-I 3 6/24VUC	10	8869630000	8869640000
RIM-I 3 24/60VUC	10	8869610000	8869620000
RIM-I 3 110/230VUC	10	8869650000	8869660000

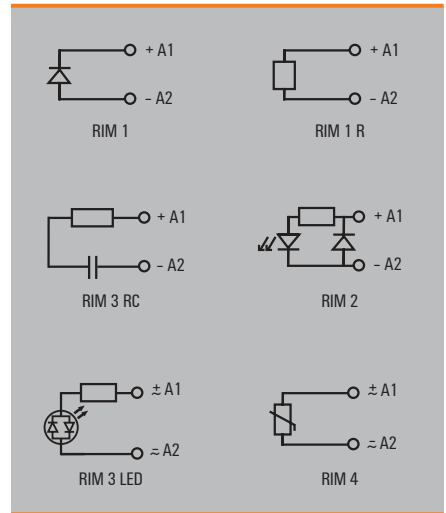

Warnings and notes on usage

Handling the PUSH IN connection

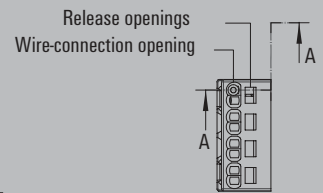
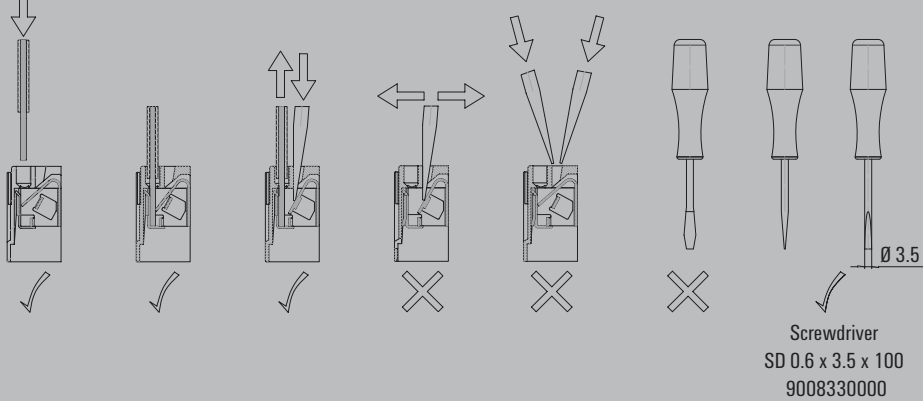

Cross-connector mounting for PUSH IN base

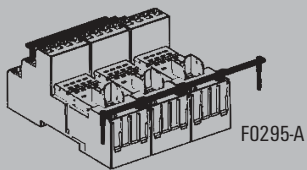

If more than two poles need to be connected with stacked cross-connector ridges, then the lower ridge must be stripped and shortened to the proper length so it will fit.

Cross-connector mounting for screw base

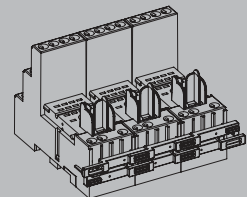

RCM KIT**3 CO AC/DC coil**

Modular system comprising:

- Relay socket for rail mounting
- LED display unit (AC red / DC green)
- Retaining clip
- Pluggable relay modules
- Identification of coils (AC red / DC blue)
- Markers

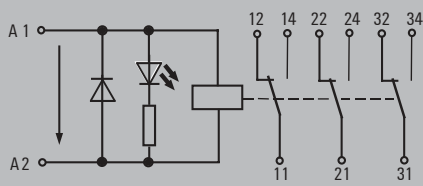
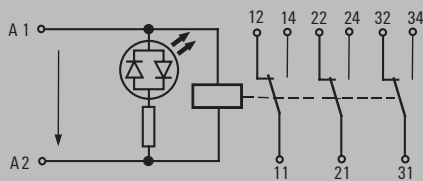
**DC-Version****AC-Version****Technical data**

Output	
Rated switching voltage	240 V AC
Max. switching voltage, AC	400 V
Continuous current	10 A
Contact material	AgNi 90/10
Mechanical service life	AC coil 20 x 10 ⁶ switch. ops, DC coil 30 x 10 ⁶ switch. cycles
Sparkover time / Drop-out time	15 ms / 10 ms
Rated data	
Status indicator / Free-wheel diode	Green LED = DC coil; red LED = AC coil / Yes
Ambient temperature (operational)	-40 °C...+70 °C
Flammability class UL94	V-0
Humidity	40 °C / 93 % rel. humidity, no condensation
Approvals	CE; GL
Insulation coordination (EN 50 178)	
Rated voltage	240 V
Clearance and creepage distances for control side - load side	≥ 4 mm
Surge voltage category	III
Pollution severity	2

Dimensions	Screw connection	
Clamping range (nominal / min. / max.)	mm ²	2.5 / 0.5 / 2.5
Length x width x height	mm	75 / 28 / 82

Note**Ordering data**

Input	24 V DC 3CO LED	24 V AC 3CO LED	115 V AC 3CO LED	230 V AC 3CO LED
Rated control voltage	24 V DC	24 V AC	115 V AC	230 V AC
Rated current AC		41.6 mA	8.8 mA	4.3 mA
Rated current DC	31.3 mA			
Power rating	740 mW	1.0 VA	1.0 VA	1.0 VA
AC Response/dropout Volt		19.2 V / 7.2 V	92 V / 34.5 V	184.0 V / 69.0 V
DC Response/dropout Volt	18.0 V / 2.4 V			

Ordering data**Relay with socket**

Screw connection	Type	Type	Type	Type
	RCMKIT-I 24VDC 3CO LD	RCMKIT-I 24VAC 3CO LD	RCMKIT-I 115VAC 3CO LD	RCMKIT-I 230VAC 3CO LD
Order No.	8920980000	8920990000	8921010000	8921020000
Order No.				

Ordering data**Spare relay (pluggable)**

Type	Type	Type	Type
RCM370024	RCM370524	RCM370615	RCM370730
8690040000	8690030000	8689980000	8690000000

Note

Accessories for
RCM KIT relay modules, 3 CO

Plug-in module with screw connection



Technical data

Rated current	10 A
Rated voltage	240 V AC
Dielectric strength of coil contacts	> 2500 V _{eff}
Ambient temperature (operational)	-45...+70 °C
Insulation group (VDE 0110b)	C / 250 V AC
Protection class (IEC 61810)	IP20
Approvals	VDE, cURus, CSA
Connection cross-section	
- Solid-core wire	2 x 2.5 mm ²
- Stranded wire	2 x 2.5 mm ²
- with ferrule	2 x 1.5 mm ²
Rated torque acc. to IEC 61984 for screw connection	0.5 Nm / max. 0.7 Nm
Plug-in cycles	A (10)

Ordering data

Description	Type	Qty.	Order No.
Plug-in module, snaps onto TS35 DIN mounting rail, 3-pole	SCM-H 3CO N		8869410000

Accessories

Description	Type	Qty.	Order No.
Plastic retaining clip	SCM-H CLIP N	10	8875620000
Metal retaining clip	SCM-H CLIP M	10	8869450000
Marker	SCM-H MARK	10	8869460000
Marker, Multicard	ESG 9/11 K MC neutral	200	1857440000
 Cross-connector for screw base, 6-pole	SCM-H QV S	10	1132080000

Dimensions

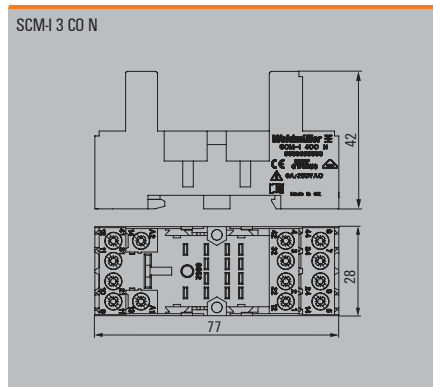

Dimensions in mm

LED and protective modules for the SCM-I plug-in frame

Simply plug into the base module; reverse-connect protection. Connect parallel to coil.

Ordering data

Description
Free Wheel diode 1N4007
Resistor 100 kΩ 1 Watt
RC element 6 ... 60 V AC; 470 Ω / 220 nF
RC element 110 ... 230 V AC; 4.7 Ω / 10 nF
Varistor protection 24 V; S07K30
Varistor protection 110 V; S07K130
Varistor protection 230 V; S07K275
LED
LED 6 ... 24 V DC with free wheel diode
LED 24 ... 60 V DC with free wheel diode
LED 110 ... 230 V DC with free wheel diode
LED 6 ... 24 V DC / V AC
LED 24 ... 60 V DC / V AC
LED 110 ... 230 V DC / V AC

Type	Qty.	Order No.	Order No.
RIM-I 1 6/230V	10	8869580000	
RIM-I 1 R 110/230V	10	8870830000	
RIM-I 3 6/60VAC	10	8869770000	
RIM-I 3 110/230VAC	10	8869790000	
RIM-I 4 24VUC	10	8869710000	
RIM-I 4 110VUC	10	8869730000	
RIM-I 4 230VUC	10	8869750000	
		red	green
RIM-I 2 6/24VDC	10	8869590000	8869600000
RIM-I 2 24/60VDC	10	8869670000	8869680000
RIM-I 2 110/230VDC	10	8869690000	8869700000
RIM-I 3 6/24VUC	10	8869630000	8869640000
RIM-I 3 24/60VUC	10	8869610000	8869620000
RIM-I 3 110/230VUC	10	8869650000	8869660000

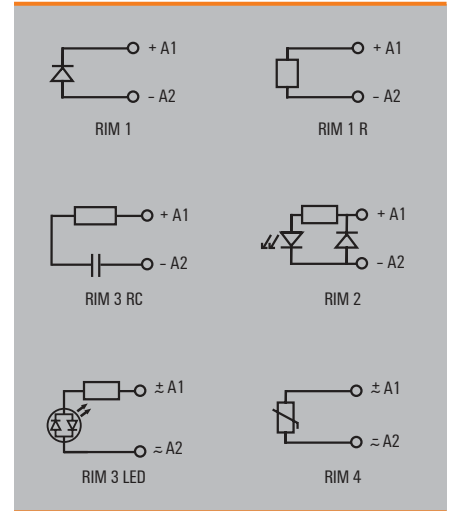

Warnings and notes on usage

Cross-connector mounting for screw base

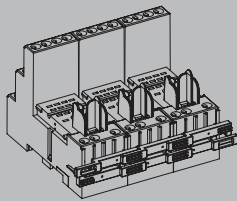

RCM KIT

4 CO AC/DC coil

Modular system comprising:

- Relay socket for rail mounting
- LED display unit (AC red / DC green)
- Retaining clip
- Pluggable relay modules
- Identification of coils (AC red / DC blue)
- Markers

Choice of connection system:

- Screw or PUSH IN connection system



Technical data

Output	
Rated switching voltage	240 V AC
Max. switching voltage, AC	240 V
Continuous current	6 A
Contact material	AgNi 90/10
Mechanical service life	AC coil 20 x 10 ⁶ switch. ops, DC coil 30 x 10 ⁶ switch. cycles
Sparkover time / Drop-out time	15 ms / 10 ms
Rated data	
Status indicator / Free-wheel diode	Green LED = DC coil; red LED = AC coil / Yes
Ambient temperature (operational)	-40 °C...+70 °C
Flammability class UL94	V-0
Humidity	40 °C / 93 % rel. humidity, no condensation
Approvals	CE; GL
Insulation coordination (EN 50 178)	
Rated voltage	240 V
Clearance and creepage distances for control side - load side	≥ 4 mm
Surge voltage category	III
Pollution severity	2

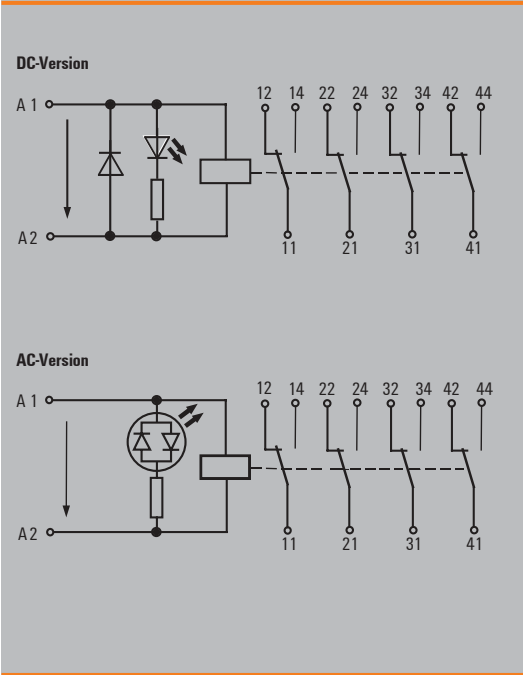

Dimensions	Screw connection	PUSH IN spring connection
Clamping range (nominal / min. / max.)	mm ² 2.5 / 0.5 / 2.5	1.5 / 0.5 / 1.5
Length x width x height	mm 75 / 28 / 82	96 / 28 / 98
Note		

Ordering data

Input	24 V DC 4CO LED	24 V AC 4CO LED	115 V AC 4CO LED	230 V AC 4CO LED
Rated control voltage	24 V DC	24 V AC	115 V AC	230 V AC
Rated current AC		41.6 mA	8.8 mA	4.3 mA
Rated current DC	31.3 mA			
Power rating	740 mW	1.0 VA	1.0 VA	1.0 VA
AC Response/dropout Volt		19.2 V / 7.2 V	92 V / 34.5 V	184.0 V / 69.0 V
DC Response/dropout Volt	18.0 V / 2.4 V			

Ordering data		24 V DC 4CO LED	24 V AC 4CO LED	115 V AC 4CO LED	230 V AC 4CO LED
Relay with socket					
Screw connection	Type	RCMKIT-I 24VDC 4CO LD	RCMKIT-I 24VAC 4CO LD	RCMKIT-I 115VAC 4CO LD	RCMKIT-I 230VAC 4CO LD
	Order No.	8921030000	8921040000	8921050000	8921060000
PUSH IN connection	Type	RCMKITP-I 24VDC 4CO LD	RCMKITP-I 24VAC 4CO LD	RCMKITP-I 115VAC 4CO LD	RCMKITP-I 230VAC 4CO LD
	Order No.	8921120000	8921130000	8921140000	8921150000

Ordering data		24 V DC 4CO LED	24 V AC 4CO LED	115 V AC 4CO LED	230 V AC 4CO LED
Spare relay (pluggable)					
	Type	RCM570024	RCM570524	RCM570615	RCM570730
	Order No.	8690200000	8690110000	1180800000	1181100000

Note		24 V DC 4CO LED	24 V AC 4CO LED	115 V AC 4CO LED	230 V AC 4CO LED

Accessories for RCM KIT relay modules, 4 CO

Plug-in module with PUSH IN connection

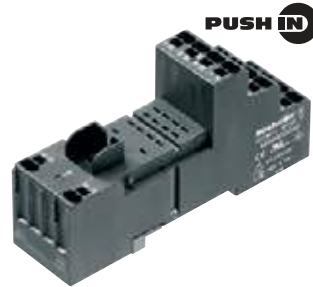

Plug-in module with screw connection

Standard height



Plug-in module with screw connection

Low height



Technical data

Rated current	6 A
Rated voltage	240 V AC
Dielectric strength of coil contacts	> 2500 V _{eff}
Ambient temperature (operational)	-45...+70 °C
Insulation group (VDE 0110b)	C / 250 V AC
Protection class (IEC 61810)	IP20
Stripping length	12 mm
Approvals	VDE, cURus, CSA
Connection cross-section	
- Solid-core wire	1 x 0.75/1/1.5 mm ² / 2 x 0.75/1 mm ²
- Stranded wire	1 x 0.75/1/1.5 mm ² / 2 x 0.75/1 mm ²
- with ferrule	1 x 0.75/1 mm ² / 2 x 0.75 mm ²
Rated torque acc. to IEC 61984 for screw connection	
Plug-in cycles	A (10)

Rated current	6 A
Rated voltage	240 V AC
Dielectric strength of coil contacts	> 2500 V _{eff}
Ambient temperature (operational)	-45...+70 °C
Insulation group (VDE 0110b)	C / 250 V AC
Protection class (IEC 61810)	IP20
Stripping length	12 mm
Approvals	VDE, cURus, CSA
Connection cross-section	
- Solid-core wire	1 x 0.75/1/1.5 mm ² / 2 x 0.75/1 mm ²
- Stranded wire	1 x 0.75/1/1.5 mm ² / 2 x 0.75/1 mm ²
- with ferrule	1 x 0.75/1 mm ² / 2 x 0.75 mm ²
Rated torque acc. to IEC 61984 for screw connection	
Plug-in cycles	A (10)

Rated current	6 A
Rated voltage	240 V AC
Dielectric strength of coil contacts	> 2500 V _{eff}
Ambient temperature (operational)	-45...+70 °C
Insulation group (VDE 0110b)	C / 250 V AC
Protection class (IEC 61810)	IP20
Stripping length	8 mm
Approvals	VDE, cURus, CSA
Connection cross-section	
- Solid-core wire	2 x 2.5 mm ²
- Stranded wire	2 x 2.5 mm ²
- with ferrule	2 x 1.5 mm ²
Rated torque acc. to IEC 61984 for screw connection	0.5 Nm / max. 0.7 Nm
Plug-in cycles	A (10)

Rated current	6 A
Rated voltage	240 V AC
Dielectric strength of coil contacts	> 2500 V _{eff}
Ambient temperature (operational)	-45...+70 °C
Insulation group (VDE 0110b)	C / 250 V AC
Protection class (IEC 61810)	IP20
Stripping length	8 mm
Approvals	VDE, cURus, CSA
Connection cross-section	
- Solid-core wire	2 x 2.5 mm ²
- Stranded wire	2 x 2.5 mm ²
- with ferrule	2 x 1.5 mm ²
Rated torque acc. to IEC 61984 for screw connection	0.5 Nm / max. 0.7 Nm
Plug-in cycles	A (10)

Ordering data

Description
Plug-in module, snaps onto TS35 DIN mounting rail, 4-pole

Type	Qty.	Order No.
SCM-I 4CO P		8869430000

Type	Qty.	Order No.
SCM-I 4CO		8869420000

Type	Qty.	Order No.
SCM-I 4CO N		8869390000

Accessories

Description
Plastic retaining clip
Plastic retaining clip
Metal retaining clip
Marker
Marker, Multicard

Type	Qty.	Order No.
SCM-I CLIP P	10	8869440000
SCM-I CLIP M	10	8869450000
SCM-I MARK	10	8869460000
ESG 9/11 K MC neutral	200	1857440000
SCM-I QV P		8870850000

Type	Qty.	Order No.
SCM-I CLIP P	10	8869440000
SCM-I CLIP M	10	8869450000
SCM-I MARK	10	8869460000
ESG 9/11 K MC neutral	200	1857440000
SCM-I QV S		1132080000

Type	Qty.	Order No.
SCM-I CLIP N	10	8875620000
SCM-I CLIP M	10	8869450000
SCM-I MARK	10	8869460000
ESG 9/11 K MC neutral	200	1857440000
SCM-I QV S		1132080000

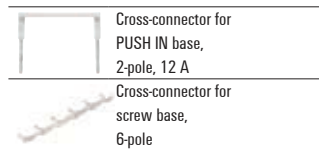

Dimensions

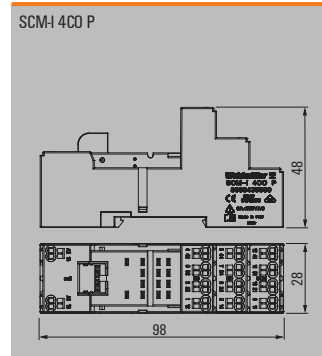

Dimensions

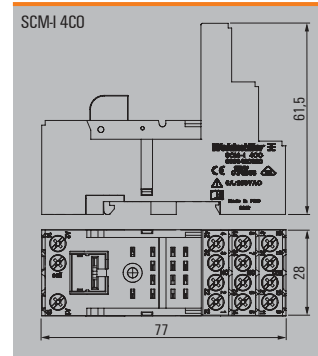

Dimensions

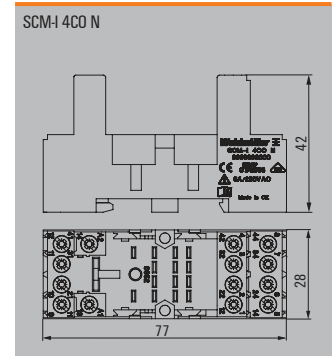

Dimensions in mm

LED and protective modules for the SCM-I plug-in frame

Simply plug into the base module; reverse-connect protection. Connect parallel to coil.

Ordering data

Description
Free Wheel diode 1N4007
Resistor 100 kΩ 1 Watt
RC element 6 ... 60 V AC; 470 Ω / 220 nF
RC element 110 ... 230 V AC; 4.7 Ω / 10 nF
Varistor protection 24 V; S07K30
Varistor protection 110 V; S07K130
Varistor protection 230 V; S07K275
LED
LED 6 ... 24 V DC with free wheel diode
LED 24 ... 60 V DC with free wheel diode
LED 110 ... 230 V DC with free wheel diode
LED 6 ... 24 V DC / V AC
LED 24 ... 60 V DC / V AC
LED 110 ... 230 V DC / V AC

Type	Qty.	Order No.	Order No.
RIM-I 1 6/230V	10	8869580000	
RIM-I 1 R 110/230V	10	8870830000	
RIM-I 3 6/60VAC	10	8869770000	
RIM-I 3 110/230VAC	10	8869790000	
RIM-I 4 24VUC	10	8869710000	
RIM-I 4 110VUC	10	8869730000	
RIM-I 4 230VUC	10	8869750000	
		red	green
RIM-I 2 6/24VDC	10	8869590000	8869600000
RIM-I 2 24/60VDC	10	8869670000	8869680000
RIM-I 2 110/230VDC	10	8869690000	8869700000
RIM-I 3 6/24VUC	10	8869630000	8869640000
RIM-I 3 24/60VUC	10	8869610000	8869620000
RIM-I 3 110/230VUC	10	8869650000	8869660000

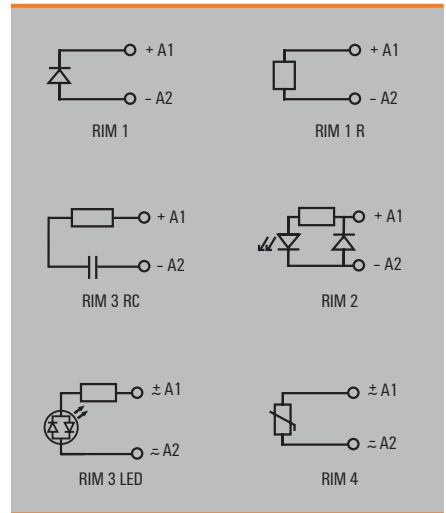

Warnings and notes on usage

Handling the PUSH IN connection

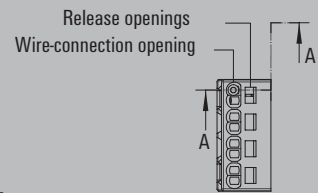
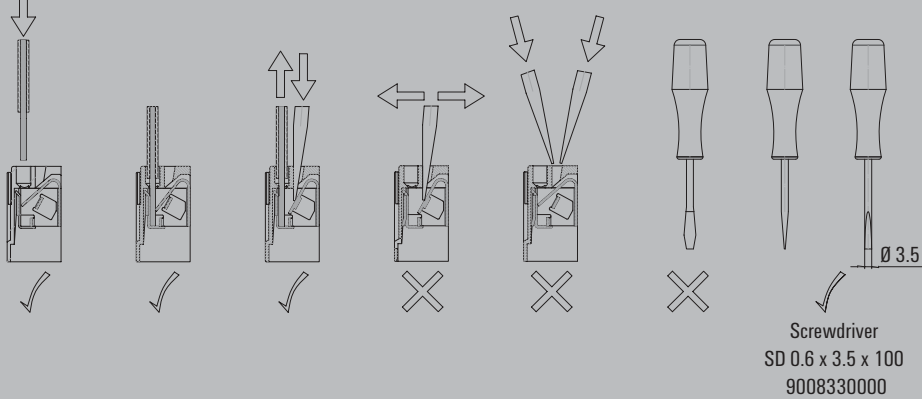

Cross-connector mounting for PUSH IN base

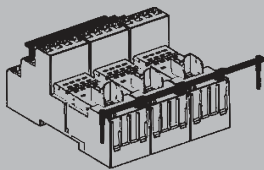

If more than two poles need to be connected with stacked cross-connector ridges, then the lower ridge must be stripped and shortened to the proper length so it will fit.

Cross-connector mounting for screw base

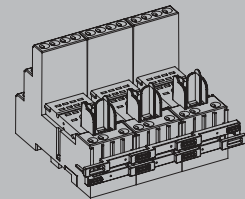

RCM relay

2 CO

AC/DC coil

- 3000 VA switching capacity
- Solder and plug connection
- Safe-to-touch test button, selectable locking
- White labelling panel
- Identification of coils (AC red / DC blue)



Industrial relay modules and solid-state relays

B

Circuit diagram

Dimensions in mm

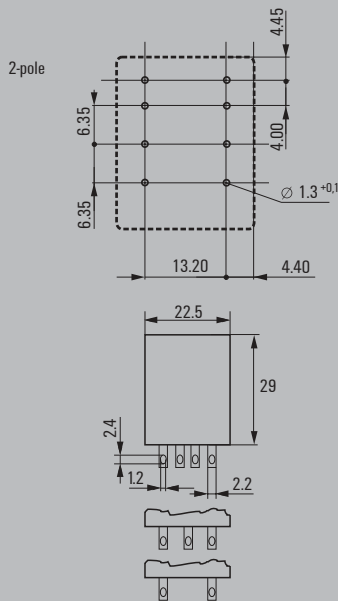

Technical data

Output	
Rated switching voltage	240 V AC
Max. switching voltage, AC	400 V
Continuous current	12 A
Contact material	AgNi 90/10
Mechanical service life	AC coil 20 x 10 ⁶ switch. ops, DC coil 30 x 10 ⁶ switch. cycles
Sparkover time / Drop-out time	15 ms / 10 ms
Rated data	
Ambient temperature (operational)	-40 °C...+70 °C
Flammability class UL94	V-0
Humidity	40 °C / 93 % rel. humidity, no condensation
Approvals	CSA; cURus; VDE
Insulation coordination (EN 50 178)	
Rated voltage	250 V
Clearance and creepage distances for control side - load side	≥ 4 mm
Surge voltage category	
Pollution severity	

Dimensions	Plug-in connection
Length x width x height	mm 28 / 22.5 / 29
Note	

Applications

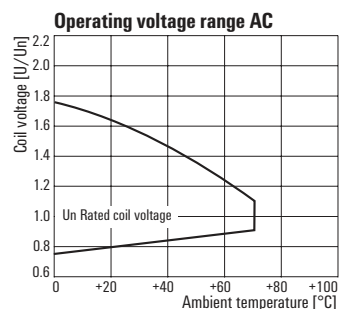
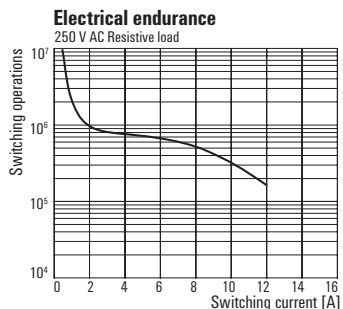
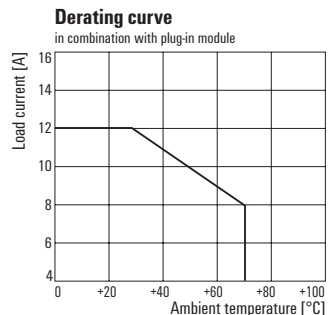
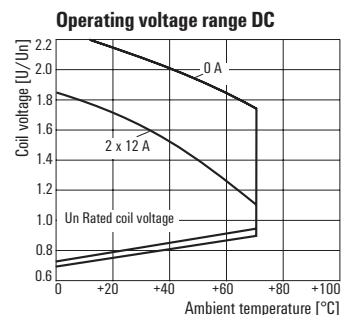
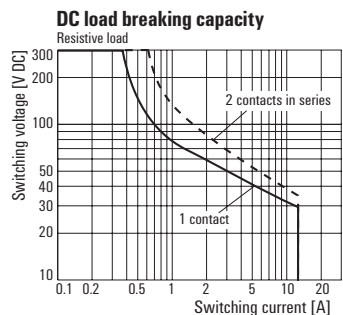

RCM relay
2 CO
AC/DC coil

Type code	RCM								
Type	RIDER Control Multiple								
Contacts	2 2 CO contacts								
	3 3 CO contacts								
	5 4 CO contacts								
Contact material	7 AgNi 90/10, with test button								
	8 AgNi 90/10 hgpp, with test button								
Type of construction	0 Standard, 2.8 mm Faston								
DC coil	006	6 V DC	L06						with LED + diode
	012	12 V DC	L12	AB2					
	024	24 V DC	L24	AC4					
	048	48 V DC	L48	AE8					
	060	60 V DC	L60						
	110	110 V DC	M10	BBO					
	220	220 V DC	N20						
AC coil	506	6 V AC	R06						
	512	12 V AC	R12						
	524	24 V AC	R24						
	548	48 V AC	R48						
	615	115 V AC	S15						
	730	230 V AC	T30						

Industrial relay modules and solid-state relays

B

Ordering data

Input	12 V DC 2CO	24 V DC 2CO	48 V DC 2CO	110 V DC 2CO
Rated control voltage	12 V DC	24 V DC	48 V DC	110 V DC
DC Response/dropout Volt	9.0 V / 1.2 V	18.0 V / 2.4 V	36.0 V / 4.8 V	82.5 V / 11.0 V
Power rating	750 mW	750 mW	750 mW	750 mW
Rated current DC	62.5 mA	31.3 mA	15.6 mA	6.8 mA
Coil resistance	192 Ω ±10 %	777 Ω ±10 %	3072 Ω ±10 %	16133 Ω ±15 %

Ordering data Relay	12 V DC 2CO	24 V DC 2CO	48 V DC 2CO	110 V DC 2CO
Without LED Type	RCM270012	RCM270024	RCM270048	RCM270110
AgNi 90/10 Order No.	8689840000	8689860000	8689880000	8689900000
with LED Type	RCM270L12	RCM270L24	RCM270L48	
AgNi 90/10 Order No.	8689850000	8689870000	8689890000	
With LED + freewheel diode Type	RCM270AB2	RCM270AC4	RCM270AE8	RCM270BBO
AgNi 90/10 Order No.	8957020000	8957030000	8957040000	8957050000
Type Order No.				

Note	12 V DC 2CO	24 V DC 2CO	48 V DC 2CO	110 V DC 2CO

Ordering data

Input	24 V AC 2CO	48 V AC 2CO	115 V AC 2CO	230 V AC 2CO
Rated control voltage	24 V AC	48 V AC	115 V AC	230 V AC
AC Response/dropout Volt	38.4 V / 14.4 V	48.0 V / 18.0 V	92.0 V / 34.5 V	184.0 V / 69.0 V
Power rating	1.0 VA	1.0 VA	1.0 VA	1.0 VA
Rated current AC	41.6 mA	21.3 mA	8.8 mA	4.3 mA
Coil resistance	192 Ω ±10 %	777 Ω ±10 %	4845 Ω ±12 %	19465 Ω ±15 %

Ordering data Relay	24 V AC 2CO	48 V AC 2CO	115 V AC 2CO	230 V AC 2CO
Without LED Type	RCM270524	RCM270548	RCM270615	RCM270730
AgNi 90/10 Order No.	8689760000	8689780000	8689800000	8689820000
with LED Type	RCM270R24	RCM270R48	RCM270S15	RCM270T30
AgNi 90/10 Order No.	8689770000	8689790000	8689810000	8689830000
Type Order No.				
Type Order No.				

Note	24 V AC 2CO	48 V AC 2CO	115 V AC 2CO	230 V AC 2CO

RCM relay

3 CO

AC/DC coil

- 2500 VA switching capacity
- Solder and plug connection
- Safe-to-touch test button, selectable locking
- White labelling panel
- Identification of coils (AC red / DC blue)



Circuit diagram

Dimensions in mm

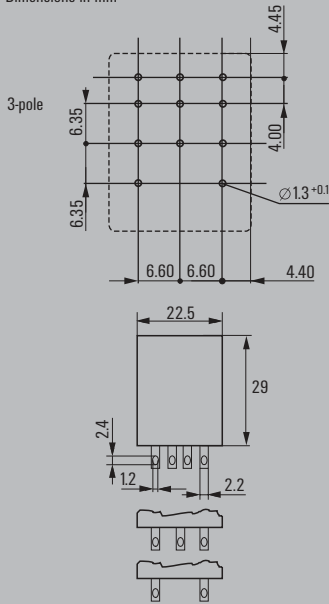

Technical data

Output	
Rated switching voltage	240 V AC
Max. switching voltage, AC	400 V
Continuous current	10 A
Contact material	AgNi 90/10
Mechanical service life	AC coil 20 x 10 ⁶ switch. ops, DC coil 30 x 10 ⁶ switch. cycles
Sparkover time / Drop-out time	15 ms / 10 ms
Rated data	
Ambient temperature (operational)	-40 °C...+70 °C
Flammability class UL94	V-0
Humidity	40 °C / 93 % rel. humidity, no condensation
Approvals	CSA; cURus; VDE
Insulation coordination (EN 50 178)	
Rated voltage	250 V
Clearance and creepage distances for control side - load side	≥ 4 mm
Surge voltage category	
Pollution severity	

Dimensions	Plug-in connection
Length x width x height	mm 28 / 22.5 / 29
Note	

Applications

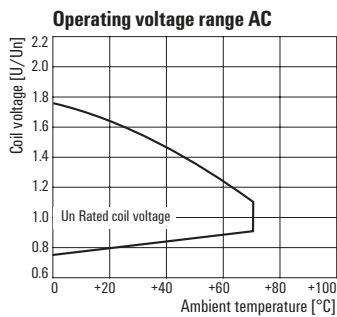
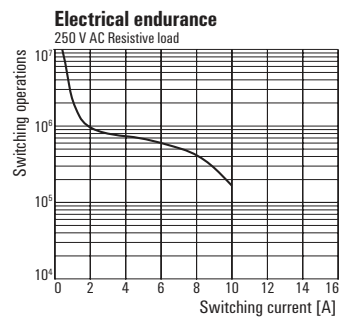
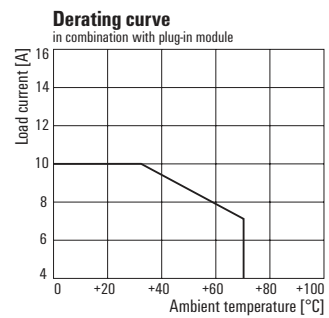
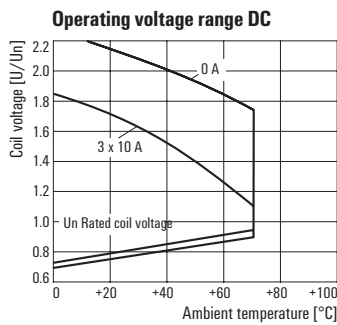
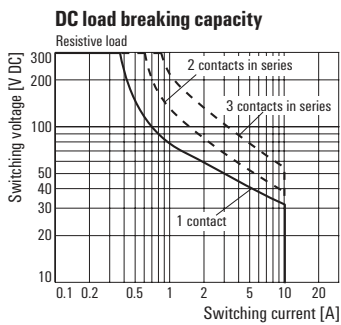

RCM relay
3 CO
AC/DC coil

Type code	RCM							
Type	RIDER Control Multiple							
Contacts	2 2 CO contacts							
	3 3 CO contacts							
	5 4 CO contacts							
Contact material	7 AgNi 90/10, with test button							
	8 AgNi 90/10 hgp, with test button							
Type of construction	0 Standard, 2.8 mm Faston							
DC coil	006 6 V DC							with LED + diode
	012 12 V DC							L06
	024 24 V DC							L12 AB2
	048 48 V DC							L24 AC4
	060 60 V DC							L48 AE8
	110 110 V DC							L60
	220 220 V DC							M10 BBO
AC coil	506 6 V AC							R06
	512 12 V AC							R12
	524 24 V AC							R24
	548 48 V AC							R48
	615 115 V AC							S15
	730 230 V AC							T30

Industrial relay modules and solid-state relays

B

Ordering data

Input	12 V DC 3CO	24 V DC 3CO	48 V DC 3CO	110 V DC 3CO
Rated control voltage	12 V DC	24 V DC	48 V DC	110 V DC
DC Response/dropout Volt	9.0 V / 1.2 V	18.0 V / 2.4 V	36.0 V / 4.8 V	82.5 V / 11.0 V
Power rating	750 mW	750 mW	750 mW	750 mW
Rated current DC	62.5 mA	31.3 mA	15.6 mA	6.8 mA
Coil resistance	192 Ω ±10 %	777 Ω ±10 %	3072 Ω ±10 %	16133 Ω ±15 %

Ordering data Relay	12 V DC 3CO	24 V DC 3CO	48 V DC 3CO	110 V DC 3CO
Without LED Type	RCM370012	RCM370024	RCM370048	RCM370110
AgNi 90/10 Order No.	8690020000	8690040000	8690060000	8690080000
With LED + freewheel diode Type	RCM370AB2	RCM370AC4	RCM370AE8	RCM370BB0
AgNi 90/10 Order No.	8957090000	8957100000	8957110000	8957120000
Type Order No.				
Type Order No.				

Note	12 V DC 3CO	24 V DC 3CO	48 V DC 3CO	110 V DC 3CO

Ordering data

Input	24 V AC 3CO	48 V AC 3CO	115 V AC 3CO	230 V AC 3CO
Rated control voltage	24 V AC	48 V AC	115 V AC	230 V AC
AC Response/dropout Volt	19.2 V / 7.2 V	38.4 V / 14.4 V	92.0 V / 34.5 V	184.0 V / 69.0 V
Power rating	1.0 VA	1.0 VA	1.0 VA	1.0 VA
Rated current AC	41.6 mA	21.3 mA	8.8 mA	4.3 mA
Coil resistance	192 Ω ±10 %	777 Ω ±10 %	4845 Ω ±12 %	19465 Ω ±15 %

Ordering data Relay	24 V AC 3CO	48 V AC 3CO	115 V AC 3CO	230 V AC 3CO
Without LED Type	RCM370524		RCM370615	RCM370730
AgNi 90/10 Order No.	8690030000		8689980000	8690000000
with LED Type	RCM370R24	RCM370R48	RCM370S15	RCM370T30
AgNi 90/10 Order No.	8689950000	8689970000	8689990000	8690010000
Type Order No.				
Type Order No.				

Note	24 V AC 3CO	48 V AC 3CO	115 V AC 3CO	230 V AC 3CO

RCM relay

4 CO

AC/DC coil

- 1500 VA switching capacity
- Solder and plug connection
- AC/DC versions also with gold-plated contacts
- Safe-to-touch test button, selectable locking
- White labelling panel
- Identification of coils (AC red / DC blue)



Technical data

Output	
Rated switching voltage	240 V AC
Max. switching voltage, AC	240 V
Continuous current	6 A
Contact material [print]	AgNi 90/10 or AgNi 5µm Au
Mechanical service life	AC coil 20 x 10 ⁶ switch. ops, DC coil 30 x 10 ⁶ switch. cycles
Sparkover time / Drop-out time	15 ms / 10 ms
Rated data	
Ambient temperature (operational)	-40 °C...+70 °C
Flammability class UL94	V-0
Approvals	CSA; cURus; VDE
Insulation coordination (EN 50 178)	
Rated voltage	250 V
Clearance and creepage distances for control side - load side	≥ 4 mm
Surge voltage category	
Pollution severity	

Circuit diagram

Dimensions in mm

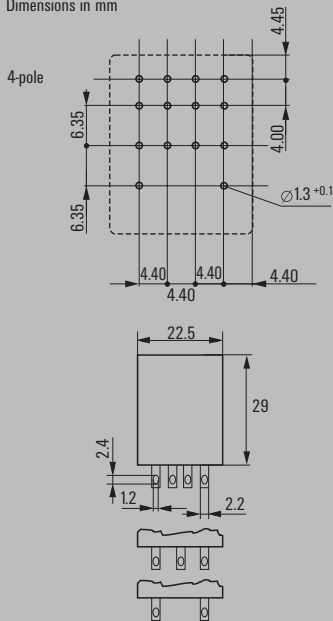

Dimensions	Plug-in connection
Length x width x height	mm 28 / 22.5 / 29
Note	

Applications

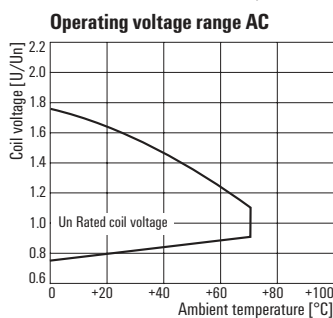
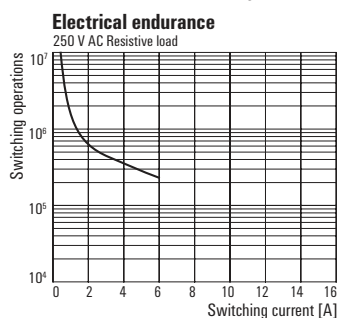
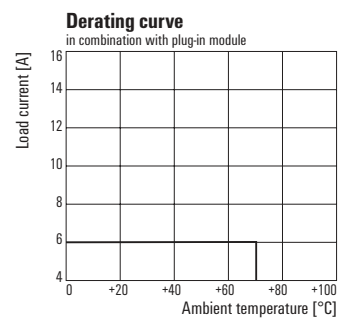
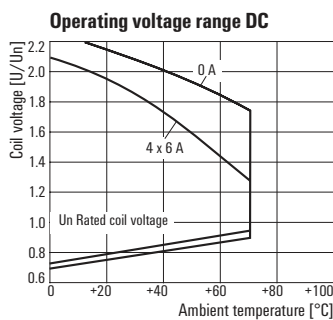
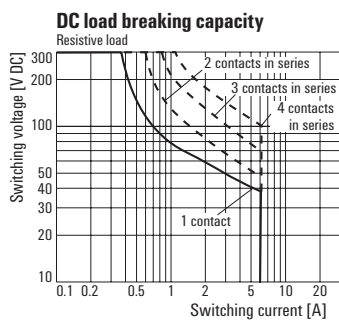

RCM relay

4 CO

AC/DC coil

Type code	RCM				
Type	RIDER Control Multiple				
Contacts	2 2 CO contacts				
	3 3 CO contacts				
	5 4 CO contacts				
Contact material	7 AgNi 90/10, with test button				
	8 AgNi 90/10 hgp, with test button				
Type of construction	0 Standard, 2.8 mm Faston				
DC coil					
006	6 V DC				with LED
012	12 V DC				LED
024	24 V DC				+ diode
048	48 V DC				
060	60 V DC				
110	110 V DC				
220	220 V DC				
AC coil					
506	6 V AC				R06
512	12 V AC				R12
524	24 V AC				R24
548	48 V AC				R48
615	115 V AC				S15
730	230 V AC				T30

Ordering data

Input	12 V DC 4CO	24 V DC 4CO	48 V DC 4CO	110 V DC 4CO
Rated control voltage	12 V DC	24 V DC	48 V DC	110 V DC
DC Response/dropout Volt	9 V / 1.2 V	18 V / 2.4 V	36 V / 4.8 V	82.5 V / 11 V
Power rating	750 mW	750 mW	750 mW	750 mW
Rated current DC	62.5 mA	31.3 mA	15.6 mA	6.8 mA
Coil resistance	192 Ω ±10 %	777 Ω ±10 %	3072 Ω ±10 %	16133 Ω ±15 %

Ordering data Relay				
Without LED Type	RCM570012	RCM570024	RCM570048	RCM570110
AgNi 90/10 Order No.	8054360000	8690200000	8074670000	8074700000
with LED Type	RCM570L12	RCM570L24	RCM570L48	RCM570M10
AgNi 90/10 Order No.	8690180000	8690220000	8690230000	8690240000
Without LED Type	RCM580012	RCM580024	RCM580048	
AgNi 5µm Au Order No.	on request	8694460000	on request	
With LED + freewheel diode Type	RCM570AB2	RCM570AC4	RCM570AE8	RCM570BB0
AgNi 90/10 Order No.	8957160000	8957170000	8957180000	8957190000

Note				

Ordering data

Input	24 V AC 4CO	48 V AC 4CO	115 V AC 4CO	230 V AC 4CO
Rated control voltage	24 V AC	48 V AC	115 V AC	230 V AC
AC Response/dropout Volt	19.2 V / 7.2 V	38.4 V / 14.4 V	92 V / 34.5 V	184 V / 69 V
Power rating	1.0 VA	1.0 VA	1.0 VA	1.0 VA
Rated current AC	41.6 mA	21.3 mA	8.8 mA	4.3 mA
Coil resistance	192 Ω ±10 %	777 Ω ±10 %	4845 Ω ±12 %	19465 Ω ±15 %

Ordering data Relay				
Without LED Type	RCM570524	RCM570548	RCM570615	RCM570730
AgNi 90/10 Order No.	8690110000	1180900000	1180800000	1181100000
with LED Type	RCM570R24	RCM570R48	RCM570S15	RCM570T30
AgNi 90/10 Order No.	8690120000	8690130000	8690150000	8690160000
Without LED Type	RCM580524		RCM580615	RCM580730
AgNi 5µm Au Order No.	7940008171		8824860000	7940007637
Type Order No.				

Note				

RRD relay

2 CO

AC/DC coil

- 2 CO contacts
- 2500 VA switching capacity
- Mechanical operating display
- Safe-to-touch test button, selectable locking



Technical data

Output	
Max. switching voltage, AC	400 V
Continuous current	10 A
Contact material	AgNi 90/10
Mechanical service life	20 x 10 ⁸ switching cycles
Sparkover time / Drop-out time	15 ms / 10 ms
Rated data	
Status indicator / Free-wheel diode	Mechanical / No
Ambient temperature (operational)	-40 °C...+60 °C
Flammability class UL94	V-0
Humidity	40 °C / 93 % rel. humidity, no condensation
Approvals	CSA; cURus; VDE
Insulation coordination (EN 50 178)	
Rated voltage	250 V
Clearance and creepage distances for control side - load side	≤ 3 mm
Surge voltage category	
Pollution severity	

Circuit diagram

View of connections

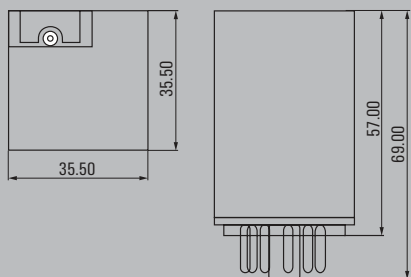
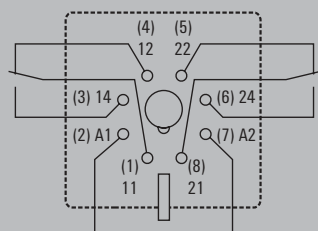

Dimensions	Plug-in connection
Length x width x height	mm 35.5 / 35.5 / 57
Note	

Applications

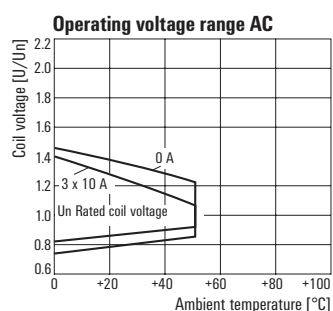
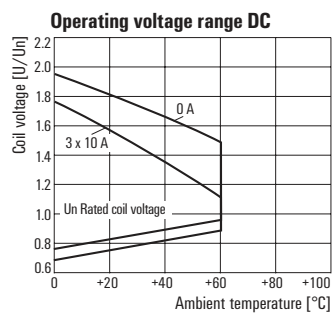
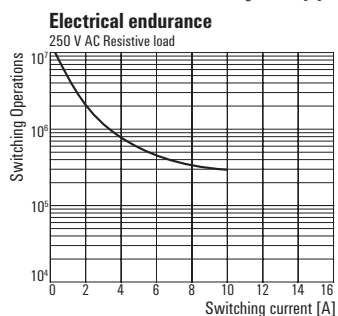
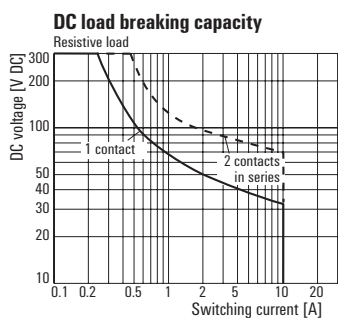

RRD relay
2 CO
AC/DC coil

Type code	RRD					
Type	RIDER Round					
Contacts	2 2 change-over contacts, 8-pole 3 3 change-over contacts, 11-pole					
Contact material	2 AgNi 90/10					
Type of construction	1 DC coil with test button 3 DC coil with test button and bi-polar LED 6 AC coil with test button 8 AC coil with test button and bi-polar LED					
DC coil	006	6 V DC				
	012	12 V DC				
	024	24 V DC				
	048	48 V DC				OC4
	060	60 V DC				OE8
	110	110 V DC				OB0
	220	220 V DC				OC0
AC coil	006	6 V AC				
	012	12 V AC				
	024	24 V AC				
	048	48 V AC				
	115	115 V AC				
	230	230 V AC				

Free wheel diode

Ordering data

Input	24 V DC 2CO	48 V DC 2CO	24 V AC 2CO	48 V AC 2CO
Rated control voltage	24 V DC	48 V DC	24 V AC	48 V AC
DC Response/dropout Volt	18.0 V / 2.4 V	36.0 V / 4.8 V	19.2 V / 9.6 V	38.4 V / 19.2 V
Power rating	1.2 W	1.2 W	2.3 VA	2.3 VA
Rated current DC	50.5 mA	24.0 mA	94.2 mA	47.5 mA
Coil resistance	475 Ω ±10 %	2000 Ω ±10 %	86 Ω ±10 %	345 Ω ±10 %

Ordering data Relay				
w. test button Type	RRD221024		RRD226024	
AgNi 90/10 Order No.	8690370000		8690270000	
With test button + LED Type	RRD223024	RRD223048	RRD228024	RRD228048
AgNi 90/10 Order No.	8690380000	8690400000	8690280000	8690300000
Type				
Order No.				
Type				
Order No.				

Note				

Ordering data

Input	115 V AC 2CO	230 V AC 2CO
Rated control voltage	115 V AC	230 V AC
AC Response/dropout Volt	92.0 V / 34.5 V	184.0 V / 92.0 V
Power rating	2.3 VA	2.3 VA
Rated current AC	20.6 mA	10.1 mA
Coil resistance	2000 Ω ±10 %	8300 Ω ±12 %

Ordering data Relay		
w. test button Type	RRD226115	RRD226230
AgNi 90/10 Order No.	8690310000	8690330000
With test button + LED Type	RRD228115	RRD228230
AgNi 90/10 Order No.	8690320000	8690340000
Type		
Order No.		
Type		
Order No.		

Note		

Industrial relay modules and solid-state relays

B

RRD relay

3 CO

AC/DC coil

- 3 CO contacts
- 500 VA switching capacity
- Mechanical operating display
- Safe-to-touch test button, selectable locking



Technical data

Output	
Max. switching voltage, AC	400 V
Continuous current	10 A
Contact material	AgNi 90/10
Mechanical service life	20 x 10 ⁶ switching cycles
Sparkover time / Drop-out time	12 ms / 5 ms
Rated data	
Status indicator / Free-wheel diode	Mechanical / No
Ambient temperature (operational)	DC coil: -45 °C...+60 °C / AC coil: -45 °C...+50 °C
Flammability class UL94	V-0
Humidity	40 °C / 93 % rel. humidity, no condensation
Approvals	CSA; cURus; VDE
Insulation coordination (EN 50 178)	
Rated voltage	250 V
Clearance and creepage distances for control side - load side	3 mm
Surge voltage category	
Pollution severity	

Dimensions	Plug-in connection
Length x width x height	35.5 / 35.5 / 57
Note	

Circuit diagram

View of connections

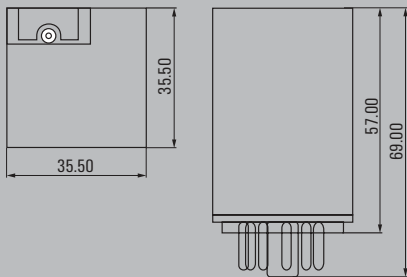
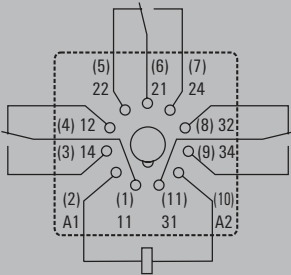

Applications

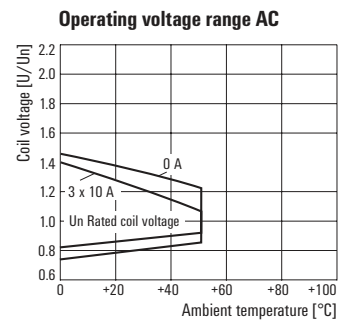
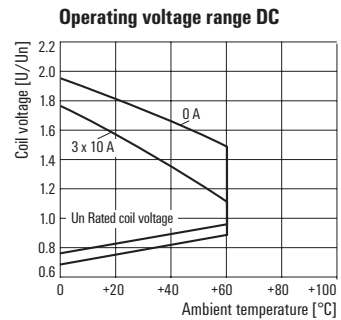
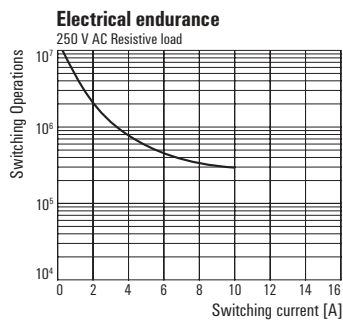
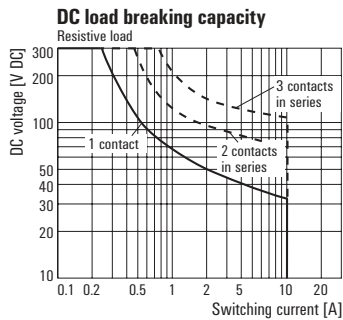

RRD relay
3 CO
AC/DC coil

Type code	RRD				
Type	RIDER Round				
Contacts	2 2 change-over contacts, 8-pole 3 3 change-over contacts, 11-pole				
Contact material	2 AgNi 90/10				
Type of construction	1 DC coil with test button 3 DC coil with test button and bi-polar LED 6 AC coil with test button 8 AC coil with test button and bi-polar LED				
DC coil	006	6 V DC			
	012	12 V DC			
	024	24 V DC			
	048	48 V DC			OC4
	060	60 V DC			OE8
	110	110 V DC			1B0
	220	220 V DC			2CO
AC coil	006	6 V AC			
	012	12 V AC			
	024	24 V AC			
	048	48 V AC			
	115	115 V AC			
	230	230 V AC			

Ordering data

Input	12 V DC 3CO	24 V DC 3CO	110 V DC 3CO	220 V DC 3CO
Rated control voltage	12 V DC	24 V DC	110 V DC	220 V DC
DC Response/dropout Volt	9 V / 1.2 V	18 V / 2.4 V	82.5 V / 11.5 V	165 V / 22 V
Power rating	1.2 W	1.2 W	1.2 W	1.2 W
Rated current DC	109.1 mA	50.5 mA	11 mA	5.5 mA
Coil resistance	110 Ω ±10 %	475 Ω ±10 %	10000 Ω ±12 %	40000 Ω ±15 %

Ordering data Relay				
w. test button	Type	RRD321012	RRD321024	RRD321110
	Order No.	8799030000	8690610000	8690650000
With test button + LED	Type		RRD323024	RRD323110
	Order No.		8690620000	8690660000
w. test button	Type		RRD3210C4	RRD3211B0
+ Free-wheel diode	Order No.		8797650000	8797640000
With test button + LED	Type		RRD3230C4	RRD3232C0
+ Free-wheel diode	Order No.		7940007732	8829400000

Note				

Ordering data

Input	24 V AC 3CO	48 V AC 3CO	115 V AC 3CO	230 V AC 3CO
Rated control voltage	24 V AC	48 V AC	115 V AC	230 V AC
AC Response/dropout Volt	19.2 V / 7.2 V	38.4 V / 14.4 V	92 V / 34.5 V	184 V / 92 V
Power rating	2.3 VA	2.3 VA	2.3 VA	2.3 VA
Rated current AC	94.2 mA	47.5 mA	20.6 mA	10.1 mA
Coil resistance	86 Ω ±10 %	345 Ω ±10 %	2000 Ω ±10 %	8300 Ω ±12 %

Ordering data Relay				
w. test button	Type	RRD326024	RRD326048	RRD326115
	Order No.	8690450000	8690470000	8690550000
With test button + LED	Type	RRD328024	RRD328048	RRD328115
	Order No.	8690460000	8690480000	8690560000
	Type			
	Order No.			
	Type			
	Order No.			

Note				

Accessories for RRD relay modules

Plug-in module with screw connection



Dimensions in mm

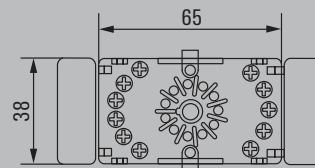
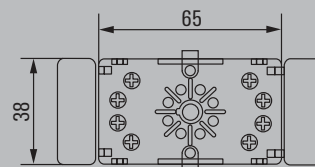
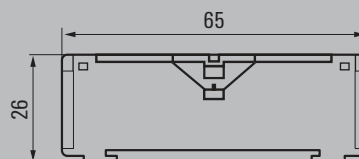

Technical data

Contact data	
Nominal current	10 A
Nominal voltage	400 V AC
Dielectric strength, coil/contacts	>2500 V _{eff}
Ambient temperature	-20 °C ... + 80 °C
Ingress protection class (IEC 61810)	IP 20
Approvals	cURus
Connection cross-section / with ferrule	2 x 2.5 mm ² / 2 x 1.5 mm ²
Terminal torque	0.5 / 0.7 Nm
Humidity	40 °C/93 rel. humidity, no condensation

Ordering data

Description	Type	Qty.	Order No.
Plug-in module with screw connections, 8-pole	SRD-I 2CO	10	8869360000
Plug-in module with screw connections, 11-pole	SRD-I 3CO	10	8869350000

Accessories

Description	Type	Order No.
End bracket	WEW 35/2	1061200000
Screwdriver	SD 0.6/3.5/100	9008330000
Metal retaining clip, RRD	SRD-I CLIP M	8869370000

RPW relay

2 CO AC/DC coil

3 CO AC/DC coil

- 6000 VA switching capacity
- Mechanical operating display
- With and without test button



Industrial relay modules and solid-state relays

B

Circuit diagram

View of connections

2 changeover contacts

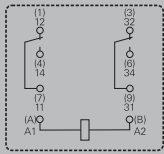

3 changeover contacts

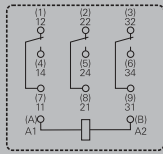

Cap without lug, plug-in connections

Cap with fixing lug, 6.3 mm Faston (4.8 mm possible)

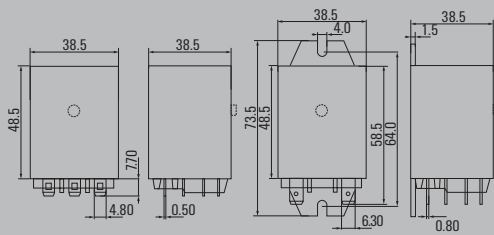

Technical data

Output	
Max. switching voltage, AC	440 V
Continuous current	16 A
Contact material	AgCdO
Mechanical service life	20 x 10 ⁸ switching cycles
Sparkover time / Drop-out time	15 ms / 10 ms
Rated data	
Status indicator / Free-wheel diode	Mechanical / No
Ambient temperature (operational)	-45 °C...+70 °C
Flammability class UL94	V-0
Humidity	40 °C / 93 % rel. humidity, no condensation
Approvals	CSA; cURus; VDE
Insulation coordination (EN 50 178)	
Rated voltage	250 V
Clearance and creepage distances for control side - load side	≥ 4 mm
Surge voltage category	
Pollution severity	

Dimensions	Plug-in connection
Length x width x height	mm 38.5 / 38.5 / 48.5
Note	

Applications

DC load breaking capacity

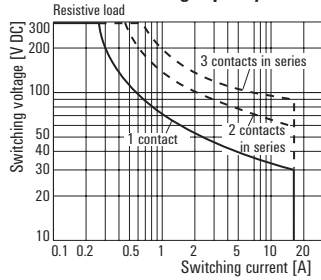

Electrical endurance

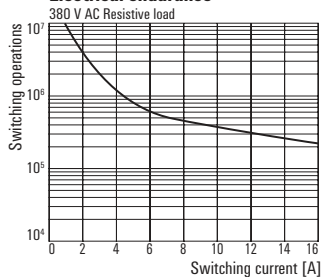

Operating voltage range DC

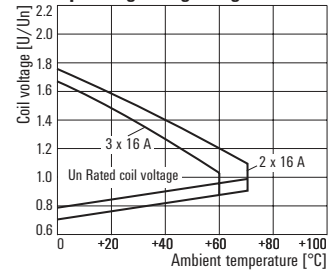

Operating voltage range AC

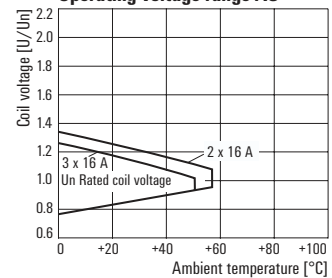

RPW relay
2 CO AC/DC coil
3 CO AC/DC coil

Type code		RPW				
Typ	RIDER PoWer					
Contacts	2 2 change-over contacts 7 3 change-over contacts					
Type of construction						
0 Without test button						
3 With test button						
Housing						
2 Cap without lug, 4.8 mm Faston						
5 Cap with lug, 6.3 mm Faston						
DC coil						
006 6 V DC						
012 12 V DC						
024 24 V DC						
048 48 V DC						
060 60 V DC						
110 110 V DC						
AC coil						
506 6 V AC						
512 12 V AC						
524 24 V AC						
548 48 V AC						
615 115 V AC						
730 230 V AC						

Ordering data

Input	24 V DC 2CO	24 V AC 2CO	230 V AC 2CO
Rated control voltage	24 V DC	24 V AC	230 V AC
DC Response/dropout Volt	18 V / 2.4 V		
AC Response/dropout Volt		19.2 V / 9.6 V	184 V / 69 V
Power rating	1.2 W	2.3 VA	2.3 VA
Rated current DC	50.5 mA		
Rated current AC		94.2 mA	10.1 mA
Coil resistance	475 Ω ±10 %	86 Ω ±10 %	8300 Ω ±12 %

Ordering data Relay	24 V DC 2CO	24 V AC 2CO	230 V AC 2CO
w.o. test button Type	RPW202024	RPW202524	RPW202730
AgCd0 Order No.	8690730000	on request	8690720000
Type Order No.			
Type Order No.			
Type Order No.			
Type Order No.			

Note	24 V DC 2CO	24 V AC 2CO	230 V AC 2CO

Ordering data

Input	24 V DC 3CO	24 V AC 3CO	230 V AC 3CO
Rated control voltage	24 V DC	24 V AC	230 V AC
DC Response/dropout Volt	18 V / 2.4 V		
AC Response/dropout Volt		19.2 V / 7.2 V	184 V / 69 V
Power rating	1.6 W	2.8 VA	2.8 VA
Rated current DC	69.6 mA		
Rated current AC		109.2 mA	11.7 mA
Coil resistance	345 Ω ±10 %	80 Ω ±10 %	7500 Ω ±10 %

Ordering data Relay	24 V DC 3CO	24 V AC 3CO	230 V AC 3CO
w.o. test button Type	RPW702024	RPW702524	RPW702730
AgCd0 Order No.	8690760000	8690740000	8690750000
Type Order No.			
Type Order No.			
Type Order No.			
Type Order No.			

Note	24 V DC 3CO	24 V AC 3CO	230 V AC 3CO

Accessories for RPW

Plug-in module with screw connection

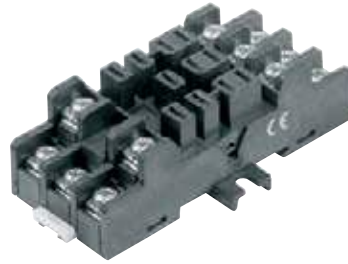

Dimensions in mm

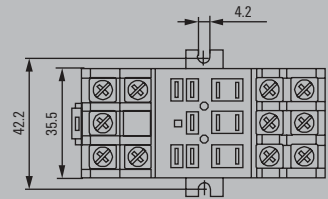
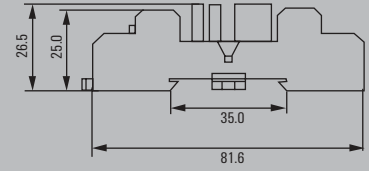

Technical data

Contact data	
Nominal current	16 A
Nominal voltage	250 V AC
Dielectric strength, coil/contacts	>2500 Vms
Ambient temperature (operational)	-40 °C ... +40 °C
Terminal torque	0.8 Nm
max.	1.2 Nm
Humidity	40 °C/93 rel. humidity, no condensation

Ordering data

Description	Type	Qty.	Order No.
Plug-in module with screw connections	SPW 3C0	25	8697680000

Accessories

Description	Type	Order No.
End bracket	WEW 35/2	1061200000
Screwdriver	SD 0,6/3,5/100	9008330000

Signal monitoring in safety-critical circuits

Coupling relays with positively driven contacts

Weidmüller has expanded the RIDERSERIES to include a relay variant with force-guided contacts. Relays with force-guided contacts have a 99 % diagnostics coverage and an excellent reputation for use in safety systems. The contacts interlock mechanically with each other in order to ensure a synchronous switching status of both contacts. This guarantees that the alert contact will maintain the same switching status in the event of an error (for example, if the working contact melts from an overload). The controller (or safety controller) detects the alert contact and then compares the set point and actual values. If a difference occurs, measures can then be taken to protect equipment and human life.

Resistant to vibration

A metal clip ensures that the relay module remains secure even under vibration / mechanical shock conditions.

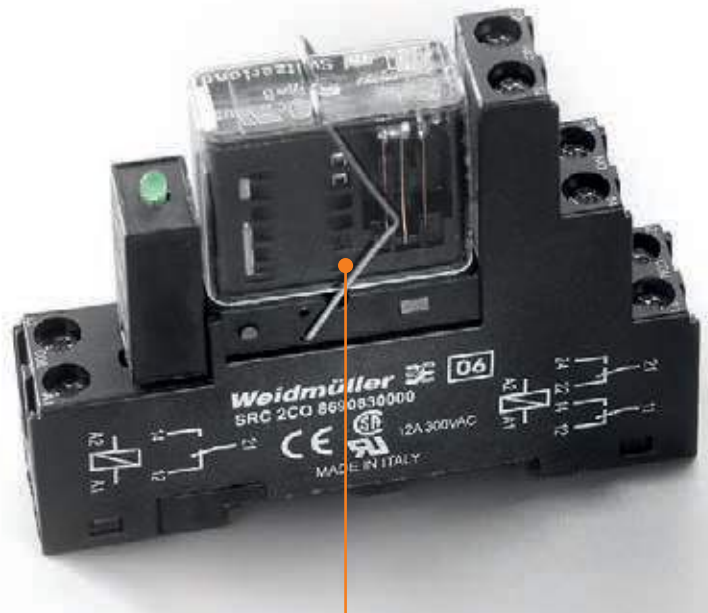

A variety of connection options

The base is available either with the proven screw clamp connection or the time saving tension clamp connection.



Convenient

Relay modules can be replaced quickly in the event of a fault without removing the connecting cable.



On site diagnostics

An easy to view LED display module with an integrated free wheeling diode is used to protect the series connected electronics.

Safety-based output relay controls

By connecting two coupling relays together with a safety based controller or safety switching devices, it is possible to set up a safe and efficient control mechanism that complies with the structure specified in EN ISO 13849-1 (Category 3 and 4).

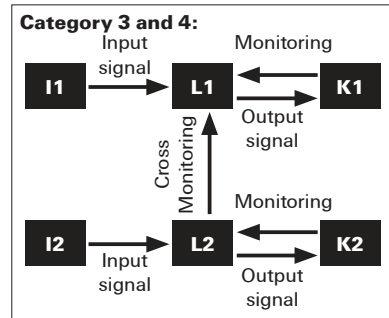

RCI KIT with forcibly guided contacts

2 CO

DC coil

Modular system comprising:

- Relay socket for rail mounting
- LED indicator unit
- Retaining clip
- Pluggable relay modules
- Markers



Technical data

Output	
Max. switching voltage, AC	250 V
Continuous current	6 A
Contact material	AgCuNi
Mechanical service life	> 50 x 10 ⁶ switching cycles
Sparkover time / Drop-out time	12 ms / 5 ms
Rated data	
Status indicator / Free-wheel diode	Green LED / Yes
Ambient temperature (operational)	-40 °C...+70 °C
Flammability class UL94	V-1
Humidity	40 °C / 95 % rel. humidity, no condensation
Approvals	CE
Insulation coordination (EN 50 178)	
Rated voltage	250 V
Clearance and creepage distances for control side - load side	≥ 10 mm
Surge voltage category	III
Pollution severity	3
Standards	DIN EN 50205

Dimensions	Screw connection	Tension clamp connection
Length x width x height	mm 78.5 / 15.5 / 62	96.9 / 16 / 63.2
Note		

DC-Version

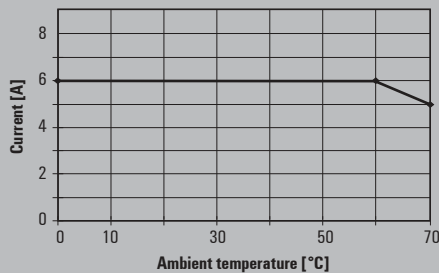
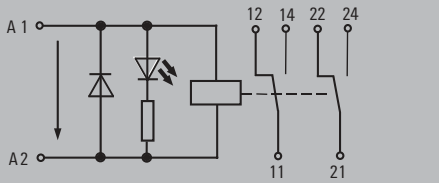

Ordering data

Input	
Rated control voltage	24 V DC
Rated current DC	40 mA
Power rating	0.82 W
DC Response/dropout Volt	16.8 V / 2.4 V

24 V DC 2CO LED

Ordering data	
Screw connection	Type RCIKIT 24VDC 2CO LD/FG
	Order No. 1218410000
Tension clamp connection	Type RCIKITZ 24VDC 2CO LD/FG
	Order No. 1218390000

Ordering data	
Spare relay	Type RCI42424FG
	Order No. 1218380000

Note	

1 NCC, 1 NOC

or 1 change-over contact

RS 30

Screw connection

1 NOC
1 NCC



1 change-over
contact



RS 30

Isolating plug with screw connection

1 NOC
1 NCC



1 change-over
contact



Technical data

Input voltage

5...60 V ± 10 %; 115 V/230 V + 5 % - 15 %

Nominal consumption - (W)

Nominal consumption ~ (VA)

Drop-out current of relay module (at 20 °C)

Drop-out current of relay module (at 20 °C)

Pick-up current

Output voltage max.

Continuous current

Derating curve

a = fitted on mounting rail in horizontal row without spacing

b = fitted on mounting rail in horizontal row with 20 mm spacing

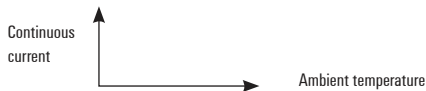

5 VTTL	24 V-	24 V=	115 V~	230 V~
0.45 W ¹⁾	0.45 W	0.45 W	-	-
-	-	0.7 VA	0.8 VA	0.8 VA
-	3 mA	2.5 mA~	-	-
-	-	3.5 mA~	1 mA~	1 mA~
-	12 mA	-	6 mA	-
250 V	250 V	250 V	250 V	250 V
5 A	6 A	6 A	5 A	3 A

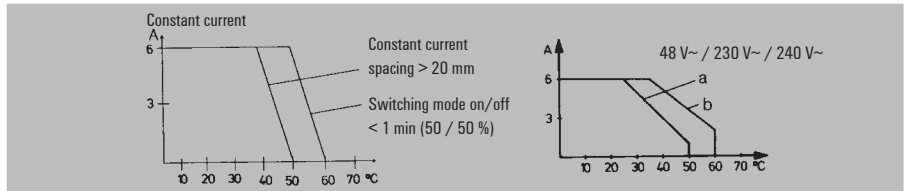

Making current

Making power under ohmic load

Min. switching power/switching current

Duration of bounce

Typical switching times

- Pick-up delay

- Drop-out delay

Max. switching frequency

Contact material

Service life, mechanical

- 24 V-, 1 A, ohmic load

- 230 V~, 3 A, ohmic load

Storage temperature

Ambient temperature, fitted on mounting rail

- in horizontal row without spacing

- in horizontal row without spacing ≥ 20 mm spacing

Humidity

Insulation coordination to EN 50178

Surge category

Pollution severity

Dimensions

Mounting width

Length (at 90° to mounting rail)

Height (with TS 32 / TS 35 x 7.5)

8 A

2000 VA / 100 W

250 mW / 10 mA

≤ 3 ms

≤ 8 ms

≤ 7 ms

70 Hz

AgNi, gold-flashed

>10⁷ switching cycles

> 5 x 10⁵ switching cycles

>7 x 10⁵ switching cycles

-40 °C...+60 °C

-25 °C...+40 °C

-25 °C...+50 °C

40 °C/93 rel. humidity, no condensation

III

2

11.2 mm NOC / NCC, 25 mm change-over contact

70 mm (74 mm BL/SL version)

56 mm / 51.5 mm

1) Rated consumption of auxiliary voltage 24 V-.

RS 30

Screw connection

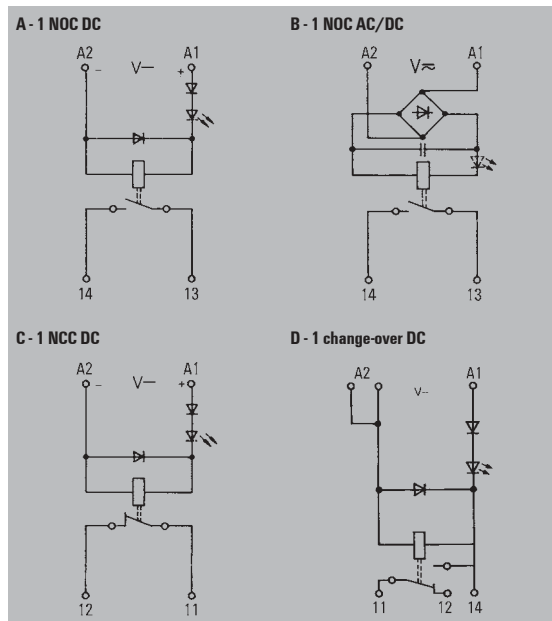

RS 30

Isolating plug with screw connection

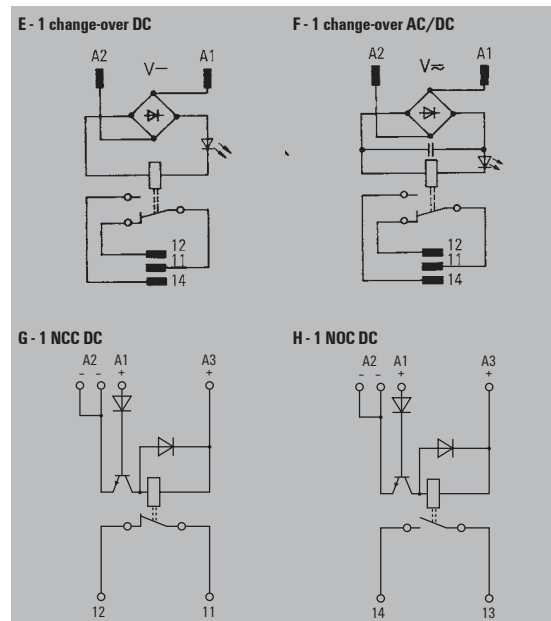

Ordering data

Wiring diagram	
Input voltage	Function indicator
5 V-, TTL	without
24 V-	without
	LED green
	LED red
24 V=	without
	LED green
	LED red
115 V~	without
	LED green
	LED red
230 V~	without
	LED green
	LED red

A	B	C	D
NOC	NOC	NCC	change-over
1101661001		1100961001	
1101611001		1100911001	1181511001
1101621001		1100921001	1181521001
	1101711001		
	1101721001		
	1102111001		
	1102121001		
	1102261001		
	1102211001		
	1102221001		

E	F	G	H
change-over	change-over	NCC	NOC
		1167660000	1167760000
1100260000			
1100210000			
1100220000			
	1100360000		
	1100760000		
	1100860000		

1 CO contact

AC/DC coil

- For high switching capacities
- Suitable for switching inductive loads



Industrial relay modules and solid-state relays

B

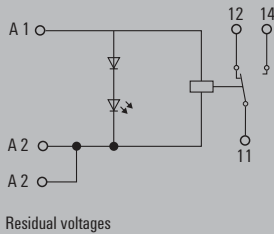
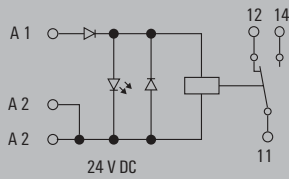

Technical data

Output	
Max. switching voltage, AC / Continuous current	250 V / 16 A
Min. switching power	1 W
Sparkover time / Drop-out time	
Contact material	AgCdO
Mechanical service life	3 x 10 ⁷ switching cycles
Max. switching frequency at rated load	0.1 Hz
Rated data	
Status indicator / Free-wheel diode	red LED / Yes
Reverse polarity protection	Available
Ambient temperature (operational)	-25 °C...+40 °C
Storage temperature	-40 °C...+60 °C
Humidity	40 °C / 93 % rel. humidity, no condensation
Approvals	CE
Insulation coordination (EN 50 178)	
Standards	DIN EN 50178
Rated voltage	250 V
Impulse withstand voltage	6 kV
Clearance and creepage distances for control side - load side	> 3 mm
Surge voltage category	III
Pollution severity	2

Dimensions	Screw connection
Clamping range (nominal / min. / max.)	mm ² 2.5 / 0.5 / 4
Length x width x height	mm 53.5 / 25 / 70

Note

Ordering data

Input	24 V DC 1CO	115 V AC 1CO	230 V AC 1CO
Rated control voltage	24 V DC ±10 %	115 V AC +5 % / -15 %	230 V AC +5 % / -15 %
Rated current AC		8 mA	4.5 mA
Rated current DC	40 mA		
Power rating	1 W	1 VA	1 VA
AC Response/dropout Volt		98 V	195 V
DC Response/dropout Volt	21.5 V		
AC pickup/dropout current		-/1.5 mA	-/2.2 mA
DC pickup/dropout current	-/11.5 mA		

Ordering data		24 V DC 1CO	115 V AC 1CO	230 V AC 1CO
Screw connection	Type	RS 31 24VDC LD LP 1U	RS 31 115VAC LD LP 1U	RS 31 230VAC LD LP 1U
	Order No.	1128361001	1150461001	1128461001
	Type			
	Order No.			

Note

2 CO contacts**positively-driven contacts**

- DC coil
- Relay module with 2 positively-driven CO contacts, acc. to EN 50205
- 2-pole safety relays with 2 CO contacts*)
- For mounting on TS 32/35

**Technical data**

Output	
Max. switching voltage, AC / Continuous current	250 V / 4 A
Min. switching power	5 V / 10 mA
Sparkover time / Drop-out time	
Contact material	AgNi 90/10
Mechanical service life	20 x 10 ⁶ switching cycles
Max. switching frequency at rated load	0.1 Hz
Rated data	
Status indicator / Free-wheel diode	red LED / No
Reverse polarity protection	Yes
Ambient temperature (operational)	-25 °C...+40 °C
Storage temperature	-40 °C...+85 °C
Humidity	40 °C / 93 % rel. humidity, no condensation
Approvals	CE
Insulation coordination (EN 50 178)	
Standards	DIN EN 50178, DIN EN 50205
Rated voltage	300 V
Impulse withstand voltage	4 kV
Clearance and creepage distances for control side - load side	≥ 4 mm
Surge voltage category	III
Pollution severity	2

Dimensions	Screw connection	
Clamping range (nominal / min. / max.)	mm ²	2.5 / 0.5 / 4
Length x width x height	mm	63.5 / 25 / 70
Note	*) According to EN50205, only 1 NO / 1 NC is permitted for safety circuits	

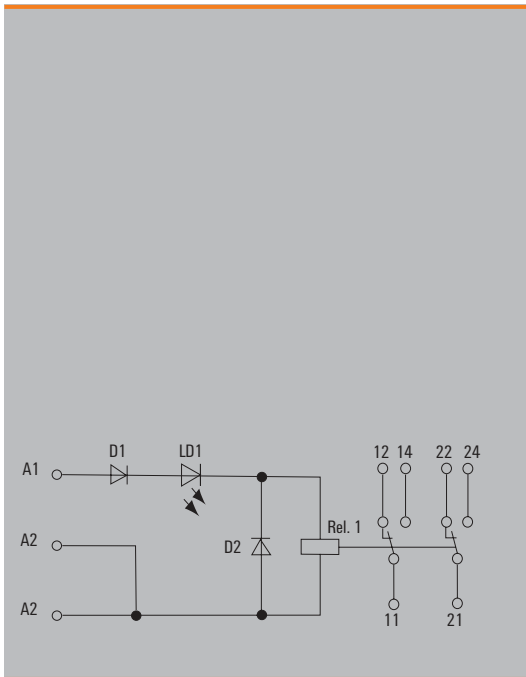
**Ordering data**

Input	24 V DC 2CO
Rated control voltage	24 V DC ±10 %
Rated current AC	
Rated current DC	21 mA
Power rating	0.5 W
AC Response/dropout Volt	
DC Response/dropout Volt	16 V / 10 V
AC pickup/dropout current	
DC pickup/dropout current	12.5 mA / 7 mA

Ordering data

Type	RS32 24 VDC SAFETY
Order No.	8872160000
Type	
Order No.	

Note

2 CO contacts

DC coil

- Relay modules with two CO contacts
- Relay soldered
- Optional multi-voltage input
- For mounting on TS 32/35

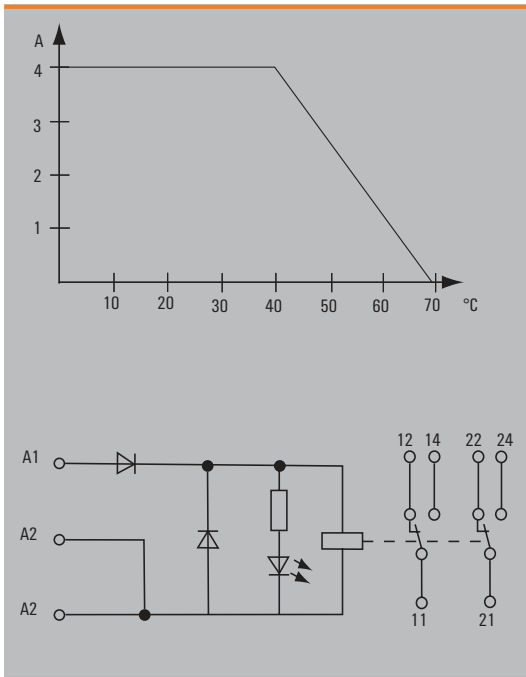

Technical data

Output	
Max. switching voltage, AC / Continuous current	250 V / 4 A
Min. switching power	10 V / 10 mA
Sparkover time / Drop-out time	
Contact material	AgNi 90/10
Mechanical service life	3 x 10 ⁷ switching cycles
Max. switching frequency at rated load	0.1 Hz
Rated data	
Status indicator / Free-wheel diode	red LED / Yes
Reverse polarity protection	Available
Ambient temperature (operational)	-25 °C...+40 °C
Storage temperature	-40 °C...+60 °C
Humidity	40 °C / 93 % rel. humidity, no condensation
Approvals	CE
Insulation coordination (EN 50 178)	
Standards	DIN EN 50178
Rated voltage	250 V
Impulse withstand voltage	4 kV
Clearance and creepage distances for control side - load side	> 3 mm
Surge voltage category	III
Pollution severity	2

Dimensions	Screw connection
Clamping range (nominal / min. / max.)	mm ² 2.5 / 0.5 / 4
Length x width x height	mm 63.5 / 25 / 70

Note

Ordering data

Input	24 V DC 2CO
Rated control voltage	24 V DC ±10 %
Rated current AC	
Rated current DC	25 mA
Power rating	0.6 W
AC Response/dropout Volt	
DC Response/dropout Volt	21.5 V
AC pickup/dropout current	
DC pickup/dropout current	-/5 mA

Ordering data	
Screw connection	Type RS 32 24VDC LD LP 2U
	Order No. 9406121001
	Type
	Order No.

Note

2 CO contacts
UC coil

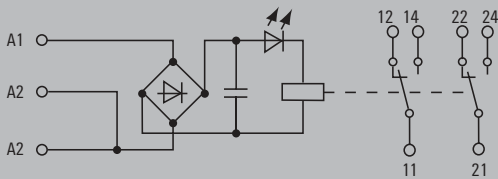
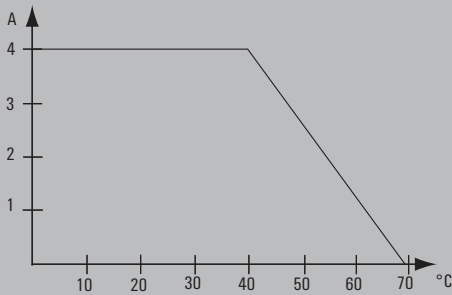

Technical data

Output	
Max. switching voltage, AC / Continuous current	250 V / 4 A
Min. switching power	12 V / 10 mA
Sparkover time / Drop-out time	
Contact material	AgNi 90/10
Mechanical service life	30 x 10 ⁷ switching cycles
Max. switching frequency at rated load	0.1 Hz
Rated data	
Status indicator / Free-wheel diode	red LED / No
Reverse polarity protection	Available
Ambient temperature (operational)	-25 °C...+40 °C
Storage temperature	-40 °C...+60 °C
Humidity	40 °C / 93 % rel. humidity, no condensation
Approvals	CE; CSA; MARITREG; ROHS
Insulation coordination (EN 50 178)	
Standards	DIN EN 50178
Rated voltage	250 V
Impulse withstand voltage	4 kV
Clearance and creepage distances for control side - load side	> 3 mm
Surge voltage category	III
Pollution severity	2

Dimensions	Screw connection
Clamping range (nominal / min. / max.)	mm ² 2.5 / 0.5 / 4
Length x width x height	mm 63.5 / 25 / 70

Note

Ordering data

Input	24 V UC 2CO	115 V UC 2CO	230 V UC 2CO
Rated control voltage	24 V UC ±10 %	115 V UC +5 % / -15 %	230 V UC +5 % / -15 %
Rated current AC	28 mA	5 mA	4.3 mA
Rated current DC	18 mA	5 mA	4.3 mA
Power rating	0.6 W / 0.9 VA	0.5W / 0.6VA	1 W / 1 VA
AC Response/dropout Volt			
DC Response/dropout Volt	21.5 V	98 V	195 V
AC pickup/dropout current	-/2.5 mA	-/1.5 mA	-/2 mA
DC pickup/dropout current	-/4.5 mA	1 mA	-/1.2 mA

Ordering data		24 V UC 2CO	115 V UC 2CO	230 V UC 2CO
Screw connection	Type	RS 32 24VUC LD LP 2U	RS 32 115VUC LD LP 2U	RS 32 230VUC LD LP 2U
	Order No.	9406221001	9406621001	9406721001
	Type			
	Order No.			

Note

2 CO contacts
multiple voltage input



Industrial relay modules and solid-state relays

B

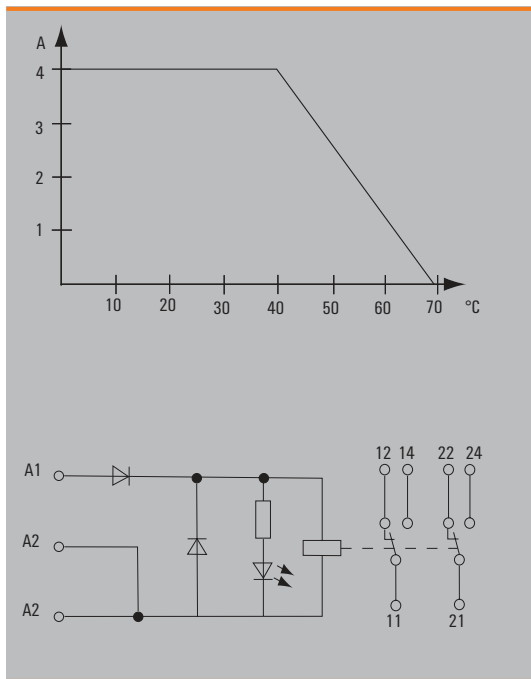

Technical data

Output	
Max. switching voltage, AC / Continuous current	250 V / 4 A
Min. switching power	10 V / 10 mA
Sparkover time / Drop-out time	13 ms / 10 ms
Contact material	AgNi 90/10
Mechanical service life	30 x 10 ⁷ switching cycles
Max. switching frequency at rated load	0.1 Hz
Rated data	
Status indicator / Free-wheel diode	red LED / No
Reverse polarity protection	Available
Ambient temperature (operational)	-25 °C...+40 °C
Storage temperature	-40 °C...+60 °C
Humidity	40 °C / 93 % rel. humidity, no condensation
Approvals	CE
Insulation coordination (EN 50 178)	
Standards	DIN EN 50178
Rated voltage	250 V
Impulse withstand voltage	4 kV
Clearance and creepage distances for control side - load side	> 3 mm
Surge voltage category	III
Pollution severity	2

Dimensions	Screw connection
Clamping range (nominal / min. / max.)	mm ² 2.5 / 0.5 / 4
Length x width x height	mm 63.5 / 25 / 70

Note

Ordering data

Input	24-48 V UC 2CO
Rated control voltage	24 V UC ±10 %, 48 V UC ±10 %
Rated current AC	28 mA / 22 mA
Rated current DC	18 mA / 20 mA
Power rating	0.6 W / 0.9 VA
AC Response/dropout Volt	
DC Response/dropout Volt	21.5 V / 43 V
AC pickup/dropout current	3 mA / 4.5 mA
DC pickup/dropout current	5 mA / 2 mA

115-230 V UC 2CO
115 V UC +5 % / -15 %, 230 V UC +5 % / -15 %
5.6 mA / 5.3 mA
5.4 mA / 5 mA
1 W / 1 VA
98 V / 195 V
1.5 mA / 2 mA
1 mA / 1.2 mA

Ordering data	
Screw connection	Type
	Order No.
	Type
	Order No.

RS 32 24-48VUC LD LP 2U
1122661001

RS 32 115-230VUC LD 2U
1122761001

Note

4-/8-/16-way, ea. with 1 COC

RSM 4 R / RSM 4 RS

4 relay modules
soldered or plug-in

RSM 8 R / RSM 8 RS

8 relay modules
soldered or plug-in

RSM 16 R / RSM 16 RS

16 relay modules
soldered or plug-in

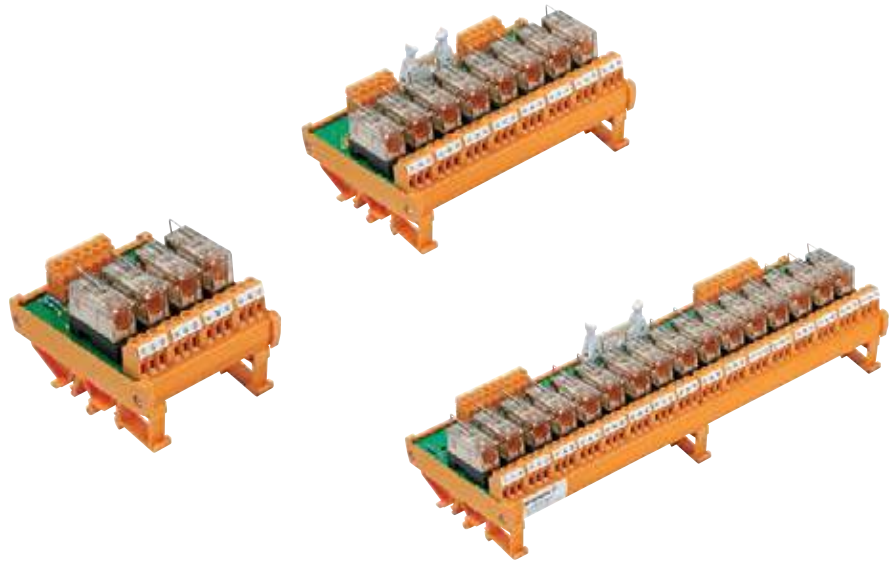

Technical data

Rated data	
Input voltage	
Nominal consumption DC	soldered relay module plug-in relay module
Nominal consumption AC	soldered relay module plug-in relay module
Pick-up current DC	soldered relay module plug-in relay module
Pick-up current AC	soldered relay module plug-in relay module

Drop-out current of relay module (at 20 °C)	
Output voltage max.	250 V
Continuous current	6 A

Derating curve
a = fitted on mounting rail in horizontal row without spacing
b = fitted on mounting rail in horizontal row with 20 mm spacing



24 V DC	24 V AC/DC	115 V AC/DC	230 V AC
0.45 W	-	-	-
0.75 W	0.45 W	-	-
-	-	-	-
-	0,7 VA	0,6 VA	1,2 VA
12 mA	-	-	-
23 mA	12 mA	5 mA	-
-	-	-	-
-	16,5 mA	6 mA	4 mA
2 mA			1 mA
250 V	250 V	250 V	250 V
6 A	6 A	6 A	3 A



Typical making times	
Pick-up delay (AC/DC)	≤ 8 ms
Drop-out delay (AC/DC)	≤ 7 ms

Duration of bounce	≤ 3 ms
Making current	8 A
Making power under ohmic load	2000 VA
Min. switching power / switching current	250 mW/10 mA
Contact material	AgNi 90/10, AgNiO, 15, gold-flashed
Service life	mechanical 24 V DC, 1 A, ohmic load 230 V AC, 3 A, ohmic load

≤ 8 ms	≤ 10 ms / 10 ms	≤ 8 ms / 10 ms	≤ 10 ms
≤ 7 ms	≤ 15 ms / 20 ms	≤ 5 ms / 8 ms	≤ 10 ms

Storage temperature	-40 °C...+60 °C
Ambient temperature	-25 °C...+50 °C
Humidity	40 °C/93 rel. humidity, no condensation

Insulation coordination to EN 50178	
Surge category	III
Pollution severity	2

Dimensions	
Conductor cross-section (screw connection)	0.5...2.5 mm²

DC/AC/AC voltage

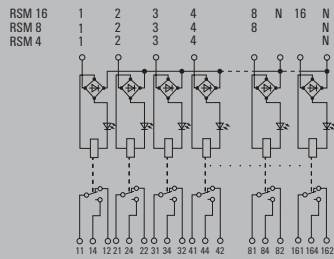

DC voltage, negative-switching

common plus potential,
minus connected

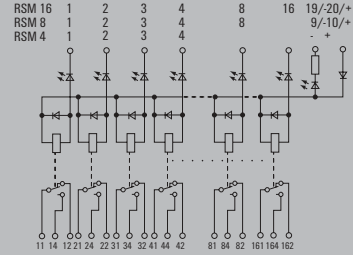

DC voltage, positive-switching

common minus potential,
plus connected

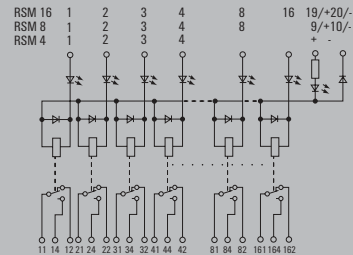

Ordering data

Connection system

Input Screw connection

- Plug-in relay module
Screw connection and multiple plug to IEC 603-1/DIN 41651
- Relay module soldered
Multiple plug to IEC 603-1/DIN 41651

Output Screw connection

Input voltage		4 relay modules	8 relay modules	16 relay modules
		RSM 4 R/RS (B = 75 mm)	RSM 8 R/RS (B = 145 mm)	RSM 16 R/RS (B = 285 mm)
24 V DC, switching plus	Relay module pluggable	1113361001	1113561001	1113761001
	Relay module soldered	1112361001	1107761001	1107861001
24 V DC, switching minus	Relay module pluggable	1113461001	1113661001	1113861001
24 V AC/DC	Relay module pluggable	1173461001	1173561001	1173661001
115 V AC/DC	Relay module pluggable	1114561001	1114661001	1114761001
230 V AC	Relay module pluggable	1114861001	1114961001	1115061001

Spare relay modules (pluggable)

For RSM ... R/RS, 24 V

Input voltage	Contact material	Remarks	Order No.
24 V DC	AgNi 90/10	RT 314024 with clip	8630780000
	AgNi 90/10	RT 314024 without clip	4058480000

For RSM ... R/RS, 48 V

48 V DC	AgNi 90/10	RT 314048 without clip	4058740000
---------	------------	------------------------	------------

For RSM ... R/RS, 115 V and 230 V

115 V DC	AgNi 90/10	RT 314110 with clip	8630770000
	AgNi 90/10	RT 314110 without clip	4058500000

Note: Can also be ordered with clamp for conversion to new RSM relay module.

RSO 30

- Pluggable connections
- DC output up to 3 A @ 5 to 60 V DC
- AC output up to 3 A @ 24 to 240 V AC
- 11 mm modular width

RSO 30-DV/SC



RSO 30-DV/SA



B

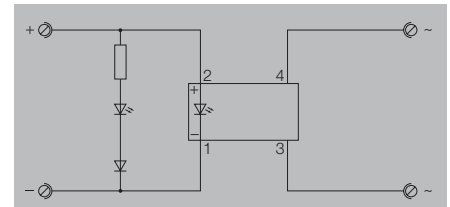
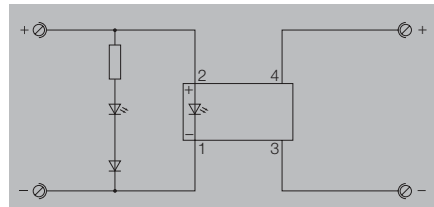

Technical data

Control side

Rated control voltage	5...24 V DC ±20 %
Power rating	No
Rated auxiliary voltage	No
Status indicator	Green LED

Load side

Rated switching voltage	2...60 V DC
Rated switching current	3 A
Voltage drop at max. load	0.1 ms / 0.75 ms
Switch-on delay / Switch-off delay	No /
Short-circuit-proof / Protective circuit, load side	No /

General data

Ambient temperature (operational)	-25 °C...+40 °C
Storage temperature	-40 °C...+85 °C
Humidity	40 °C / 93 % rel. humidity, no condensation
Approvals	CE

Insulation coordination (EN 50 178)

Standards	DIN EN 50178
Rated voltage	300 V
Rated impulse withstand voltage	4 kV
Clearance and creepage distances for control side - load side	≥ 8 mm
Surge voltage category	III
Pollution severity	2

Control side

Rated control voltage	5...24 V DC ±20 %
Power rating	No
Rated auxiliary voltage	No
Status indicator	Green LED

Load side

Rated switching voltage	2...60 V DC
Rated switching current	3 A
Voltage drop at max. load	0.1 ms / 0.75 ms
Switch-on delay / Switch-off delay	No /
Short-circuit-proof / Protective circuit, load side	No /

General data

Ambient temperature (operational)	-25 °C...+40 °C
Storage temperature	-40 °C...+85 °C
Humidity	40 °C / 93 % rel. humidity, no condensation
Approvals	CE

Insulation coordination (EN 50 178)

Standards	DIN EN 50178
Rated voltage	300 V
Rated impulse withstand voltage	4 kV
Clearance and creepage distances for control side - load side	≥ 8 mm
Surge voltage category	III
Pollution severity	2

Control side

Rated control voltage	5...24 V DC ±20 %
Power rating	No
Rated auxiliary voltage	No
Status indicator	Green LED

Load side

Rated switching voltage	24...250 V AC
Rated switching current	3 A
Voltage drop at max. load	1.6 V
Switch-on delay / Switch-off delay	No-voltage switch /
Short-circuit-proof / Protective circuit, load side	No /

General data

Ambient temperature (operational)	-25 °C...+40 °C
Storage temperature	-40 °C...+85 °C
Humidity	40 °C / 93 % rel. humidity, no condensation
Approvals	CE

Insulation coordination (EN 50 178)

Standards	DIN EN 50178
Rated voltage	300 V
Rated impulse withstand voltage	4 kV
Clearance and creepage distances for control side - load side	≥ 8 mm
Surge voltage category	III
Pollution severity	2

Dimensions

Clamping range (nominal / min. / max.)	mm ²	2.5 / 0.5 / 2.5
Length x width x height	mm	50 / 11 / 80

Note

Dimensions

Clamping range (nominal / min. / max.)	mm ²	2.5 / 0.5 / 2.5
Length x width x height	mm	50 / 11 / 80

Note

Dimensions

Clamping range (nominal / min. / max.)	mm ²	2.5 / 0.5 / 2.5
Length x width x height	mm	50 / 11 / 80

Note

Ordering data

Type	Qty.	Order No.
RSO 30/DV 5-24V CC/SC	20	9443100000

Type	Qty.	Order No.
RSO 30/DV 5-24V CC/SC	20	9443100000

Type	Qty.	Order No.
RSO 30/DV 5-24V CC/SA	20	9443110000

Note

Note

Note

Accessories

Note

Note

Note

RSO 31

- Pluggable connections
- DC output up to 3 A @ 5 to 60 V DC
- AC output up to 3 A @ 24 to 240 V AC
- 12.5 mm width
- Pluggable fuse in output circuit

RSO 31 -ODC/F

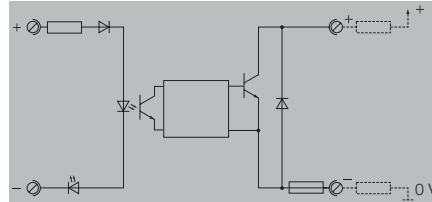

RSO 31 -OAC/F

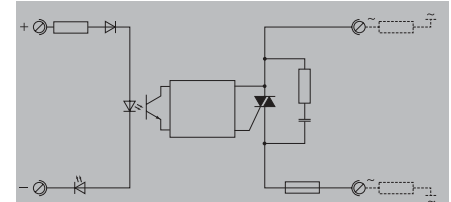

Technical data

Control side	
Rated control voltage	24 V DC ±10 %
Power rating	0.29 W
Rated auxiliary voltage	No
Status indicator	red LED
Load side	
Rated switching voltage	5...50 V DC
Rated switching current	3 A
Voltage drop at max. load	1.6 V
Switch-on delay / Switch-off delay	0.1 ms / 0.75 ms
Short-circuit-proof / Protective circuit, load side	No /
General data	
Ambient temperature (operational)	-25 °C...+40 °C
Storage temperature	-40 °C...+85 °C
Humidity	40 °C / 93 % rel. humidity, no condensation
Approvals	CE
Insulation coordination (EN 50 178)	
Standards	DIN EN 50178
Rated voltage	300 V
Rated impulse withstand voltage	4 kV
Clearance and creepage distances for control side - load side	≥ 8 mm
Surge voltage category	III
Pollution severity	2

Rated control voltage	24 V DC ±10 %
Power rating	0.29 W
Rated auxiliary voltage	No
Status indicator	red LED
Rated switching voltage	5...50 V DC
Rated switching current	3 A
Voltage drop at max. load	1.6 V
Switch-on delay / Switch-off delay	0.1 ms / 0.75 ms
Short-circuit-proof / Protective circuit, load side	No /
Ambient temperature (operational)	-25 °C...+40 °C
Storage temperature	-40 °C...+85 °C
Humidity	40 °C / 93 % rel. humidity, no condensation
Approvals	CE
Standards	DIN EN 50178
Rated voltage	300 V
Rated impulse withstand voltage	4 kV
Clearance and creepage distances for control side - load side	≥ 8 mm
Surge voltage category	III
Pollution severity	2

Rated control voltage	24 V DC ±10 %
Power rating	0.29 W
Rated auxiliary voltage	No
Status indicator	red LED
Rated switching voltage	24...250 V AC
Rated switching current	3 A
Voltage drop at max. load	1.6 V
Switch-on delay / Switch-off delay	No-voltage switch /
Short-circuit-proof / Protective circuit, load side	No /
Ambient temperature (operational)	-25 °C...+40 °C
Storage temperature	-40 °C...+85 °C
Humidity	40 °C / 93 % rel. humidity, no condensation
Approvals	CE
Standards	DIN EN 50178
Rated voltage	300 V
Rated impulse withstand voltage	4 kV
Clearance and creepage distances for control side - load side	≥ 8 mm
Surge voltage category	III
Pollution severity	2

Dimensions	
Clamping range (nominal / min. / max.)	mm ² 2.5 / 0.5 / 2.5
Length x width x height	mm 65.5 / 12.5 / 80
Note	

Clamping range (nominal / min. / max.)	mm ² 2.5 / 0.5 / 2.5
Length x width x height	mm 65.5 / 12.5 / 80
Note	

Clamping range (nominal / min. / max.)	mm ² 2.5 / 0.5 / 2.5
Length x width x height	mm 65.5 / 12.5 / 80
Note	

Ordering data

Type	Qty.	Order No.
RSO31-ODC24/F	20	9430820000

Type	Qty.	Order No.
RSO31-OAC24/F	20	9430320000

Type	Qty.	Order No.
RSO31-OAC24/F	20	9430320000

Note

Note

Note

Accessories

Note

Note

Note

