



CONCEALED HINGE



Note: Nuts are not supplied

Specifications

- Material: Steel
- Finish:
 - Body: Zinc plated
 - Welding Part: Copper plated

Features

- Side part can be mounted with M5 screws
- Center part copper plated for easy welding
- Suitable for heavy-duty applications
- Suitable for 25 mm bend door enclosures
- Applications: Electric panels, machinery covers

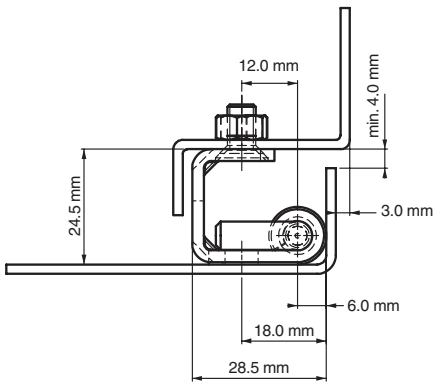
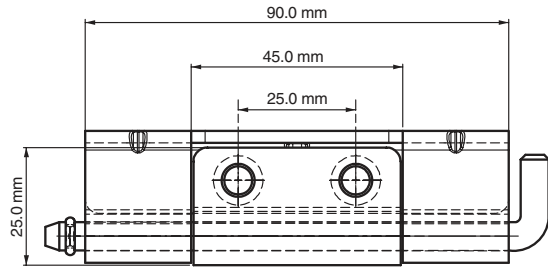
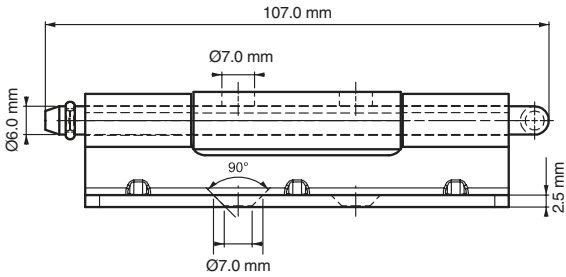

Version 4

Version 3

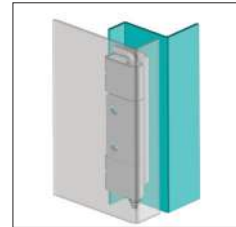
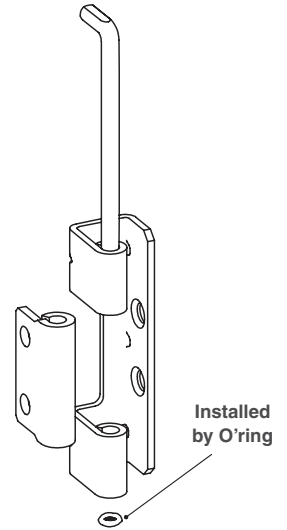
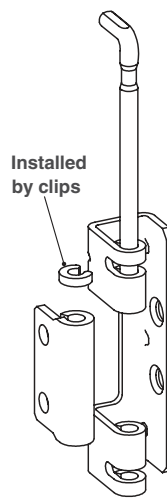

Stud version

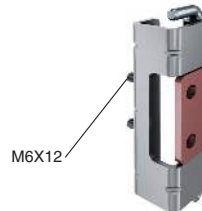

Hinge Rotation Angle



Item Number	Hinge Rotation	Material	Finish	Version	Stud
9956330	110°	Steel	Zinc	3	No
9956331	110°	Steel	Zinc	3	Yes
9956340	110°	Steel	Zinc	4	No
9956341	110°	Steel	Zinc	4	Yes