

# ***Evaluation Module for the TPS65235-1 LNB Voltage Regulator With I<sup>2</sup>C Interface for DiSEqC1.x Application***

This document presents the information required to operate the TPS65235-1 as well as the support documentation including schematic, layout, hardware setup, software application, key waveforms, and bill of materials.

### **Contents**

1	Background .....	2
2	Schematic .....	2
3	Board Layout .....	3
4	Bench Test Setup Conditions .....	5
5	Installing the Software .....	8
6	Software Operation .....	8
7	Test Procedure Example .....	11
8	Bill Of Materials .....	12

### **List of Figures**

1	TPS65235-1 EVM Schematic .....	2
2	Component Placement (Top Layer) .....	3
3	Board Layout (Top Layer) .....	4
4	Board Layout (Bottom Layer) .....	4
5	Headers Description and Jumper Placement .....	5
6	USB Interface Adapter Quick Connection Diagram .....	7
7	GUI Interface Home Page .....	8
8	GUI Bit Register Map Page .....	9
9	GUI Main Control Panel .....	10
10	EXTM has 22-kHz External Tone Input .....	11
11	EXTM has Envelope Input for Tone Output Control .....	11

### **List of Tables**

1	Input/Output Connection .....	6
2	Jumpers and Switches .....	6
3	VLNB Output Control Without I <sup>2</sup> C Interface Connection .....	6
4	I <sup>2</sup> C Address Selection .....	10
5	TPS65235-1 EVM Bill Of Materials .....	12

### **Trademarks**

Microsoft, Windows, Internet Explorer are registered trademarks of Microsoft Corporation.  
 VERISIGN is a registered trademark of Verisign, Inc..  
 All other trademarks are the property of their respective owners.

## 1 Background

The TPS65235-1 is designed to provide 13-V/18-V output voltage for a satellite receiver, with an operational range of 4.5 to 16 V.

The TPS65235-1 features I<sup>2</sup>C-controlled output voltage from 11 V to 20 V with 16 options; output current limit with ±10% accuracy is set with the ISET pin connecting different resistors. The maximum output current limit is up to 1 A.

The TPS65235-1 can also run without I<sup>2</sup>C. In non-I<sup>2</sup>C mode, the SCL pin and VCTRL pin are used to control 13-V/18-V output, these two pins can be controlled by GPIO from the processor. A dedicated enable pin, EN, is available to turn the LNB output on and off.

The evaluation module is designed to provide access to the features of the TPS65235-1 for DiSEqC1.x application. Some modifications can be made to this module to test performance at different input and output voltages, current and switching frequency. Please contact TI Field Applications Group for advice on these matters.

## 2 Schematic

Figure 1 illustrates the TPS65235-1 EVM schematic.

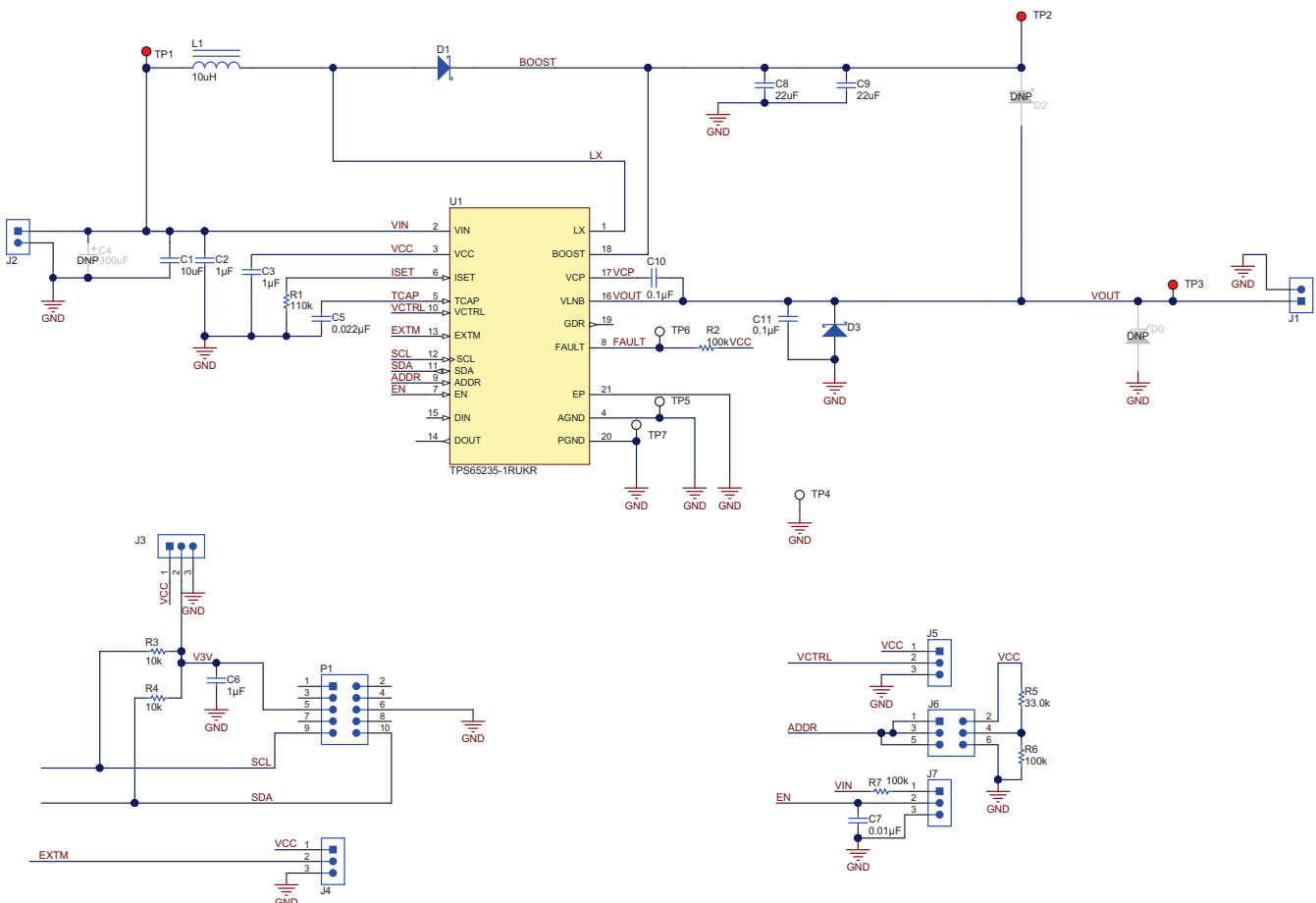

Copyright © 2016, Texas Instruments Incorporated

Figure 1. TPS65235-1 EVM Schematic

In the TPS65235-1 application, the recommended ceramic capacitors rated are at least X7R/X5R, 35-V rating and 1206 size for achieving lower LNB output ripple. For this EVM, two 22-µF, 35-V capacitors, C8 and C9, are put at the output of the boost converter. If lower cost is demanded, a 100-µF electrolytic (low ESR) and a 10-µF/35-V ceramic capacitor also works well.

### 3 Board Layout

Figure 2 shows the component placement on the EVM. Figure 3 and Figure 4 illustrate the top and bottom layers, respectively.

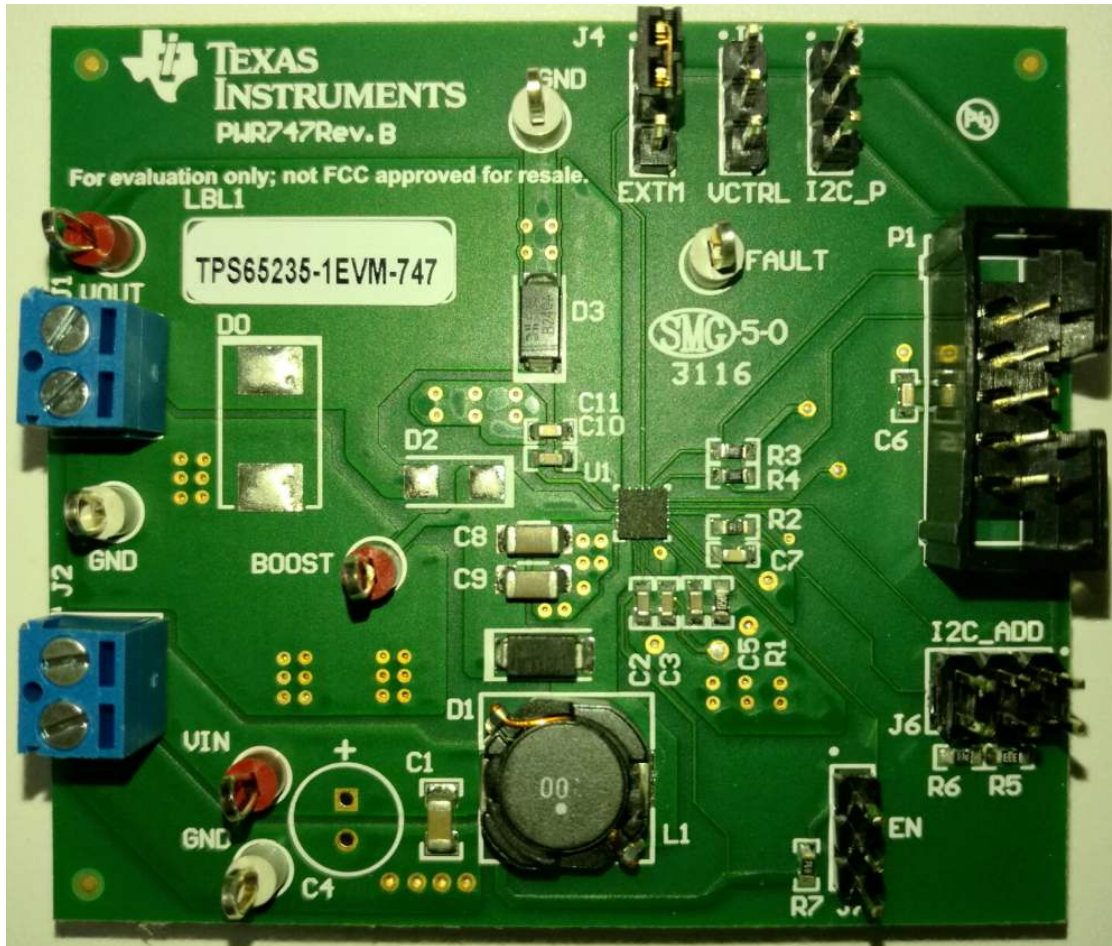

Figure 2. Component Placement (Top Layer)

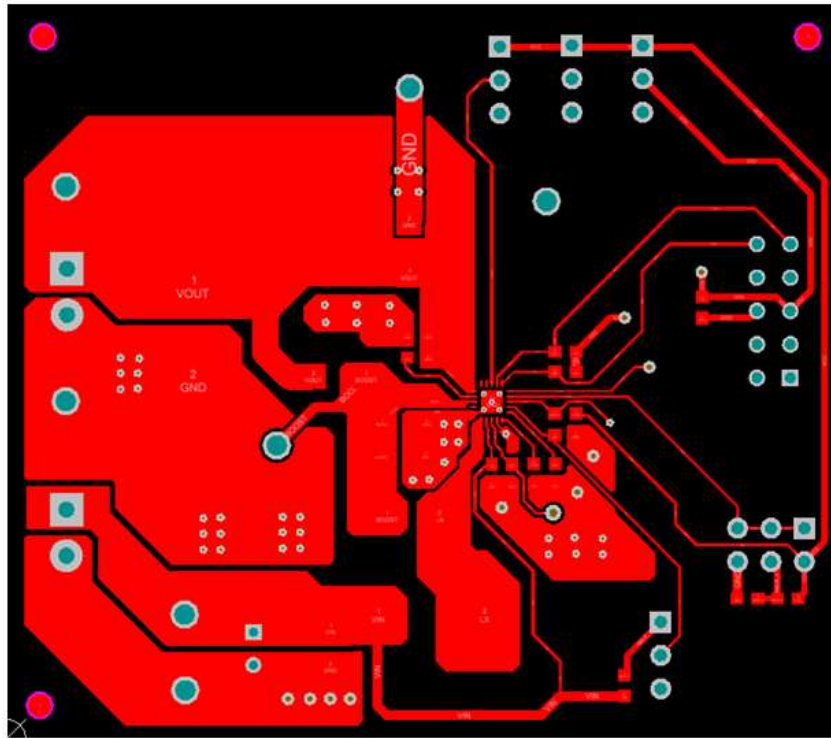

Figure 3. Board Layout (Top Layer)

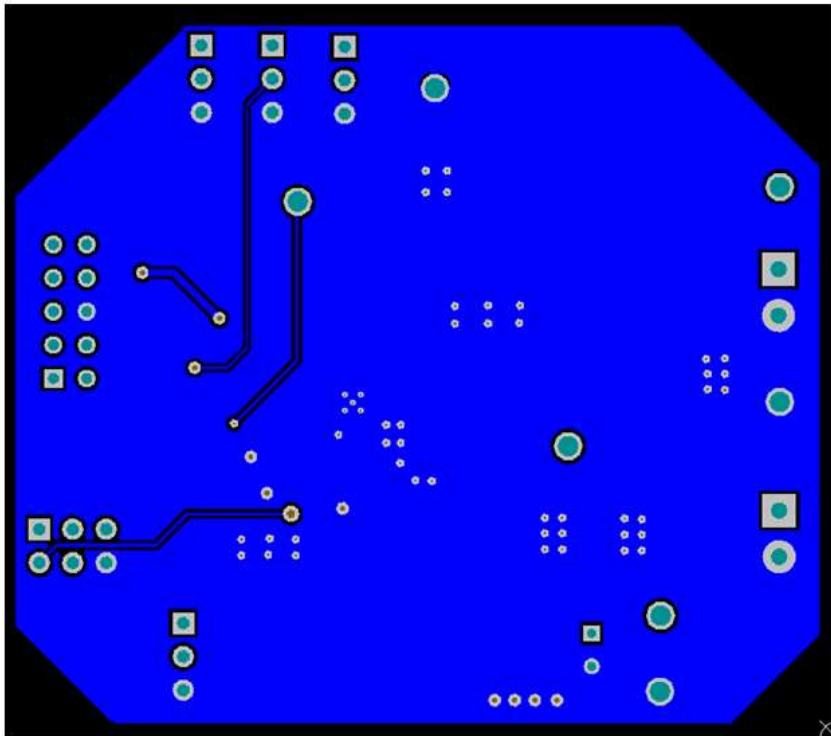

Figure 4. Board Layout (Bottom Layer)

## 4 Bench Test Setup Conditions

### 4.1 Headers Description and Jumper Placement

Figure 5 shows the header descriptions and jumper placement.

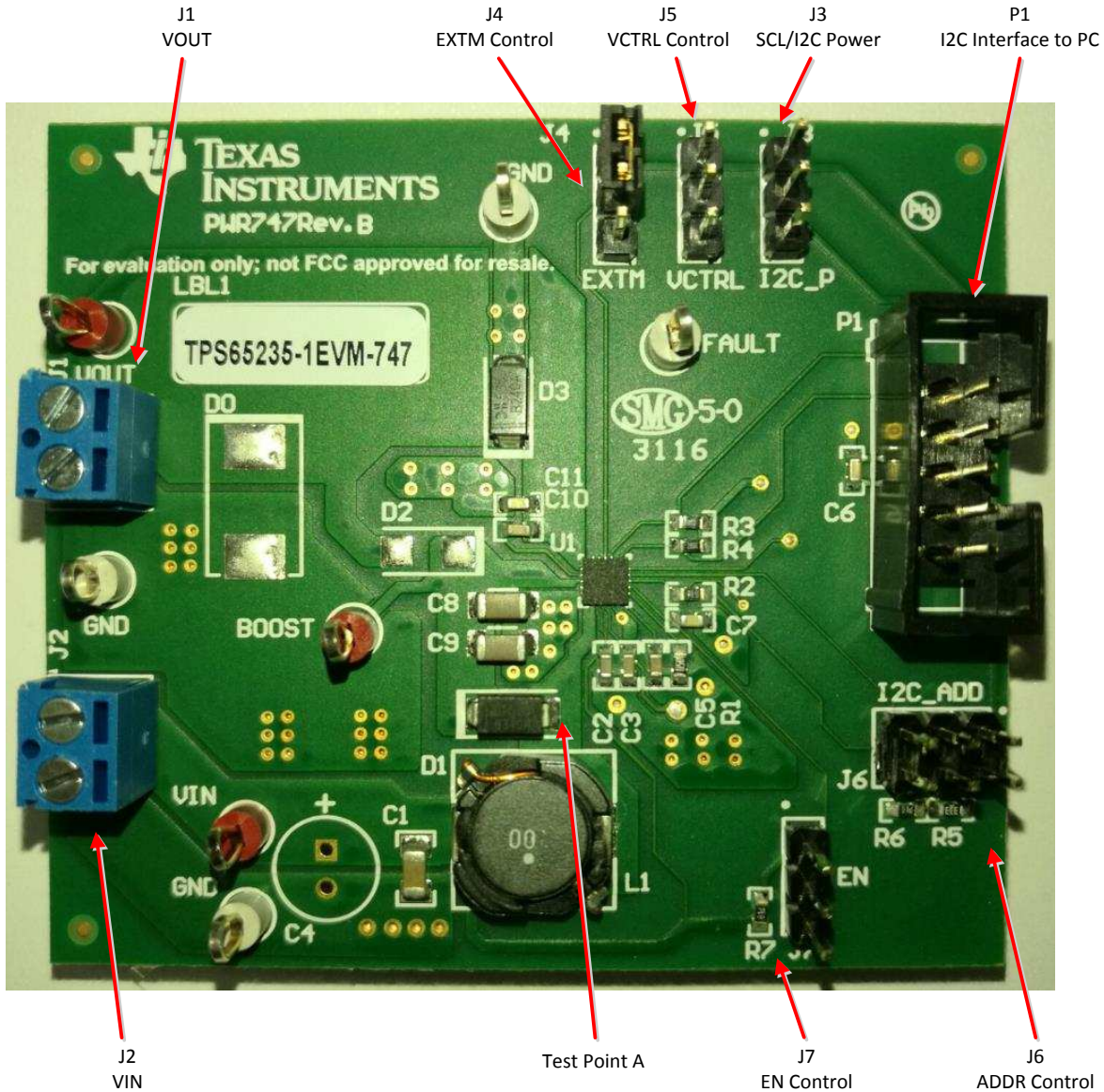

Figure 5. Headers Description and Jumper Placement

#### Test points:

A: LX for Boost

#### Notes:

- At non-I<sup>2</sup>C mode, P1 should be floating, J5 and J3 are used to set the output, refer to [Table 3](#).
- At I<sup>2</sup>C mode, P1 is connected to the PC through the USB-TO-GPIO box, which makes the SCL signal to H. J5 can be used to set the default output when powered on, refer to [Table 3](#).
- P1 and J3 cannot be connected at the same time.

Table 1 lists the I/O connections and Table 2 lists the EVM jumpers and switches.

**Table 1. Input/Output Connection**

#	Function	Description
J1	VOUT Connector	VLNB output
J2	VIN Connector	Apply power supply through this connector

**Table 2. Jumpers and Switches**

#	Function	Placement	Comment
J3	Output voltage control (SCL)	If the IC is not controlled by I <sup>2</sup> C, the VCTRL pin and SCL pin are combined to control the VLNB output voltage. Refer to Table 3 for details.  Jumper J3-2 and J3-1 makes SCL to VCC connection and gives VLNB with output 14.6 V or 19.4 V  Jumper J3-2 and J3-3 makes SCL to GND connection and gives VLNB with output 13.4 V or 18.2 V	
	I <sup>2</sup> C Power	If the IC is controlled by I <sup>2</sup> C, this is used to provide the I <sup>2</sup> C power which is connected to the SCL and SDA through pull-up resistors  Leaving non jumpers connected sets the power to be 3.3 V from the I <sup>2</sup> C interface adaptor  Shorting the J3-1 and J3-2 with a jumper sets the power to be VCC	On-board VCC is 6.3 V
J4	Tone control (EXTM)	Toggle the EXTM signal (J4-2 to J4-3 and then J4-2 to J4-1), the internal tone signal is superimposed at the VLNB output VOOUT  EXTM to GND (J4-2 to J4-3), no internal tone signal is superimposed at VOOUT	
J5	Output voltage control (VCTRL)	If the IC is not controlled by I <sup>2</sup> C, the VCTRL pin and SCL pin are combined to control the VLNB output voltage. Refer to Table 3 for details.  Jumper J5-2 and J5-1 makes VCTRL to VCC connection and gives VLNB with an output of 18.2 V or 19.4 V  Jumper J5-2 and J5-3 makes VCTRL to VCC connection and gives VLNB with an output of 13.4 V or 14.6 V	
J6	I <sup>2</sup> C address set (ADDR)	This pin is the I <sup>2</sup> C address set pin; tie to VCC sets I <sup>2</sup> C address with 0x08H; floating, sets I <sup>2</sup> C address with 0x09H; tie to GND sets I <sup>2</sup> C address with 0x10H; resistor divider R9A and R9B make ADDR pin at the voltage to set the I <sup>2</sup> C address with 0x11H. Refer to Table 4 for details.	With 3 V- VCC - 0.8 V will set the I <sup>2</sup> C address 0x11H;
J7	VLNB output enable (EN)	Connect jumper EN to GND to disable the VLNB output ( shorts J7-2 to J7-3), connect EN to V <sub>IN</sub> through a 100-kΩ resistor to enable the VLNB output (short J7-2 to J7-1)  Leaving open enables VLNB output too.	

**Table 3. VLNB Output Control Without I<sup>2</sup>C Interface Connection**

EN	SCL	VCTRL	VLNB
H	H	H	19.4 V
H	H	L	14.6 V
H	L	H	18.2 V
H	L	L	13.4 V
L	X	X	0 V

## 4.2 Hardware Requirement

This EVM requires an external power supply capable of providing 4.5 V to 16 V at 4 A.

The EVM kit includes the USB-TO-GPIO interface box which, when installed on a PC and connected to the EVM, allows the user to communicate with the EVM via a GUI interface. (The EVM and [USB-TO-GPIO interface box](#) must be ordered separately.) The minimum PC requirements are:

- Microsoft® Windows® 2000, Windows XP or Windows 7 operating system
- USB port
- Minimum of 30MB of free hard disk space (100MB recommended)
- Minimum of 256MB of RAM

## 4.3 Hardware Setup

After connecting the power supply to J2, floating J7, connect J3, J4, and J5 to GND, J6 and P1 floating, turning on the power supply, the EVM will regulate the output voltages to 13.4 V without tone superimposed.

In order to change the output voltage by sending the digital control signal via a PC running the TPS65235-1 controller software and USB-TO-GPIO interface box, perform the following steps:

- Connect one end of the USB-TO-GPIO box to the PC using the USB cable and the other end to P1 of the TPS65235-1 using the supplied 10-pin ribbon cable, per [Figure 6](#). The connectors on the ribbon cable are keyed to prevent incorrect installation.
- Floating J3
- Connect the power supply on J2 and turn on the power supply
- Run the software as explained in the next section.

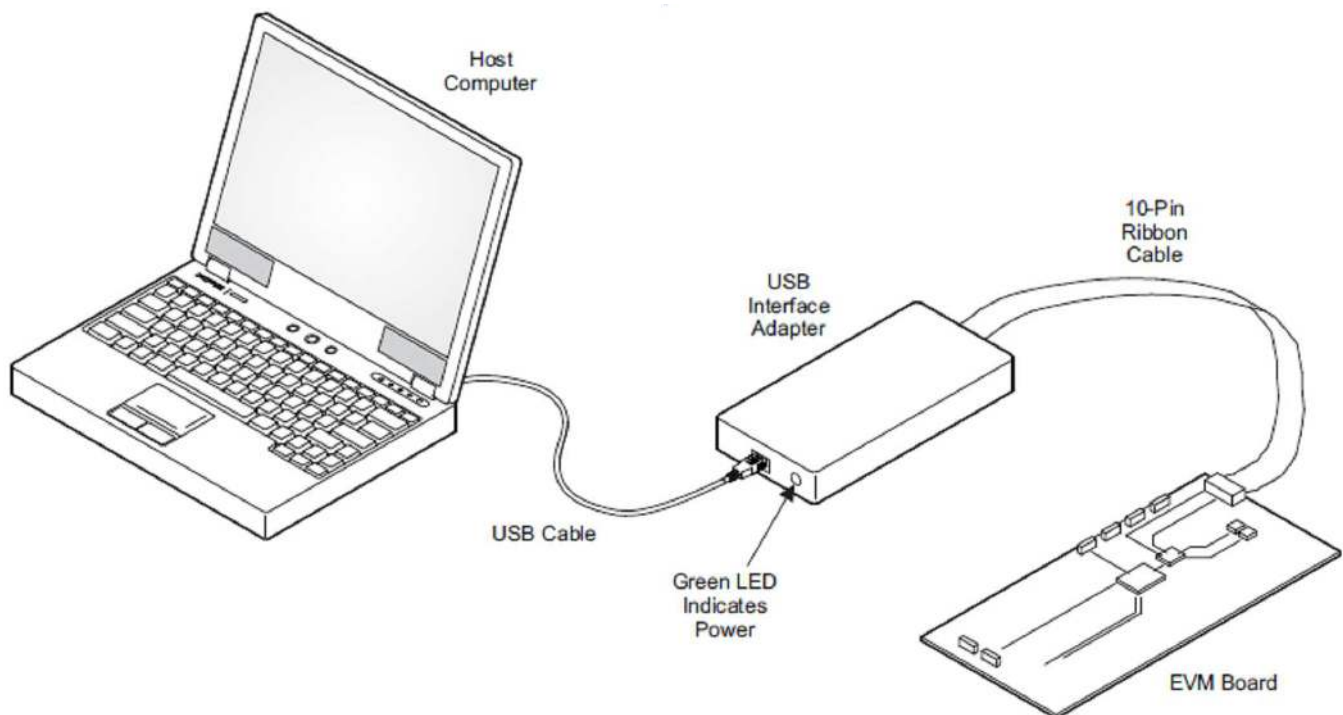

**Figure 6. USB Interface Adapter Quick Connection Diagram**

## 5 Installing the Software

If installing from the TI Web site, visit the [www.ti.com/product/TPS65235-1/toolssoftware](http://www.ti.com/product/TPS65235-1/toolssoftware) URL.

**NOTE:** This installation page is best viewed with Microsoft Internet Explorer® browser (it may not work correctly with other browsers).

1. Click on the install button; your PC should display a security warning and ask if you want to install this application. Select *Install* to proceed.
2. To run the software after installation, either use the desktop icon, which is created by the installer if the user agrees to creating a desktop icon, or go to Start → All programs → Texas Instruments → TPS65235-1.

At start-up, the software first checks the firmware version of the USB-to-GPIO adapter box. If an incorrect firmware version is installed, the software automatically searches on the Internet (if connected) for updates. If a new update is available, the software notifies the user of the update, and downloads and installs the software. Note that after the firmware is updated, the user must disconnect and then reconnect the USB cable between the adapter and PC, as instructed during the install process. The host PC software also automatically searches on the Internet (if connected) for updates. If a new update is available, the software notifies the user of the update and downloads and installs it. During future use of the software, you are prompted to install a new version if one becomes available on the Web.

**NOTE:** VERISIGN® Code Signing is used to prevent any malicious code from changing this application. If at any time in the future the binaries are modified, the code will no longer attempt to run.

## 6 Software Operation

This section provides descriptions of the EVM software.

The supplied software is used to communicate with the TPS65235-1EVM. Click on the icon on the host computer to start the software. The software first displays the home page for the user interface. Entrances are available for the expert user or beginner.

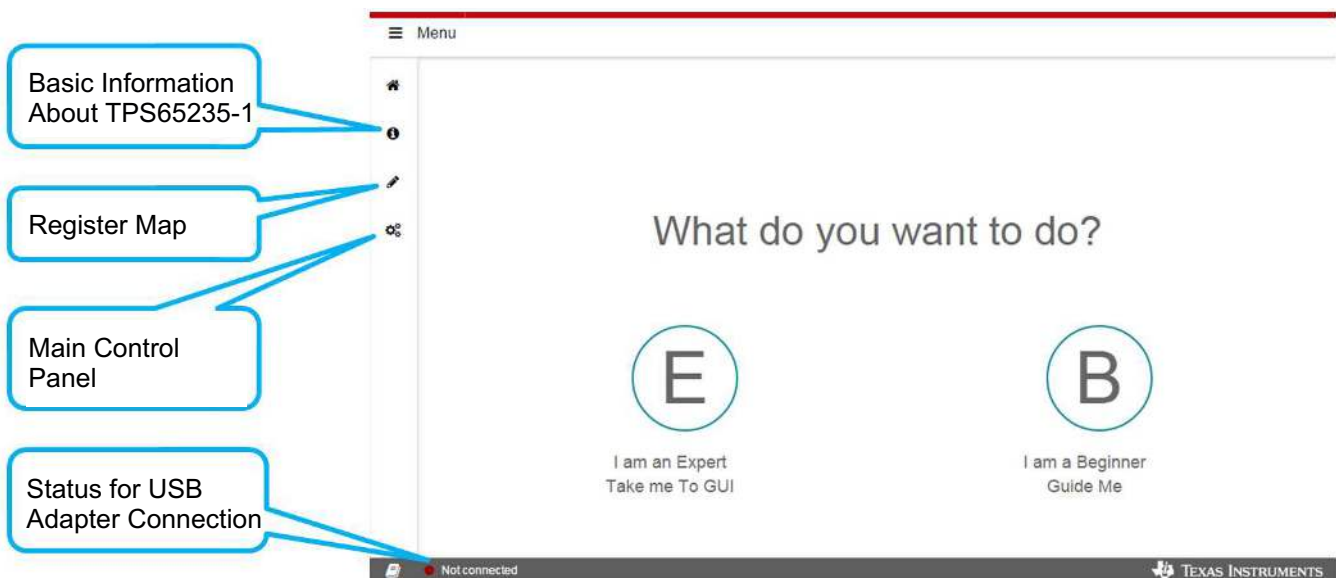

Figure 7. GUI Interface Home Page



Click on the “B” button, the “Basic information about TPS65235-1” page comes up which lists the features and application information for TPS65235-1. Follow the steps, the GUI guides the beginner to setup the EVM and GUI step by step to do the basic check for the EVM.

## 6.1 Register Map Page

Click the “E” button, the Register Map interface (Figure 8) displays.

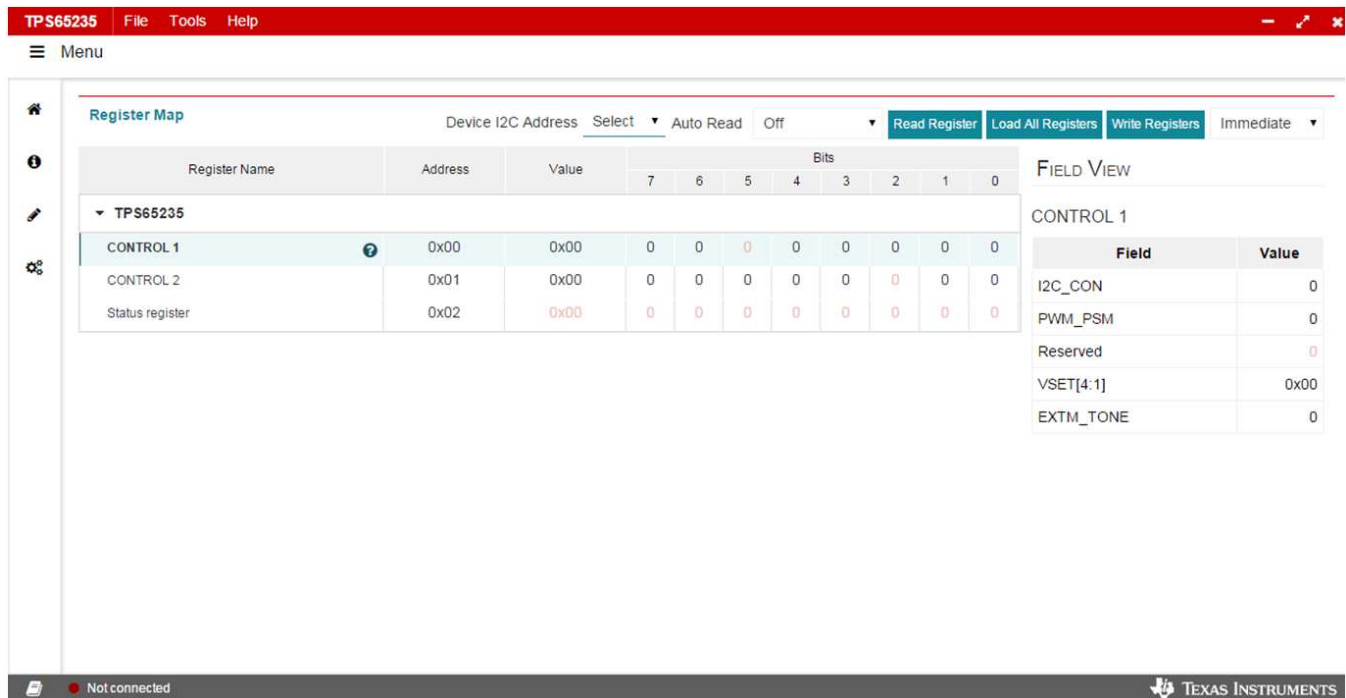

**Figure 8. GUI Bit Register Map Page**

Single click on the register, the right “FIELD VIEW” comes up showing the detail setting of each bit.

Double clicking on the bit can change the it to “0” or “1”.

Single click on the “?” for the register, the detail description page for this register displays.

For the “Write Registers” option, when the “Immediate” button is selected, any change is sent to the EVM immediately; otherwise, “Write Registers” button for each register must be clicked to send the control signal.

Register values can be read back from the EVM by clicking “Read Register” for each register or “Load All Registers” or set the “Auto Read” choice.

The *Status for USB Adapter Connection* only shows the status for the adapter, not the EVM board. The customer can click the Write Registers on the Register Map page to verify the board communication.

## 6.2 Basic Settings

Clicking the main control panel displays the “Basic Settings” interface. This interface provides a simple method for setting registers. Clicking the “Auto Read” button allows the register status to be monitored automatically.

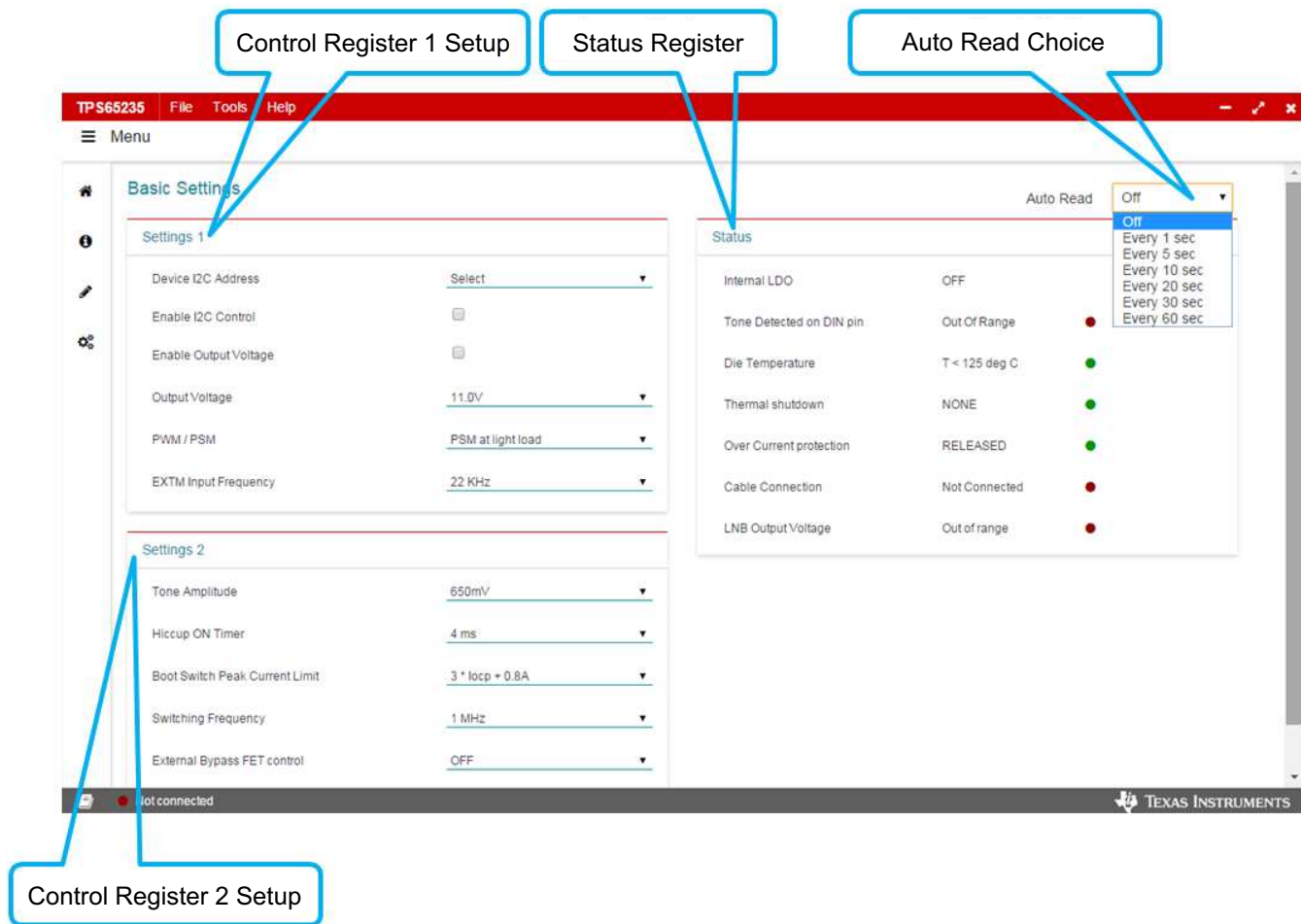

**Figure 9. GUI Main Control Panel**

Figure 7 to Figure 9 show the control GUI interface. There are three 8-bit registers embedded in the TPS65235-1; two to control the output voltage characteristics, and one for status feedback. Make changes by selecting and checking the components on the *Basic Settings* page in the GUI. Changes are also made by directly clicking the bits of each register on the *Register Map* page. Set the I<sup>2</sup>C address with J6 to control the ADDR pin, refer to Table 2 and Table 4.

**Table 4. I<sup>2</sup>C Address Selection**

ADDR Pin	I <sup>2</sup> C Address
Connect to VCC	0x08H
Floating	0x09H
Connected to GND	0x10H
Resistor divider to make ADDR pin voltage in 3 V ~ VCC-0.8 V	0x11H

## 7 Test Procedure Example

### 7.1 Voltage Output Check

Use the following voltage output checks while testing the EVM:

1. Connect I2C adapter to P1
2. Floating J3, J6, and J7, J4 to GND, J5 to GND
3. Apply 12 V to J2
4. Apply loads or non load to the output connector J1, check the output
5. Set the control register 0x00H and 0x01H to the expected output value and then check the output
6. Monitor the status register 0x02H for the IC status

### 7.2 Tone Output

Use the following tone output checks while testing the EVM:

1. Connect I2C adaptor to P1
2. Floating J3, J6, and J7, J5 to GND
3. Apply 12 V to J2
4. Toggle the EXTM (J4) from low to high, check the tone output at VOUT
5. Apply loads or non-load to the output connector J1, check the output

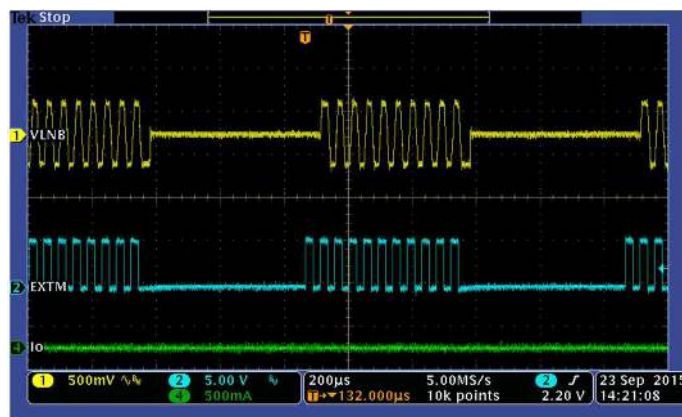

Figure 10. EXTM has 22-kHz External Tone Input

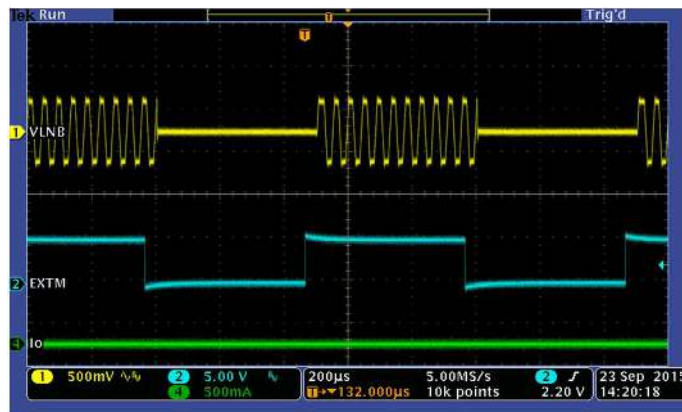

Figure 11. EXTM has Envelope Input for Tone Output Control

## 8 Bill Of Materials

Table 5 lists the EVM BOM.

**Table 5. TPS65235-1EVM Bill Of Materials**

Designator	Description	Manufacturer	Part Number	Qty
PCB1	Printed Circuit Board	Any	PWR747	1
C1	CAP, CERM, 10 $\mu$ F, 25 V, +/- 10%, X5R, 1206	Murata	GRM31CR61E106KA12L	1
C2, C3, C6	CAP, CERM, 1 $\mu$ F, 25 V, +/- 10%, X5R, 0603	Murata	GRM188R61E105KA12D	3
C5	CAP, CERM, 0.022 $\mu$ F, 50 V, +/- 10%, X7R, 0603	Murata	GRM188R71H223KA01D	1
C7	CAP, CERM, 0.01 $\mu$ F, 50 V, +/- 10%, X7R, 0603	Murata	GRM188R71H103KA01D	1
C8, C9	CAP, CERM, 22 $\mu$ F, 35 V, +/- 20%, X5R, 1206_190	TDK	C3216X5R1V226M	2
C10	CAP, CERM, 0.1 $\mu$ F, 16 V, +/- 5%, X7R, 0603	AVX	0603YC104JAT2A	1
C11	CAP, CERM, 0.1 $\mu$ F, 50 V, +/- 10%, X7R, 0603	Murata	GRM188R71H104KA93D	1
D1	Diode, Schottky, 40 V, 3 A, SMA	Diodes Inc.	B340A-13-F	1
D3	Diode, Schottky, 40 V, 2 A, SMA	Diodes Inc.	B240A-13-F	1
H1, H2, H3, H4	Bumpon, Hemisphere, 0.44 X 0.20, Clear	3M	SJ-5303 (CLEAR)	4
J1, J2	Terminal Block, 6A, 3.5mm Pitch, 2-Pos, TH	On-Shore Technology	ED555/2DS	2
J3, J4, J5, J7	Header, 100mil, 3x1, Gold, TH	Samtec	TSW-103-07-G-S	4
J6	Header, 100mil, 3x2, Gold, TH	Samtec	TSW-103-07-G-D	1
L1	Inductor, Shielded, Ferrite, 10 $\mu$ H, 4 A, 0.0312 ohm, SMD	TDK	CLF10040T-100M	1
P1	Header (shrouded), 100mil, 5x2, Gold, TH	Omron Electronic Components	XG4C-1031	1
R1	RES, 110 k, 1%, 0.1 W, 0603	Vishay-Dale	CRCW0603110KFKEA	1
R2, R6, R7	RES, 100 k, 1%, 0.1 W, 0603	Vishay-Dale	CRCW0603100KFKEA	3
R3, R4	RES, 10 k, 5%, 0.1 W, 0603	Vishay-Dale	CRCW060310K0JNEA	2
R5	RES, 33.0 k, 1%, 0.1 W, 0603	Vishay-Dale	CRCW060333K0FKEA	1
SH-J1	Shunt, 100mil, Gold plated, Black	3M	969102-0000-DA	1
TP1, TP2, TP3	Test Point, Multipurpose, Red, TH	Keystone	5010	3
TP4, TP5, TP6, TP7	Test Point, Multipurpose, White, TH	Keystone	5012	4
U1	LNB VOLTAGE REGULATOR WITH I2C INTERFACE	Texas Instruments	TPS65235-1RUKR	1

## STANDARD TERMS AND CONDITIONS FOR EVALUATION MODULES

1. *Delivery:* TI delivers TI evaluation boards, kits, or modules, including demonstration software, components, and/or documentation which may be provided together or separately (collectively, an "EVM" or "EVMs") to the User ("User") in accordance with the terms and conditions set forth herein. Acceptance of the EVM is expressly subject to the following terms and conditions.
  - 1.1 EVMs are intended solely for product or software developers for use in a research and development setting to facilitate feasibility evaluation, experimentation, or scientific analysis of TI semiconductors products. EVMs have no direct function and are not finished products. EVMs shall not be directly or indirectly assembled as a part or subassembly in any finished product. For clarification, any software or software tools provided with the EVM ("Software") shall not be subject to the terms and conditions set forth herein but rather shall be subject to the applicable terms and conditions that accompany such Software
  - 1.2 EVMs are not intended for consumer or household use. EVMs may not be sold, sublicensed, leased, rented, loaned, assigned, or otherwise distributed for commercial purposes by Users, in whole or in part, or used in any finished product or production system.
2. *Limited Warranty and Related Remedies/Disclaimers:*
  - 2.1 These terms and conditions do not apply to Software. The warranty, if any, for Software is covered in the applicable Software License Agreement.
  - 2.2 TI warrants that the TI EVM will conform to TI's published specifications for ninety (90) days after the date TI delivers such EVM to User. Notwithstanding the foregoing, TI shall not be liable for any defects that are caused by neglect, misuse or mistreatment by an entity other than TI, including improper installation or testing, or for any EVMs that have been altered or modified in any way by an entity other than TI. Moreover, TI shall not be liable for any defects that result from User's design, specifications or instructions for such EVMs. Testing and other quality control techniques are used to the extent TI deems necessary or as mandated by government requirements. TI does not test all parameters of each EVM.
  - 2.3 If any EVM fails to conform to the warranty set forth above, TI's sole liability shall be at its option to repair or replace such EVM, or credit User's account for such EVM. TI's liability under this warranty shall be limited to EVMs that are returned during the warranty period to the address designated by TI and that are determined by TI not to conform to such warranty. If TI elects to repair or replace such EVM, TI shall have a reasonable time to repair such EVM or provide replacements. Repaired EVMs shall be warranted for the remainder of the original warranty period. Replaced EVMs shall be warranted for a new full ninety (90) day warranty period.
3. *Regulatory Notices:*
  - 3.1 *United States*
    - 3.1.1 *Notice applicable to EVMs not FCC-Approved:*

This kit is designed to allow product developers to evaluate electronic components, circuitry, or software associated with the kit to determine whether to incorporate such items in a finished product and software developers to write software applications for use with the end product. This kit is not a finished product and when assembled may not be resold or otherwise marketed unless all required FCC equipment authorizations are first obtained. Operation is subject to the condition that this product not cause harmful interference to licensed radio stations and that this product accept harmful interference. Unless the assembled kit is designed to operate under part 15, part 18 or part 95 of this chapter, the operator of the kit must operate under the authority of an FCC license holder or must secure an experimental authorization under part 5 of this chapter.
    - 3.1.2 *For EVMs annotated as FCC – FEDERAL COMMUNICATIONS COMMISSION Part 15 Compliant:*

### CAUTION

This device complies with part 15 of the FCC Rules. Operation is subject to the following two conditions: (1) This device may not cause harmful interference, and (2) this device must accept any interference received, including interference that may cause undesired operation.

Changes or modifications not expressly approved by the party responsible for compliance could void the user's authority to operate the equipment.

### FCC Interference Statement for Class A EVM devices

*NOTE: This equipment has been tested and found to comply with the limits for a Class A digital device, pursuant to part 15 of the FCC Rules. These limits are designed to provide reasonable protection against harmful interference when the equipment is operated in a commercial environment. This equipment generates, uses, and can radiate radio frequency energy and, if not installed and used in accordance with the instruction manual, may cause harmful interference to radio communications. Operation of this equipment in a residential area is likely to cause harmful interference in which case the user will be required to correct the interference at his own expense.*

## FCC Interference Statement for Class B EVM devices

*NOTE: This equipment has been tested and found to comply with the limits for a Class B digital device, pursuant to part 15 of the FCC Rules. These limits are designed to provide reasonable protection against harmful interference in a residential installation. This equipment generates, uses and can radiate radio frequency energy and, if not installed and used in accordance with the instructions, may cause harmful interference to radio communications. However, there is no guarantee that interference will not occur in a particular installation. If this equipment does cause harmful interference to radio or television reception, which can be determined by turning the equipment off and on, the user is encouraged to try to correct the interference by one or more of the following measures:*

- Reorient or relocate the receiving antenna.
- Increase the separation between the equipment and receiver.
- Connect the equipment into an outlet on a circuit different from that to which the receiver is connected.
- Consult the dealer or an experienced radio/TV technician for help.

### 3.2 Canada

3.2.1 For EVMs issued with an Industry Canada Certificate of Conformance to RSS-210

#### Concerning EVMs Including Radio Transmitters:

This device complies with Industry Canada license-exempt RSS standard(s). Operation is subject to the following two conditions: (1) this device may not cause interference, and (2) this device must accept any interference, including interference that may cause undesired operation of the device.

#### Concernant les EVMs avec appareils radio:

Le présent appareil est conforme aux CNR d'Industrie Canada applicables aux appareils radio exempts de licence. L'exploitation est autorisée aux deux conditions suivantes: (1) l'appareil ne doit pas produire de brouillage, et (2) l'utilisateur de l'appareil doit accepter tout brouillage radioélectrique subi, même si le brouillage est susceptible d'en compromettre le fonctionnement.

#### Concerning EVMs Including Detachable Antennas:

Under Industry Canada regulations, this radio transmitter may only operate using an antenna of a type and maximum (or lesser) gain approved for the transmitter by Industry Canada. To reduce potential radio interference to other users, the antenna type and its gain should be so chosen that the equivalent isotropically radiated power (e.i.r.p.) is not more than that necessary for successful communication. This radio transmitter has been approved by Industry Canada to operate with the antenna types listed in the user guide with the maximum permissible gain and required antenna impedance for each antenna type indicated. Antenna types not included in this list, having a gain greater than the maximum gain indicated for that type, are strictly prohibited for use with this device.

#### Concernant les EVMs avec antennes détachables

Conformément à la réglementation d'Industrie Canada, le présent émetteur radio peut fonctionner avec une antenne d'un type et d'un gain maximal (ou inférieur) approuvé pour l'émetteur par Industrie Canada. Dans le but de réduire les risques de brouillage radioélectrique à l'intention des autres utilisateurs, il faut choisir le type d'antenne et son gain de sorte que la puissance isotrope rayonnée équivalente (p.i.r.e.) ne dépasse pas l'intensité nécessaire à l'établissement d'une communication satisfaisante. Le présent émetteur radio a été approuvé par Industrie Canada pour fonctionner avec les types d'antenne énumérés dans le manuel d'usage et ayant un gain admissible maximal et l'impédance requise pour chaque type d'antenne. Les types d'antenne non inclus dans cette liste, ou dont le gain est supérieur au gain maximal indiqué, sont strictement interdits pour l'exploitation de l'émetteur.

### 3.3 Japan

3.3.1 *Notice for EVMs delivered in Japan:* Please see [http://www.tij.co.jp/lstds/ti\\_ja/general/eStore/notice\\_01.page](http://www.tij.co.jp/lstds/ti_ja/general/eStore/notice_01.page) 日本国内に輸入される評価用キット、ボードについては、次のところをご覧ください。  
[http://www.tij.co.jp/lstds/ti\\_ja/general/eStore/notice\\_01.page](http://www.tij.co.jp/lstds/ti_ja/general/eStore/notice_01.page)

3.3.2 *Notice for Users of EVMs Considered "Radio Frequency Products" in Japan:* EVMs entering Japan may not be certified by TI as conforming to Technical Regulations of Radio Law of Japan.

If User uses EVMs in Japan, not certified to Technical Regulations of Radio Law of Japan, User is required by Radio Law of Japan to follow the instructions below with respect to EVMs:

1. Use EVMs in a shielded room or any other test facility as defined in the notification #173 issued by Ministry of Internal Affairs and Communications on March 28, 2006, based on Sub-section 1.1 of Article 6 of the Ministry's Rule for Enforcement of Radio Law of Japan,
2. Use EVMs only after User obtains the license of Test Radio Station as provided in Radio Law of Japan with respect to EVMs, or
3. Use of EVMs only after User obtains the Technical Regulations Conformity Certification as provided in Radio Law of Japan with respect to EVMs. Also, do not transfer EVMs, unless User gives the same notice above to the transferee. Please note that if User does not follow the instructions above, User will be subject to penalties of Radio Law of Japan.

【無線電波を送信する製品の開発キットをお使いになる際の注意事項】 開発キットの中には技術基準適合証明を受けていないものがあります。技術適合証明を受けていないものご使用に際しては、電波法遵守のため、以下のいずれかの措置を取っていただく必要がありますのでご注意ください。

1. 電波法施行規則第6条第1項第1号に基づく平成18年3月28日総務省告示第173号で定められた電波暗室等の試験設備でご使用いただく。
2. 実験局の免許を取得後ご使用いただく。
3. 技術基準適合証明を取得後ご使用いただく。

なお、本製品は、上記の「ご使用にあたっての注意」を譲渡先、移転先に通知しない限り、譲渡、移転できないものとします。

上記を遵守頂けない場合は、電波法の罰則が適用される可能性があることをご留意ください。日本テキサス・インスツルメンツ株式会社

東京都新宿区西新宿 6 丁目 2 4 番 1 号

西新宿三井ビル

3.3.3 *Notice for EVMs for Power Line Communication:* Please see [http://www.tij.co.jp/lstds/ti\\_ja/general/eStore/notice\\_02.page](http://www.tij.co.jp/lstds/ti_ja/general/eStore/notice_02.page)  
電力線搬送波通信についての開発キットをお使いになる際の注意事項については、次のところをご覧ください。 [http://www.tij.co.jp/lstds/ti\\_ja/general/eStore/notice\\_02.page](http://www.tij.co.jp/lstds/ti_ja/general/eStore/notice_02.page)

#### 4 *EVM Use Restrictions and Warnings:*

4.1 EVMS ARE NOT FOR USE IN FUNCTIONAL SAFETY AND/OR SAFETY CRITICAL EVALUATIONS, INCLUDING BUT NOT LIMITED TO EVALUATIONS OF LIFE SUPPORT APPLICATIONS.

4.2 User must read and apply the user guide and other available documentation provided by TI regarding the EVM prior to handling or using the EVM, including without limitation any warning or restriction notices. The notices contain important safety information related to, for example, temperatures and voltages.

#### 4.3 *Safety-Related Warnings and Restrictions:*

4.3.1 User shall operate the EVM within TI's recommended specifications and environmental considerations stated in the user guide, other available documentation provided by TI, and any other applicable requirements and employ reasonable and customary safeguards. Exceeding the specified performance ratings and specifications (including but not limited to input and output voltage, current, power, and environmental ranges) for the EVM may cause personal injury or death, or property damage. If there are questions concerning performance ratings and specifications, User should contact a TI field representative prior to connecting interface electronics including input power and intended loads. Any loads applied outside of the specified output range may also result in unintended and/or inaccurate operation and/or possible permanent damage to the EVM and/or interface electronics. Please consult the EVM user guide prior to connecting any load to the EVM output. If there is uncertainty as to the load specification, please contact a TI field representative. During normal operation, even with the inputs and outputs kept within the specified allowable ranges, some circuit components may have elevated case temperatures. These components include but are not limited to linear regulators, switching transistors, pass transistors, current sense resistors, and heat sinks, which can be identified using the information in the associated documentation. When working with the EVM, please be aware that the EVM may become very warm.

4.3.2 EVMs are intended solely for use by technically qualified, professional electronics experts who are familiar with the dangers and application risks associated with handling electrical mechanical components, systems, and subsystems. User assumes all responsibility and liability for proper and safe handling and use of the EVM by User or its employees, affiliates, contractors or designees. User assumes all responsibility and liability to ensure that any interfaces (electronic and/or mechanical) between the EVM and any human body are designed with suitable isolation and means to safely limit accessible leakage currents to minimize the risk of electrical shock hazard. User assumes all responsibility and liability for any improper or unsafe handling or use of the EVM by User or its employees, affiliates, contractors or designees.

4.4 User assumes all responsibility and liability to determine whether the EVM is subject to any applicable international, federal, state, or local laws and regulations related to User's handling and use of the EVM and, if applicable, User assumes all responsibility and liability for compliance in all respects with such laws and regulations. User assumes all responsibility and liability for proper disposal and recycling of the EVM consistent with all applicable international, federal, state, and local requirements.

5. *Accuracy of Information:* To the extent TI provides information on the availability and function of EVMs, TI attempts to be as accurate as possible. However, TI does not warrant the accuracy of EVM descriptions, EVM availability or other information on its websites as accurate, complete, reliable, current, or error-free.

6. *Disclaimers:*
- 6.1 EXCEPT AS SET FORTH ABOVE, EVMS AND ANY WRITTEN DESIGN MATERIALS PROVIDED WITH THE EVM (AND THE DESIGN OF THE EVM ITSELF) ARE PROVIDED "AS IS" AND "WITH ALL FAULTS." TI DISCLAIMS ALL OTHER WARRANTIES, EXPRESS OR IMPLIED, REGARDING SUCH ITEMS, INCLUDING BUT NOT LIMITED TO ANY IMPLIED WARRANTIES OF MERCHANTABILITY OR FITNESS FOR A PARTICULAR PURPOSE OR NON-INFRINGEMENT OF ANY THIRD PARTY PATENTS, COPYRIGHTS, TRADE SECRETS OR OTHER INTELLECTUAL PROPERTY RIGHTS.
- 6.2 EXCEPT FOR THE LIMITED RIGHT TO USE THE EVM SET FORTH HEREIN, NOTHING IN THESE TERMS AND CONDITIONS SHALL BE CONSTRUED AS GRANTING OR CONFERRING ANY RIGHTS BY LICENSE, PATENT, OR ANY OTHER INDUSTRIAL OR INTELLECTUAL PROPERTY RIGHT OF TI, ITS SUPPLIERS/LICENSORS OR ANY OTHER THIRD PARTY, TO USE THE EVM IN ANY FINISHED END-USER OR READY-TO-USE FINAL PRODUCT, OR FOR ANY INVENTION, DISCOVERY OR IMPROVEMENT MADE, CONCEIVED OR ACQUIRED PRIOR TO OR AFTER DELIVERY OF THE EVM.
7. *USER'S INDEMNITY OBLIGATIONS AND REPRESENTATIONS.* USER WILL DEFEND, INDEMNIFY AND HOLD TI, ITS LICENSORS AND THEIR REPRESENTATIVES HARMLESS FROM AND AGAINST ANY AND ALL CLAIMS, DAMAGES, LOSSES, EXPENSES, COSTS AND LIABILITIES (COLLECTIVELY, "CLAIMS") ARISING OUT OF OR IN CONNECTION WITH ANY HANDLING OR USE OF THE EVM THAT IS NOT IN ACCORDANCE WITH THESE TERMS AND CONDITIONS. THIS OBLIGATION SHALL APPLY WHETHER CLAIMS ARISE UNDER STATUTE, REGULATION, OR THE LAW OF TORT, CONTRACT OR ANY OTHER LEGAL THEORY, AND EVEN IF THE EVM FAILS TO PERFORM AS DESCRIBED OR EXPECTED.
8. *Limitations on Damages and Liability:*
- 8.1 *General Limitations.* IN NO EVENT SHALL TI BE LIABLE FOR ANY SPECIAL, COLLATERAL, INDIRECT, PUNITIVE, INCIDENTAL, CONSEQUENTIAL, OR EXEMPLARY DAMAGES IN CONNECTION WITH OR ARISING OUT OF THESE TERMS AND CONDITIONS OR THE USE OF THE EVMS PROVIDED HEREUNDER, REGARDLESS OF WHETHER TI HAS BEEN ADVISED OF THE POSSIBILITY OF SUCH DAMAGES. EXCLUDED DAMAGES INCLUDE, BUT ARE NOT LIMITED TO, COST OF REMOVAL OR REINSTALLATION, ANCILLARY COSTS TO THE PROCUREMENT OF SUBSTITUTE GOODS OR SERVICES, RETESTING, OUTSIDE COMPUTER TIME, LABOR COSTS, LOSS OF GOODWILL, LOSS OF PROFITS, LOSS OF SAVINGS, LOSS OF USE, LOSS OF DATA, OR BUSINESS INTERRUPTION. NO CLAIM, SUIT OR ACTION SHALL BE BROUGHT AGAINST TI MORE THAN ONE YEAR AFTER THE RELATED CAUSE OF ACTION HAS OCCURRED.
- 8.2 *Specific Limitations.* IN NO EVENT SHALL TI'S AGGREGATE LIABILITY FROM ANY WARRANTY OR OTHER OBLIGATION ARISING OUT OF OR IN CONNECTION WITH THESE TERMS AND CONDITIONS, OR ANY USE OF ANY TI EVM PROVIDED HEREUNDER, EXCEED THE TOTAL AMOUNT PAID TO TI FOR THE PARTICULAR UNITS SOLD UNDER THESE TERMS AND CONDITIONS WITH RESPECT TO WHICH LOSSES OR DAMAGES ARE CLAIMED. THE EXISTENCE OF MORE THAN ONE CLAIM AGAINST THE PARTICULAR UNITS SOLD TO USER UNDER THESE TERMS AND CONDITIONS SHALL NOT ENLARGE OR EXTEND THIS LIMIT.
9. *Return Policy.* Except as otherwise provided, TI does not offer any refunds, returns, or exchanges. Furthermore, no return of EVM(s) will be accepted if the package has been opened and no return of the EVM(s) will be accepted if they are damaged or otherwise not in a resalable condition. If User feels it has been incorrectly charged for the EVM(s) it ordered or that delivery violates the applicable order, User should contact TI. All refunds will be made in full within thirty (30) working days from the return of the components(s), excluding any postage or packaging costs.
10. *Governing Law:* These terms and conditions shall be governed by and interpreted in accordance with the laws of the State of Texas, without reference to conflict-of-laws principles. User agrees that non-exclusive jurisdiction for any dispute arising out of or relating to these terms and conditions lies within courts located in the State of Texas and consents to venue in Dallas County, Texas. Notwithstanding the foregoing, any judgment may be enforced in any United States or foreign court, and TI may seek injunctive relief in any United States or foreign court.

Mailing Address: Texas Instruments, Post Office Box 655303, Dallas, Texas 75265  
Copyright © 2016, Texas Instruments Incorporated



## IMPORTANT NOTICE

Texas Instruments Incorporated and its subsidiaries (TI) reserve the right to make corrections, enhancements, improvements and other changes to its semiconductor products and services per JESD46, latest issue, and to discontinue any product or service per JESD48, latest issue. Buyers should obtain the latest relevant information before placing orders and should verify that such information is current and complete. All semiconductor products (also referred to herein as "components") are sold subject to TI's terms and conditions of sale supplied at the time of order acknowledgment.

TI warrants performance of its components to the specifications applicable at the time of sale, in accordance with the warranty in TI's terms and conditions of sale of semiconductor products. Testing and other quality control techniques are used to the extent TI deems necessary to support this warranty. Except where mandated by applicable law, testing of all parameters of each component is not necessarily performed.

TI assumes no liability for applications assistance or the design of Buyers' products. Buyers are responsible for their products and applications using TI components. To minimize the risks associated with Buyers' products and applications, Buyers should provide adequate design and operating safeguards.

TI does not warrant or represent that any license, either express or implied, is granted under any patent right, copyright, mask work right, or other intellectual property right relating to any combination, machine, or process in which TI components or services are used. Information published by TI regarding third-party products or services does not constitute a license to use such products or services or a warranty or endorsement thereof. Use of such information may require a license from a third party under the patents or other intellectual property of the third party, or a license from TI under the patents or other intellectual property of TI.

Reproduction of significant portions of TI information in TI data books or data sheets is permissible only if reproduction is without alteration and is accompanied by all associated warranties, conditions, limitations, and notices. TI is not responsible or liable for such altered documentation. Information of third parties may be subject to additional restrictions.

Resale of TI components or services with statements different from or beyond the parameters stated by TI for that component or service voids all express and any implied warranties for the associated TI component or service and is an unfair and deceptive business practice. TI is not responsible or liable for any such statements.

Buyer acknowledges and agrees that it is solely responsible for compliance with all legal, regulatory and safety-related requirements concerning its products, and any use of TI components in its applications, notwithstanding any applications-related information or support that may be provided by TI. Buyer represents and agrees that it has all the necessary expertise to create and implement safeguards which anticipate dangerous consequences of failures, monitor failures and their consequences, lessen the likelihood of failures that might cause harm and take appropriate remedial actions. Buyer will fully indemnify TI and its representatives against any damages arising out of the use of any TI components in safety-critical applications.

In some cases, TI components may be promoted specifically to facilitate safety-related applications. With such components, TI's goal is to help enable customers to design and create their own end-product solutions that meet applicable functional safety standards and requirements. Nonetheless, such components are subject to these terms.

No TI components are authorized for use in FDA Class III (or similar life-critical medical equipment) unless authorized officers of the parties have executed a special agreement specifically governing such use.

Only those TI components which TI has specifically designated as military grade or "enhanced plastic" are designed and intended for use in military/aerospace applications or environments. Buyer acknowledges and agrees that any military or aerospace use of TI components which have **not** been so designated is solely at the Buyer's risk, and that Buyer is solely responsible for compliance with all legal and regulatory requirements in connection with such use.

TI has specifically designated certain components as meeting ISO/TS16949 requirements, mainly for automotive use. In any case of use of non-designated products, TI will not be responsible for any failure to meet ISO/TS16949.

### Products

Audio	<a href="http://www.ti.com/audio">www.ti.com/audio</a>
Amplifiers	<a href="http://amplifier.ti.com">amplifier.ti.com</a>
Data Converters	<a href="http://dataconverter.ti.com">dataconverter.ti.com</a>
DLP® Products	<a href="http://www.dlp.com">www.dlp.com</a>
DSP	<a href="http://dsp.ti.com">dsp.ti.com</a>
Clocks and Timers	<a href="http://www.ti.com/clocks">www.ti.com/clocks</a>
Interface	<a href="http://interface.ti.com">interface.ti.com</a>
Logic	<a href="http://logic.ti.com">logic.ti.com</a>
Power Mgmt	<a href="http://power.ti.com">power.ti.com</a>
Microcontrollers	<a href="http://microcontroller.ti.com">microcontroller.ti.com</a>
RFID	<a href="http://www.ti-rfid.com">www.ti-rfid.com</a>
OMAP Applications Processors	<a href="http://www.ti.com/omap">www.ti.com/omap</a>
Wireless Connectivity	<a href="http://www.ti.com/wirelessconnectivity">www.ti.com/wirelessconnectivity</a>

### Applications

Automotive and Transportation	<a href="http://www.ti.com/automotive">www.ti.com/automotive</a>
Communications and Telecom	<a href="http://www.ti.com/communications">www.ti.com/communications</a>
Computers and Peripherals	<a href="http://www.ti.com/computers">www.ti.com/computers</a>
Consumer Electronics	<a href="http://www.ti.com/consumer-apps">www.ti.com/consumer-apps</a>
Energy and Lighting	<a href="http://www.ti.com/energy">www.ti.com/energy</a>
Industrial	<a href="http://www.ti.com/industrial">www.ti.com/industrial</a>
Medical	<a href="http://www.ti.com/medical">www.ti.com/medical</a>
Security	<a href="http://www.ti.com/security">www.ti.com/security</a>
Space, Avionics and Defense	<a href="http://www.ti.com/space-avionics-defense">www.ti.com/space-avionics-defense</a>
Video and Imaging	<a href="http://www.ti.com/video">www.ti.com/video</a>

### TI E2E Community

[e2e.ti.com](http://e2e.ti.com)