

## Mosfet

Metal Oxide Semiconductor Field Effect Transistor

## OptiMOS™ Power-Transistor, -30V

BSL303SPE

## Data Sheet

Rev. 2.0  
Final

Industrial & Multimarket

**OptiMOS™-P 3 Small-Signal-Transistor**
**Features**

- P-channel
- Enhancement mode
- Logic level (4.5V rated)
- ESD protected
- Avalanche rated
- Qualified according to AEC Q101
- 100% Lead-free; RoHS compliant, halogen free

**Product Summary**

$V_{DS}$	-30	V
$R_{DS(on),max}$	$V_{GS}=-10\text{ V}$	33
	$V_{GS}=-4.5\text{ V}$	52
$I_D$	-6.3	A

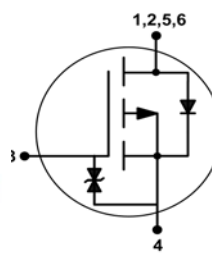
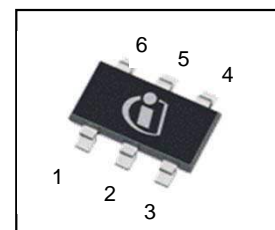
**PG-TSOP-6**

Type	Package	Tape and Reel Information	Marking	Hal. Free	Packing
BSL303SPE	PG-TSOP-6	H6327: 3000 pcs/ reel	sPV	Yes	Non dry

**Maximum ratings, at  $T_j=25\text{ °C}$ , unless otherwise specified**

Parameter	Symbol	Conditions	Value	Unit
Continuous drain current	$I_D$	$T_A=25\text{ °C}$	-6.3	A
		$T_A=70\text{ °C}$	-5.0	
Pulsed drain current	$I_{D,pulse}$	$T_A=25\text{ °C}$	-25.2	
Avalanche energy, single pulse	$E_{AS}$	$I_D=-6.3\text{ A}$ , $R_{GS}=25\ \Omega$	30.0	mJ
Reverse diode $dv/dt$	$dv/dt$	$I_D=-6.3\text{ A}$ , $V_{DS}=-15\text{ V}$ , $di/dt=100\text{ A}/\mu\text{s}$ , $T_{j,max}=150\text{ °C}$	6	kV/ $\mu\text{s}$
Gate source voltage	$V_{GS}$		$\pm 20$	V
Power dissipation	$P_{tot}$	$T_A=25\text{ °C}$	2.0	W
Operating and storage temperature	$T_j$ , $T_{stg}$		-55 ... 150	$^{\circ}\text{C}$
ESD Class		JESD22-A114 -HBM	2 (2KV to 4kV)	V
Soldering Temperature			260 $^{\circ}\text{C}$	$^{\circ}\text{C}$
IEC climatic category; DIN IEC 68-1			55/150/56	$^{\circ}\text{C}$

Parameter	Symbol	Conditions	Values			Unit
			min.	typ.	max.	

**Thermal characteristics**

Thermal resistance, junction - minimal footprint	$R_{thJS}$		-	-	50	K/W
SMD version, device on PCB	$R_{thJA}$	minimal footprint	-	-	230	
		6 cm <sup>2</sup> cooling area <sup>1)</sup>	-	-	62.5	

**Electrical characteristics, at  $T_j=25\text{ °C}$ , unless otherwise specified**
**Static characteristics**

Drain-source breakdown voltage	$V_{(BR)DSS}$	$V_{GS}=0V, I_D=-250\mu A$	-30	-	-	V
Gate threshold voltage	$V_{GS(th)}$	$V_{DS}=0V, I_D=-30\mu A$	-2	-1.5	-1	
Drain-source leakage current	$I_{DSS}$	$V_{DS}=-30V, V_{GS}=0V, T_j=25\text{ °C}$	-	-	-0.1	$\mu A$
		$V_{DS}=-30V, V_{GS}=0V, T_j=150\text{ °C}$	-	-	-20	
Gate-source leakage current	$I_{GSS}$	$V_{GS}=-20V, V_{DS}=0V$	-	-	-7	$\mu A$
Drain-source on-state resistance	$R_{DS(on)}$	$V_{GS}=-4.5V, I_D=-5A$	-	35	52	m $\Omega$
		$V_{GS}=-10V, I_D=-6.3A$	-	25	33	
Transconductance	$g_{fs}$	$ V_{DS} >2 I_D R_{DS(on)max}, I_D=-5A$		12.9	-	S

<sup>1)</sup> Device on 40 mm x 40 mm x 1.5 mm epoxy PCB FR4 with 6 cm<sup>2</sup> (single layer, 70  $\mu m$  thick) copper area for drain connection. PCB is vertical in still air. ( $t < 5$  sec.)

Parameter	Symbol	Conditions	Values			Unit
			min.	typ.	max.	

**Dynamic characteristics<sup>2)</sup>**

Input capacitance	$C_{iss}$	$V_{GS}=0\text{ V}, V_{DS}=-15\text{ V},$ $f=1\text{ MHz}$	-	1053	1401	pF
Output capacitance	$C_{oss}$		-	482	641	
Reverse transfer capacitance	$C_{rss}$		-	33	50	
Turn-on delay time	$t_{d(on)}$	$V_{DD}=-15\text{ V}, V_{GS}=-$ $10\text{ V}, I_D=-6.3\text{ A},$ $R_{G,ext}=6\ \Omega$	-	8.0	12	ns
Rise time	$t_r$		-	7.7	12	
Turn-off delay time	$t_{d(off)}$		-	23.7	36	
Fall time	$t_f$		-	8.3	12	

**Gate Charge Characteristics<sup>2)</sup>**

Gate to source charge	$Q_{gs}$	$V_{DD}=-15\text{ V}, I_D=-6.3\text{ A},$ $V_{GS}=0\text{ to }-10\text{ V}$	-	3.3	4.4	nC
Gate to drain charge	$Q_{gd}$		-	1.6	2.4	
Gate charge total	$Q_g$		-	14.0	20.9	
Gate plateau voltage	$V_{plateau}$		-	3.1	-	V

**Reverse Diode**

Diode continuous forward current	$I_S$	$T_A=25\text{ }^\circ\text{C}$	-	-	-6.3	A
Diode pulse current	$I_{S,pulse}$		-	-	-25.2	
Diode forward voltage	$V_{SD}$	$V_{GS}=0\text{ V}, I_F=-6.3\text{ A},$ $T_j=25\text{ }^\circ\text{C}$	-	-0.9	-1.1	V
Reverse recovery time <sup>2)</sup>	$t_{rr}$	$V_R=-15\text{ V}, I_F=-6.3\text{ A},$ $di_F/dt=100\text{ A}/\mu\text{s}$	-	33	49	ns
Reverse recovery charge <sup>2)</sup>	$Q_{rr}$		-	28	43	nC

<sup>2)</sup> Defined by design. Not subjected to production test

**1 Power dissipation**

$P_{tot}=f(T_A)$

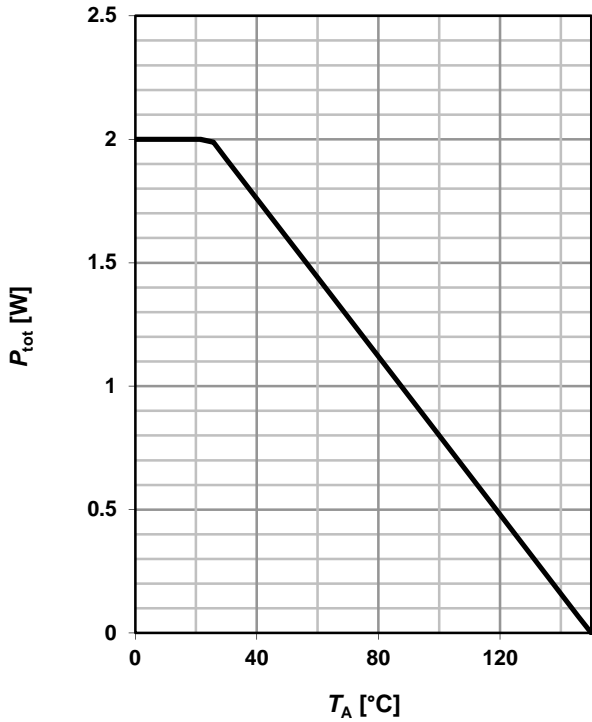

**2 Drain current**

$I_D=f(T_A); V_{GS} \leq -10\text{ V}$

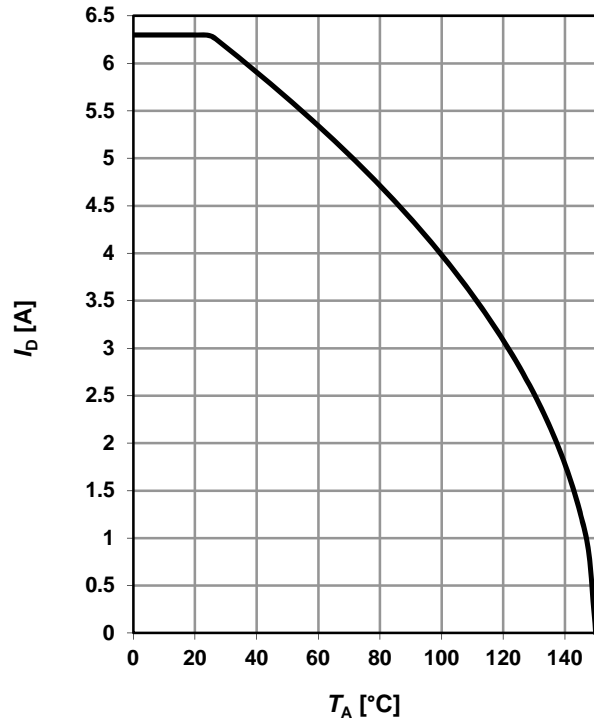

**3 Safe operating area**

$I_D=f(V_{DS}); T_A=25\text{ °C}; D=0$

parameter:  $t_p$

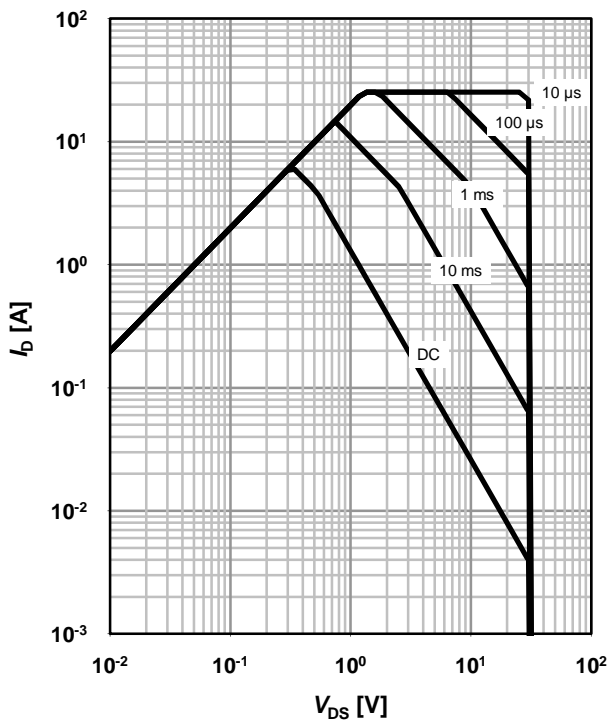

**4 Max. transient thermal impedance**

$Z_{thJA}=f(t_p)$

parameter:  $D=t_p/T$

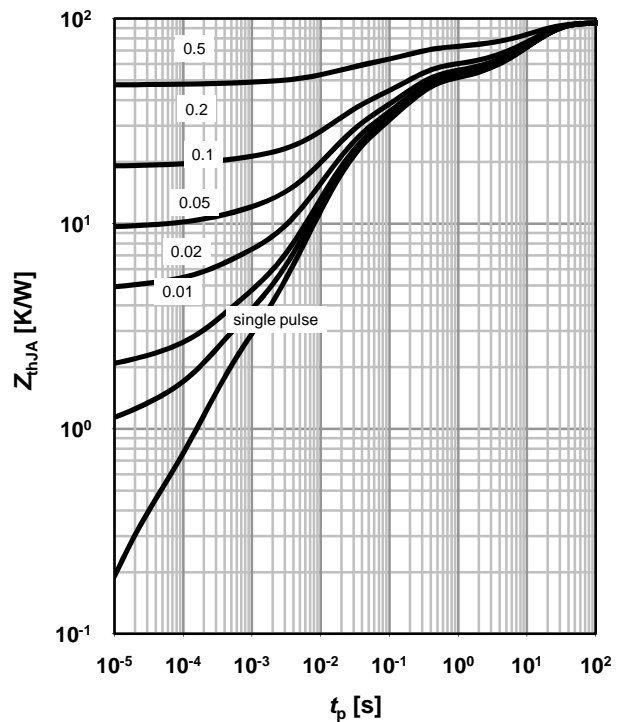

**5 Typ. output characteristics**

$I_D=f(V_{DS}); T_j=25\text{ }^\circ\text{C}$

parameter:  $V_{GS}$

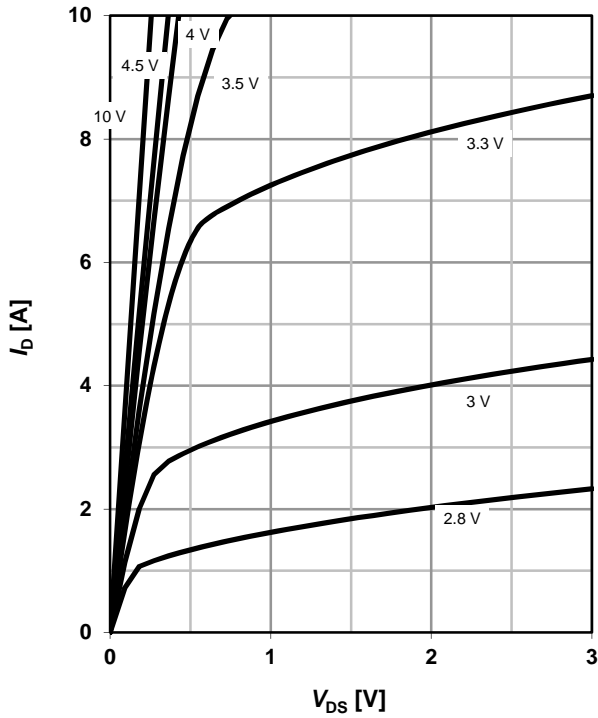

**6 Typ. drain-source on resistance**

$R_{DS(on)}=f(I_D); T_j=25\text{ }^\circ\text{C}$

parameter:  $V_{GS}$

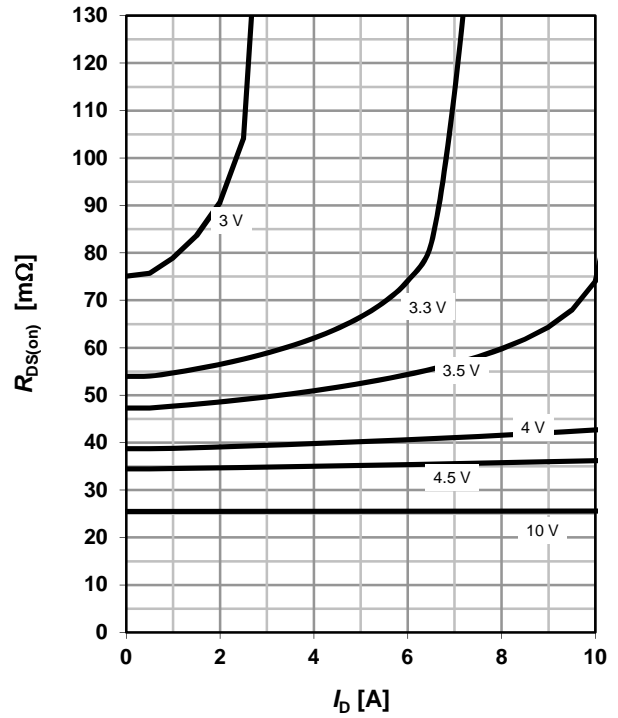

**7 Typ. transfer characteristics**

$I_D=f(V_{GS}); |V_{DS}|>2|I_D|R_{DS(on)max}$

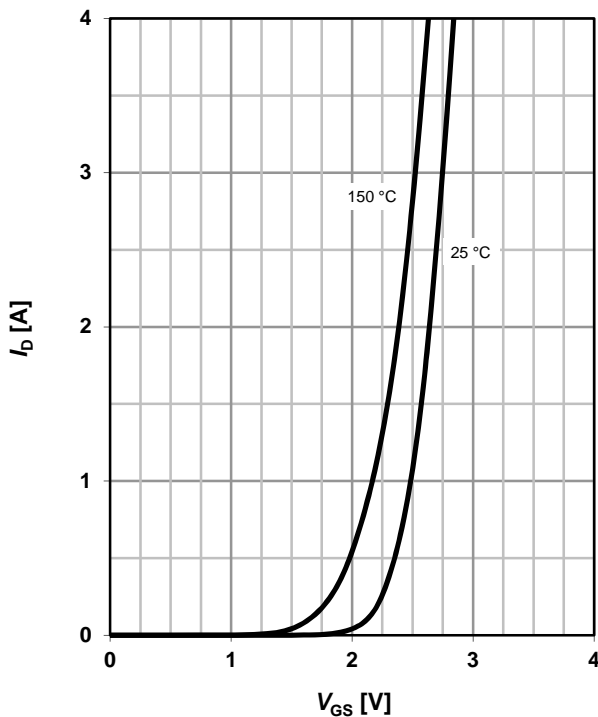

**8 Typ. forward transconductance**

$g_{fs}=f(I_D); T_j=25\text{ }^\circ\text{C}$

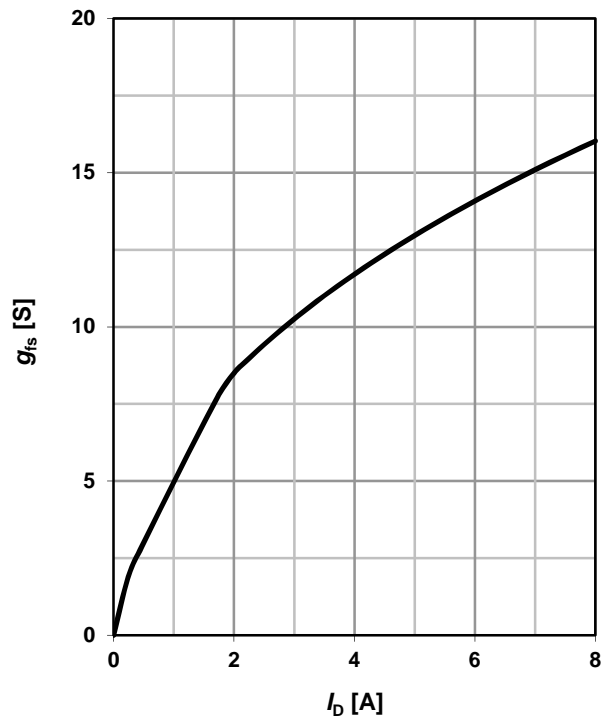

**9 Drain-source on-state resistance**

$R_{DS(on)}=f(T_j)$ ;  $I_D=-6.3$  A;  $V_{GS}=-10$  V

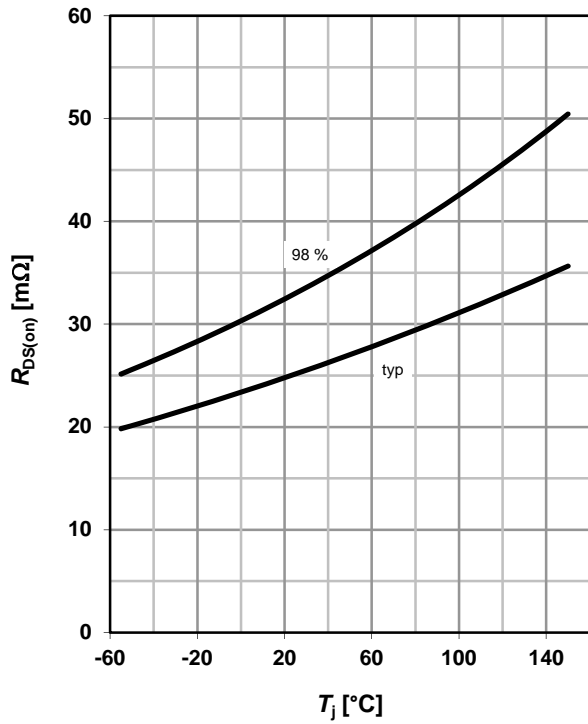

**10 Typ. gate threshold voltage**

$V_{GS(th)}=f(T_j)$ ;  $V_{DS}=V_{GS}$ ;  $I_D=-30$   $\mu$ A

parameter:  $I_D$

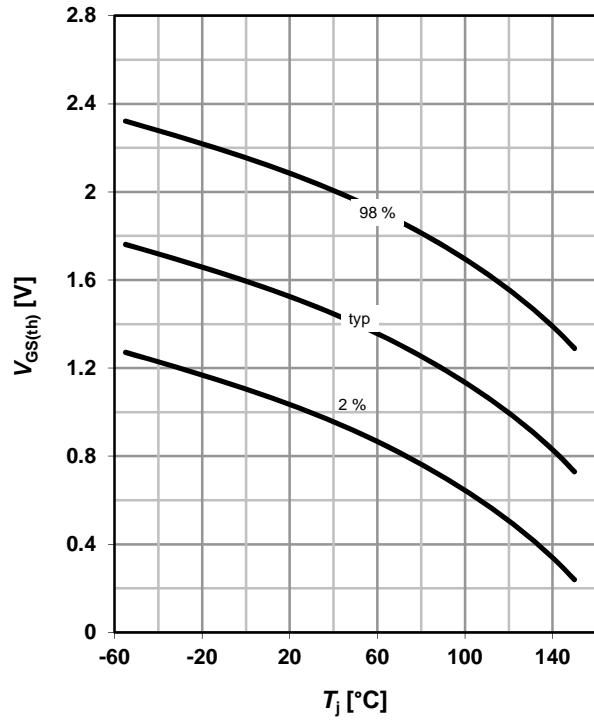

**11 Typ. capacitances**

$C=f(V_{DS})$ ;  $V_{GS}=0$  V;  $f=1$  MHz;  $T_j=25$  °C

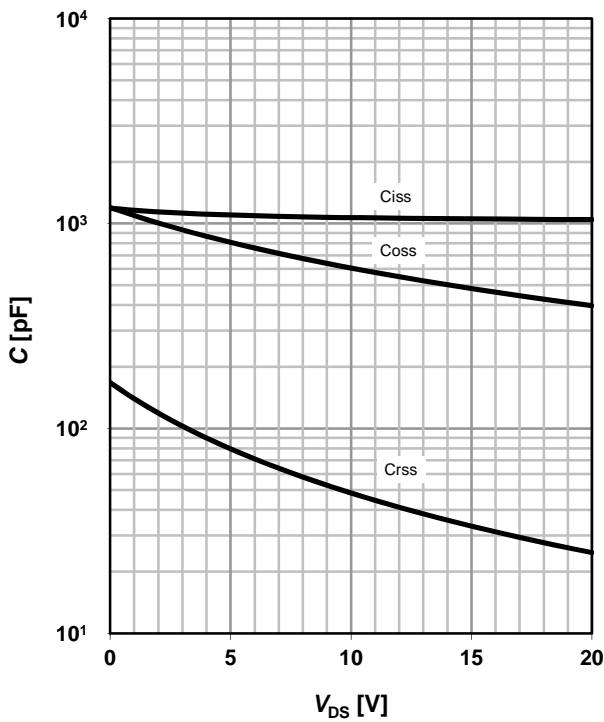

**12 Forward characteristics of reverse diode**

$I_F=f(V_{SD})$

parameter:  $T_j$

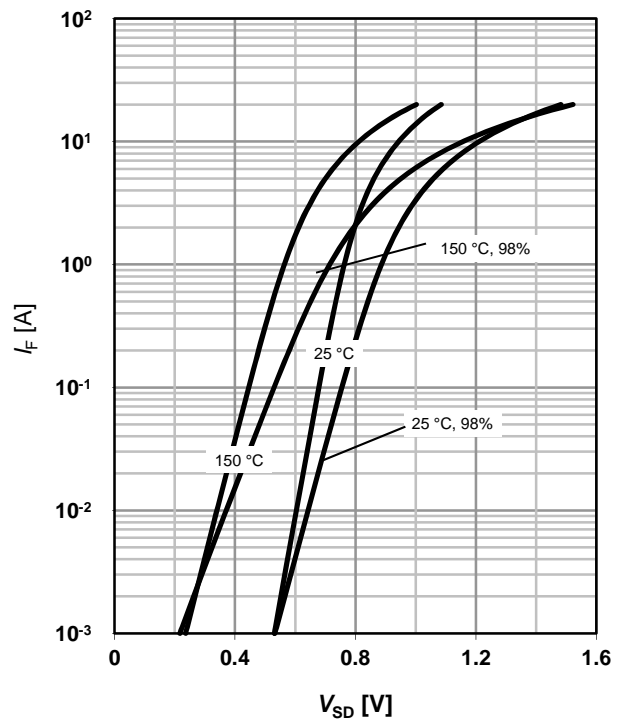

**13 Avalanche characteristics**

$I_{AS}=f(t_{AV}); R_{GS}=25 \Omega$

parameter:  $T_{j(\text{start})}$

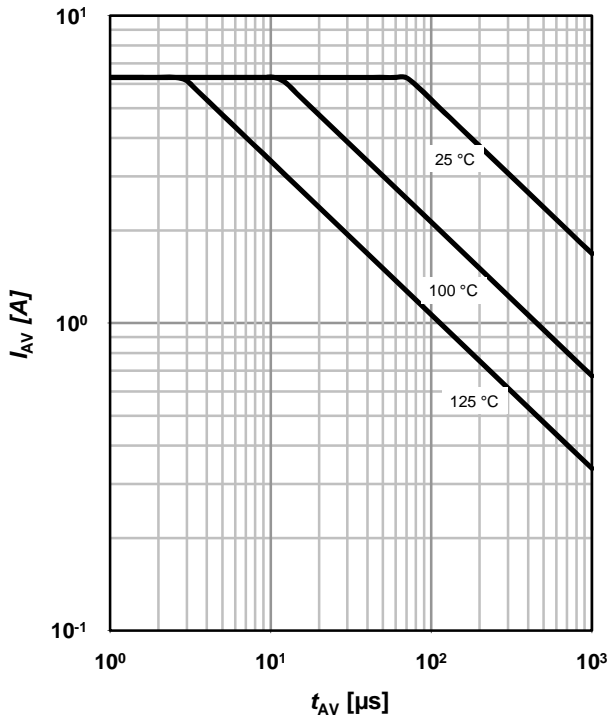

**14 Typ. gate charge**

$V_{GS}=f(Q_{\text{gate}}); I_D=-6.3 \text{ A pulsed}$

parameter:  $V_{DD}$

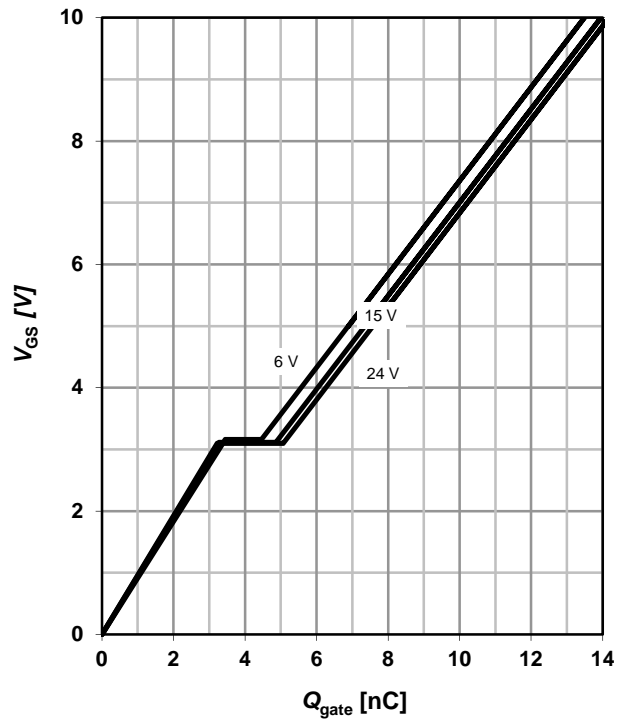

**15 Drain-source breakdown voltage**

$V_{BR(DSS)}=f(T_j); I_D=-250 \mu\text{A}$

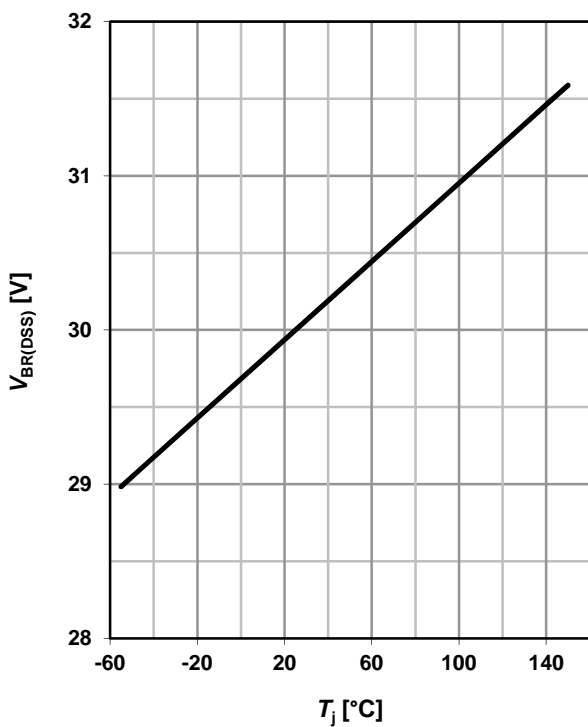

**16 Gate charge waveforms**

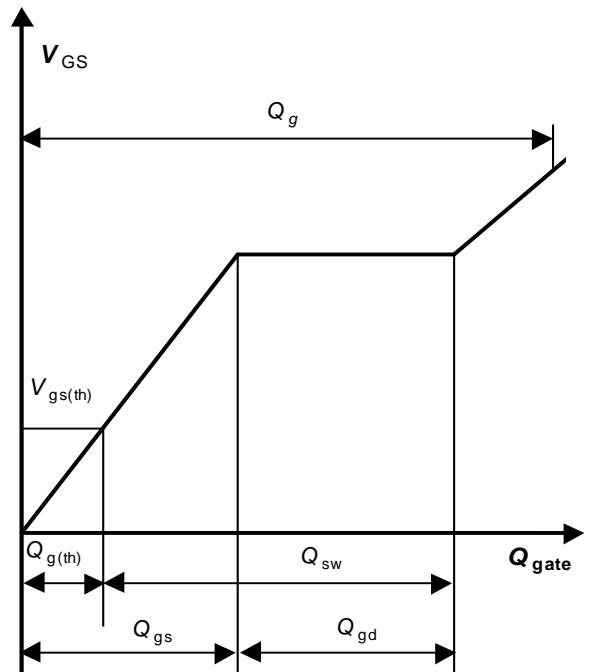



Package Outline:

TSOP-6

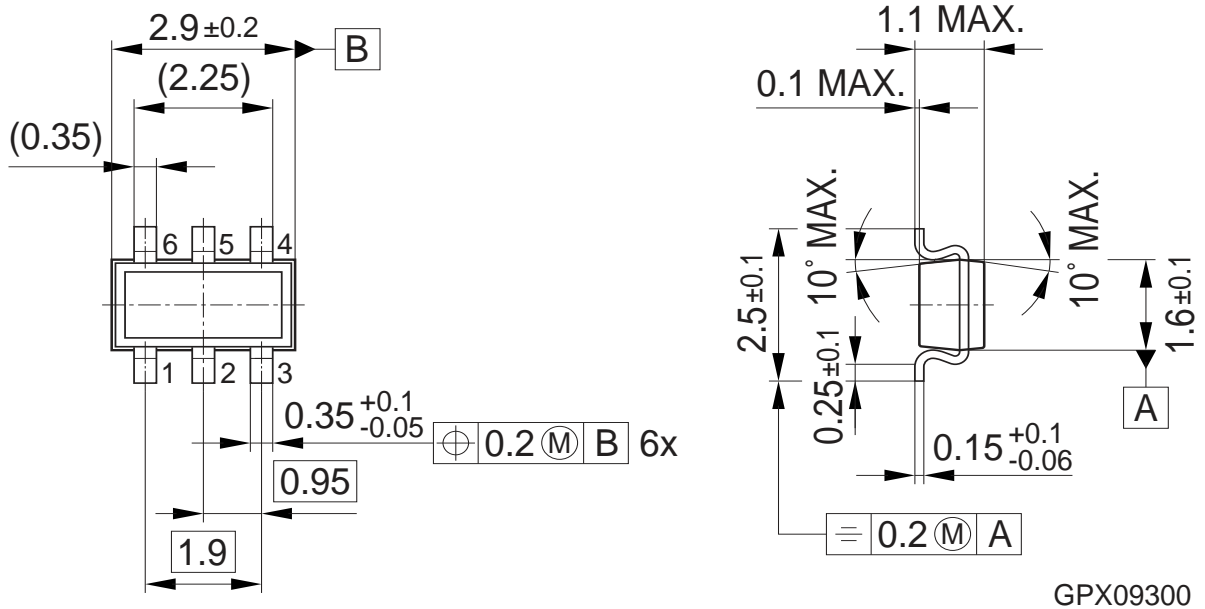

Footprint:

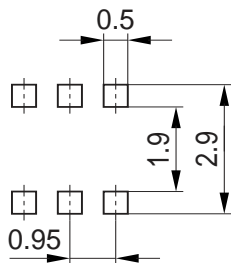

Remark: Wave soldering possible dep. on customers process conditions

HLG09283

Packaging:

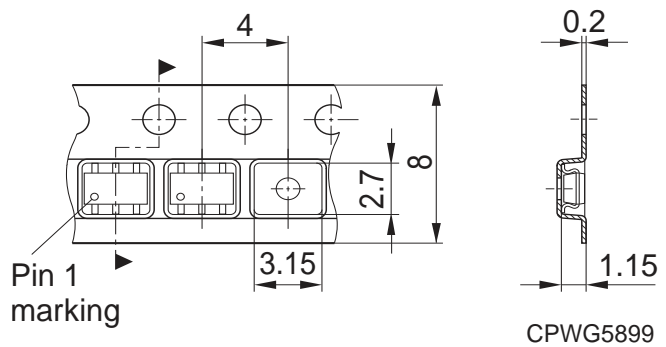

Dimensions in mm

Note: For symmetric types there is no defined Pin 1 orientation in the reel.

## Revision History

BSL303SPE

**Revision: 2014-12-10, Rev. 2.0**

Previous Revision

Revision	Date	Subjects (major changes since last revision)
2.0	2014-12-10	Release of final version

### We Listen to Your Comments

Any information within this document that you feel is wrong, unclear or missing at all? Your feedback will help us to continuously improve the quality of this document. Please send your proposal (including a reference to this document) to:

[erratum@infineon.com](mailto:erratum@infineon.com)

### Published by

**Infineon Technologies AG**

**81726 München, Germany**

**© 2014 Infineon Technologies AG**

**All Rights Reserved.**

### Legal Disclaimer

The information given in this document shall in no event be regarded as a guarantee of conditions or characteristics. With respect to any examples or hints given herein, any typical values stated herein and/or any information regarding the application of the device, Infineon Technologies hereby disclaims any and all warranties and liabilities of any kind, including without limitation, warranties of non-infringement of intellectual property rights of any third party.

### Information

For further information on technology, delivery terms and conditions and prices please contact your nearest Infineon Technologies Office ([www.infineon.com](http://www.infineon.com)).

### Warnings

Due to technical requirements, components may contain dangerous substances. For information on the types in question, please contact the nearest Infineon Technologies Office.

The Infineon Technologies component described in this Data Sheet may be used in life-support devices or systems and/or automotive, aviation and aerospace applications or systems only with the express written approval of Infineon Technologies, if a failure of such components can reasonably be expected to cause the failure of that life-support, automotive, aviation and aerospace device or system or to affect the safety or effectiveness of that device or system. Life support devices or systems are intended to be implanted in the human body or to support and/or maintain and sustain and/or protect human life. If they fail, it is reasonable to assume that the health of the user or other persons may be endangered.