

Order Code	TCK-053
Inductance (each winding)	830 μ H \pm 35% (at 100 kHz / 100 mV)
Impedance (DCR)	31 m Ω max.
Rated Current	3.3 A max.
Rated Voltage	500 VDC max. (between windings)
Operating Temperature	-40°C to +105°C
RoHS Exemptions	No Exemptions

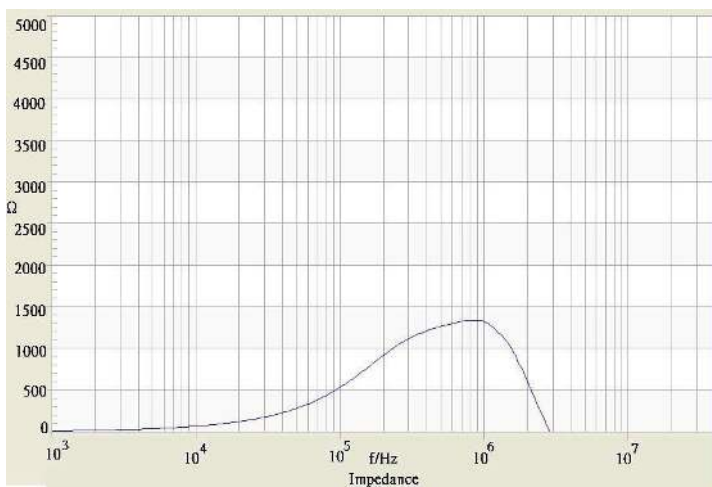

Impedance Curve



Outline Dimensions

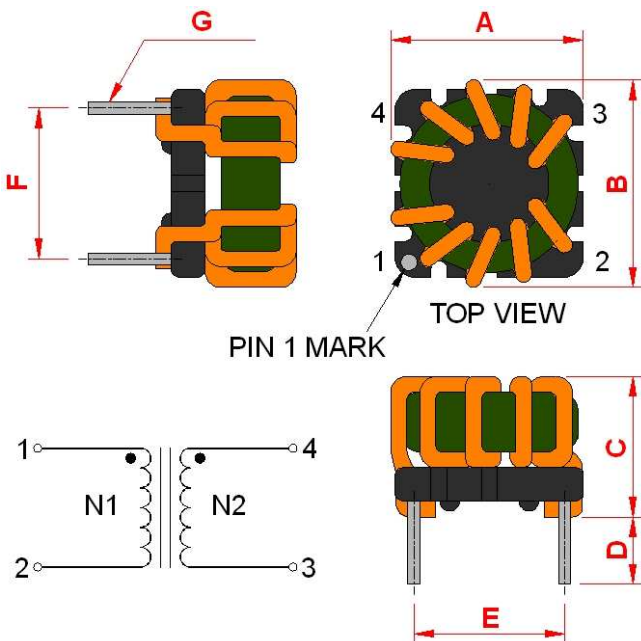

Dimensions [mm]	
A	11.5 max.
B	11.5 max.
C	9.8 max.
D	2.5 min.
E	7.62 \pm 0.2
F	7.62 \pm 0.2
G	\varnothing 0.6 \pm 0.1

All specifications valid at +25°C, unless otherwise stated.