

TDP Series Ultra-miniature Surface Mount Half-pitch Side-Actuated DIP Switches



H
DIP

Features/Benefits

- World's first ultra-miniature SMT half-pitch side-actuated DIP
- Side actuation allows visual indication of on/off position in horizontal applications
- Process sealed for surface mount soldering and washable processing
- RoHS compliant
- Lead free

Typical Applications

- Hand-held electronic devices
- Portable computer and electronic devices
- Instrumentation and controls



Specifications

SWITCH FUNCTION: SPST — 2, 4, 6, 8, 10 positions.

CONTACT RATING:

24 V DC, 25 mA (switching).

50 V DC, 100 mA (steady state).

MECHANICAL AND ELECTRICAL LIFE: 1,000 cycles.

CONTACT RESISTANCE: 100 mΩ max.

INSULATION RESISTANCE: 100 MΩ @ 100 V DC min.

DIELECTRIC STRENGTH: 300 V AC min.

STORAGE TEMPERATURE: -40°C to 85°C.

OPERATING TEMPERATURE: -40°C to 85°C.

OPERATING FORCE: 4.9N max.

SOLDERABILITY: Per MIL-STD-202F method 208D, or

EIA RS-186E method 9 (1 hour steam aging).

PACKAGING: Switches supplied in rigid dispensing tubes in full tube quantities only, this may affect order quantity. Tape and reel packaging also available.

Materials

CASE & COVER: glass filled PPS (UL94V-0).

ACTUATOR: PA6T (UL94V-0).

CONTACTS: Copper alloy with gold plate over nickel plate.

TERMINALS: Copper alloy, with gold over nickel plate.

All terminals are insert molded.

TAPE SEAL: Polyimide.

Note: Specifications and materials listed above are for switches with standard options. For information on specific and custom switches, consult Customer Service Center.

How To Order

The Build-A Switch concept allows you to mix and match options to create the switch you need. Below is a complete listing of options shown in catalog. To order, simply select desired option from each category and place in the appropriate box.

All switches supplied in "OFF" position.

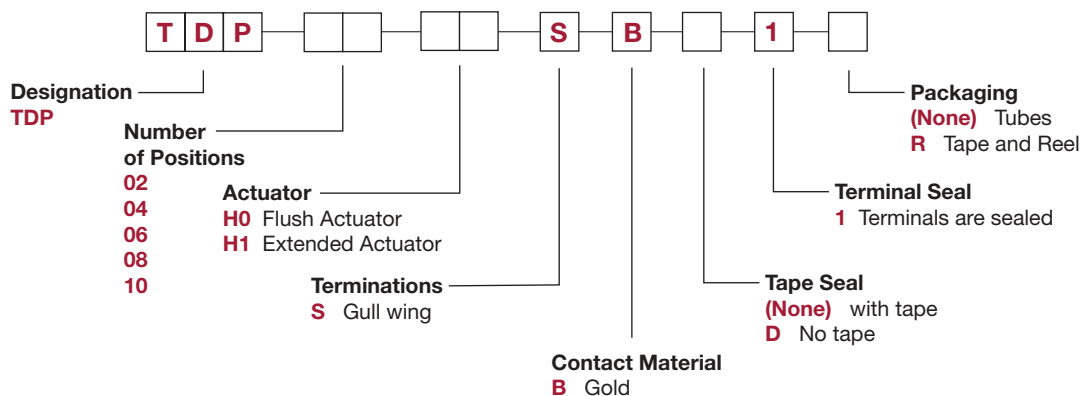

Note: Tape seal is not available with H1 Extended Actuators.



Dimensions are shown: Inch (mm)
Specifications and dimensions subject to change



TDP Series Ultra-miniature Surface Mount Half-pitch Side-Actuated DIP Switches



DIP H

Flush Actuator-No Top Tape, Surface Mount Terminals

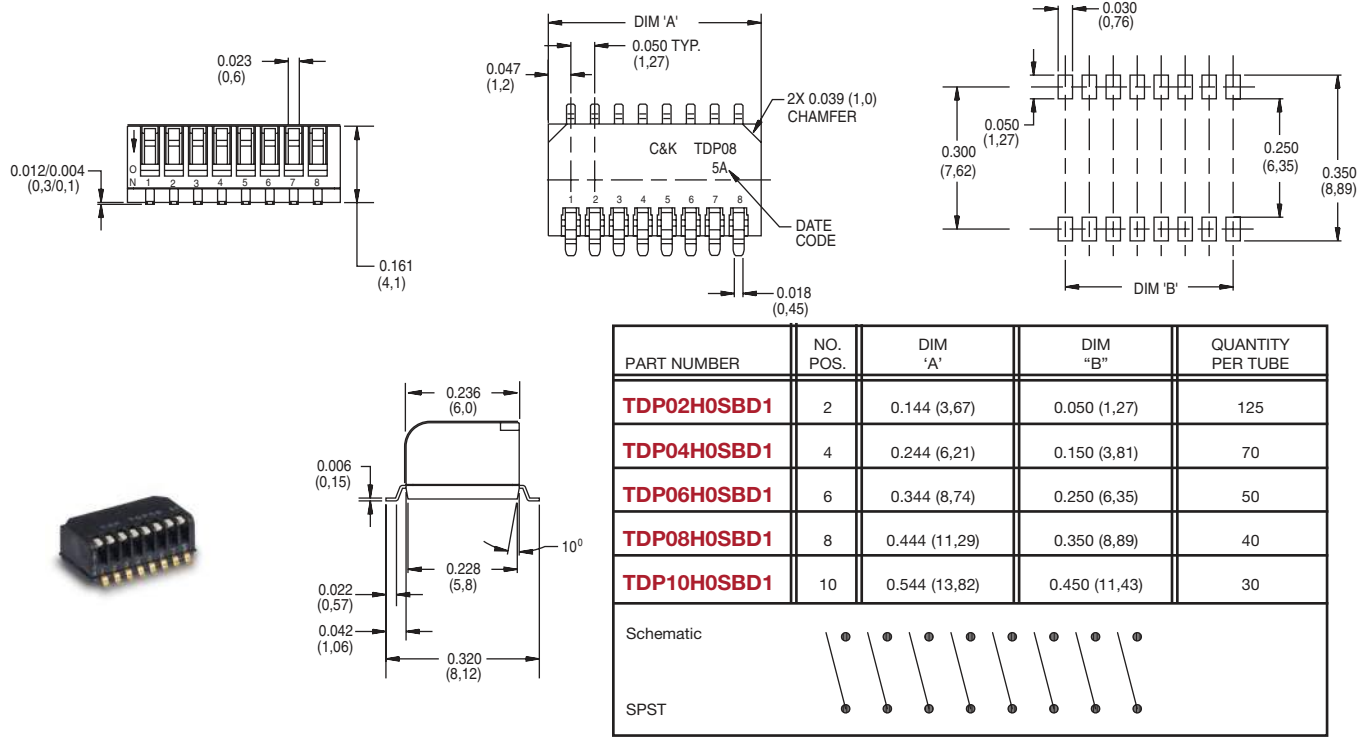

Flush Actuator-with Top Tape, Surface Mount Terminals

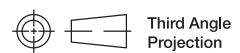
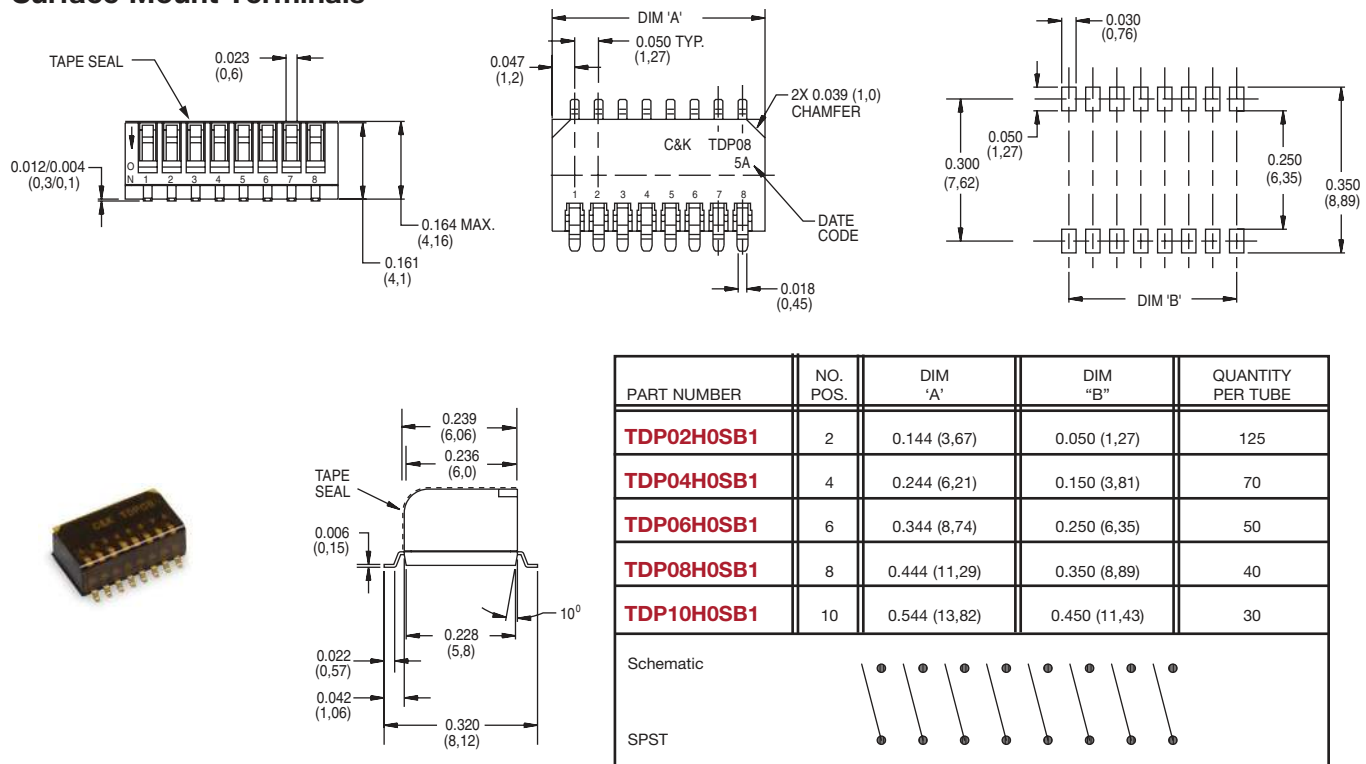

Dimensions are shown: Inch (mm)
Specifications and dimensions subject to change

TDP Series Ultra-miniature Surface Mount Half-pitch Side-Actuated DIP Switches



H DIP

Extended Actuator-No Top Tape, Surface Mount Terminals

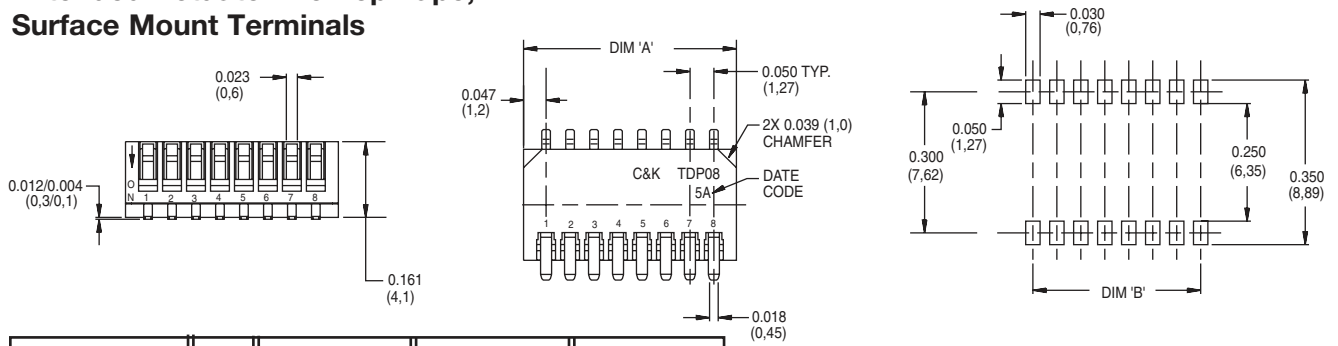

PART NUMBER	NO. POS.	DIM 'A'	DIM 'B'	QUANTITY PER TUBE
TDP02H1SBD1	2	0.144 (3,67)	0.050 (1,27)	125
TDP04H1SBD1	4	0.244 (6,21)	0.150 (3,81)	70
TDP06H1SBD1	6	0.344 (8,74)	0.250 (6,35)	50
TDP08H1SBD1	8	0.444 (11,29)	0.350 (8,89)	40
TDP10H1SBD1	10	0.544 (13,82)	0.450 (11,43)	30

Schematic:

SPST

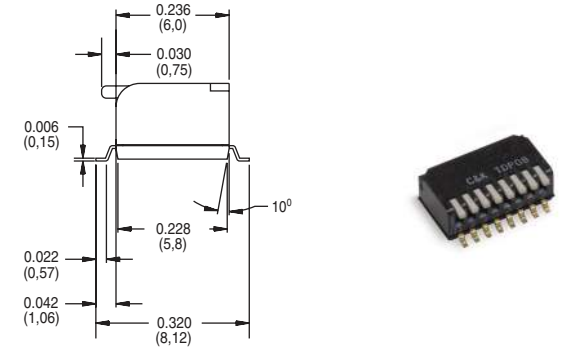

Tube Packaging

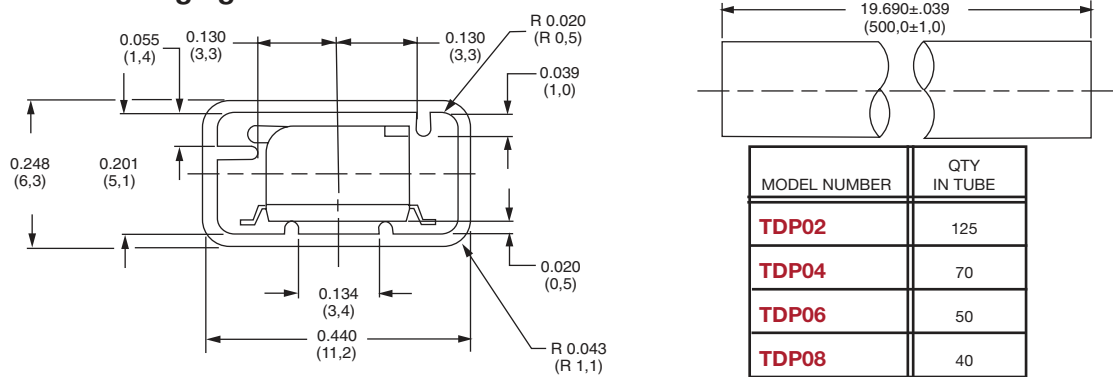

MODEL NUMBER	QTY IN TUBE
TDP02	125
TDP04	70
TDP06	50
TDP08	40
TDP10	30

Note: Switch shown has H1 extended actuator.

Tape and Reel Packaging

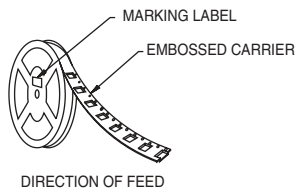

DIM PART NUMBER	DIM. 'W'	DIM 'P'	PER REEL
TDP02	0.630 (16,0)	0.175 (4,45)	1,000
TDP04	0.630 (16,0)	0.276 (7,0)	1,000
TDP06	0.630 (16,0)	0.376 (9,55)	1,000
TDP08	0.945 (24,0)	0.476 (12,1)	1,000
TDP10	0.945 (24,0)	0.576 (14,65)	1,000

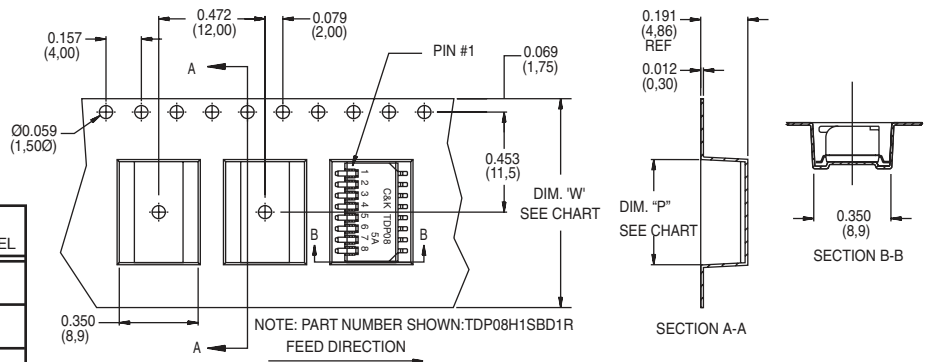

Dimensions are shown: Inch (mm)
Specifications and dimensions subject to change

