

1-967622-5 ✓ ACTIVE

AMP | Junior Power Timer

TE Internal #: 1-967622-5

Housing for Female Terminals, Wire-to-Wire, 12 Position, .197 in [5 mm] Centerline, Gray, Wire & Cable, Power, Junior Power Timer

[View on TE.com >](#)



Connectors > Automotive Connectors > Automotive Housings > Timer Connector Housing



Connector & Housing Type: **Housing for Female Terminals**

Mating Tab Width: **2.8 mm [.11 in]**

Connector System: **Wire-to-Wire**

Number of Positions: **12**

Centerline (Pitch): **5 mm [.197 in]**

[All Timer Connector Housing \(589\)](#)

Features

Product Type Features

Connector Shape	Rectangular
Connector & Housing Type	Housing for Female Terminals
Connector System	Wire-to-Wire
Sealable	No
Hybrid Connector	No
Primary Locking Feature	On the Terminal
Connector & Contact Terminates To	Wire & Cable

Configuration Features

Number of Positions	12
Number of Rows	3

Electrical Characteristics

Nominal Voltage Architecture	28 V
------------------------------	------

Body Features

Primary Product Color	Gray
Connector & Keying Code	A

Contact Features

Contact Size	2.8mm
--------------	-------



Contact Type	Receptacle
--------------	------------

Mating Tab Width	2.8 mm[.11 in]
------------------	----------------

Mechanical Attachment

Terminal Position Assurance	Yes
-----------------------------	-----

Strain Relief	Without
---------------	---------

Mating Alignment Type	Keyed
-----------------------	-------

Mating Alignment	With
------------------	------

Connector Mounting Type	Cable Mount (Free-Hanging)
-------------------------	----------------------------

Housing Features

Housing Material	PBT GF
------------------	--------

Centerline (Pitch)	5 mm[.197 in]
--------------------	---------------

Dimensions

Connector Height	26.5 mm[1.043 in]
------------------	-------------------

Product Width	21.2 mm[.835 in]
---------------	------------------

Product Length	21.2 mm[.835 in]
----------------	------------------

Operation/Application

Circuit Application	Power
---------------------	-------

Packaging Features

Packaging Method	Carton
------------------	--------

Other

Serviceable	No
-------------	----

Connector Position Assurance Capable	No
--------------------------------------	----

Product Compliance

[For compliance documentation, visit the product page on TE.com>](#)

EU RoHS Directive 2011/65/EU	Compliant
------------------------------	-----------

EU ELV Directive 2000/53/EC	Compliant
-----------------------------	-----------

China RoHS 2 Directive MIIT Order No 32, 2016	No Restricted Materials Above Threshold
---	---

EU REACH Regulation (EC) No. 1907/2006	Current ECHA Candidate List: JUNE 2023 (235) Candidate List Declared Against: JUNE 2023 (235) Does not contain REACH SVHC
--	---







Halogen Content	Low Halogen - Br, Cl, F, I < 900 ppm per homogenous material. Also BFR/CFR/PVC Free
Solder Process Capability	Not applicable for solder process capability



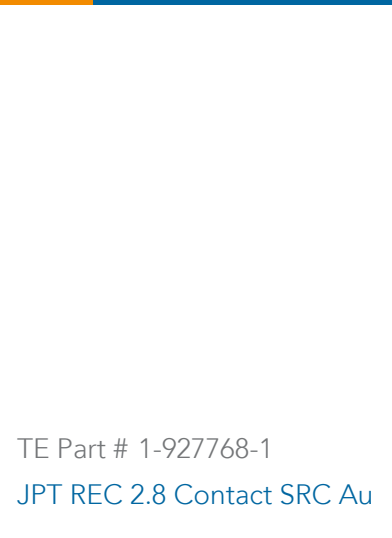

Product Compliance Disclaimer

This information is provided based on reasonable inquiry of our suppliers and represents our current actual knowledge based on the information they provided. This information is subject to change. The part numbers that TE has identified as EU RoHS compliant have a maximum concentration of 0.1% by weight in homogenous materials for lead, hexavalent chromium, mercury, PBB, PBDE, DBP, BBP, DEHP, DIBP, and 0.01% for cadmium, or qualify for an exemption to these limits as defined in the Annexes of Directive 2011/65/EU (RoHS2). Finished electrical and electronic equipment products will be CE marked as required by Directive 2011/65/EU. Components may not be CE marked. Additionally, the part numbers that TE has identified as EU ELV compliant have a maximum concentration of 0.1% by weight in homogenous materials for lead, hexavalent chromium, and mercury, and 0.01% for cadmium, or qualify for an exemption to these limits as defined in the Annexes of Directive 2000/53/EC (ELV). Regarding the REACH Regulation, the information TE provides on SVHC in articles for this part number is based on the latest European Chemicals Agency (ECHA) 'Guidance on requirements for substances in articles' posted at this URL: <https://echa.europa.eu/guidance-documents/guidance-on-reach>

Compatible Parts

 <p>TE Part # 967632-1 2. KONT-SICHERUNG 12P</p>	 <p>TE Part # CAT-AM705-CH8173 AMP MCP Unsealed Connector Housings</p>	 <p>TE Part # CAT-T4827-T273 TIMER, RECEPTACLE AND TAB</p>	 <p>TE Part # 1719810-1 JPT REC 2.8 Contact SRC Sn</p>
 <p>TE Part # 1-927768-1 JPT REC 2.8 Contact SRC Au</p>			

Also in the Series | Junior Power Timer

 <p>Automotive Connector Caps & Covers (5)</p>	 <p>Automotive Housings(252)</p>	 <p>Automotive Terminals(86)</p>	 <p>Busbars & Terminals(1)</p>
---	---	---	---

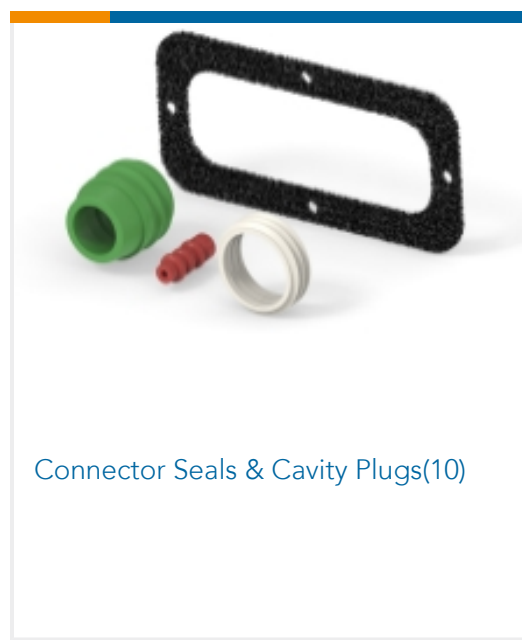

Connector Seals & Cavity Plugs(10)

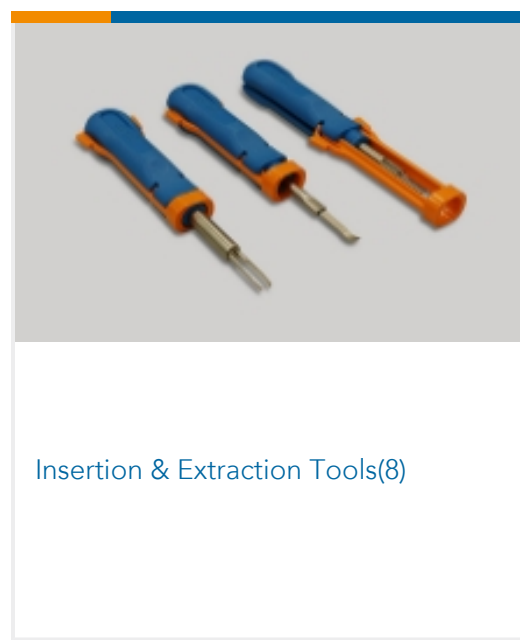

Insertion & Extraction Tools(8)



Module Components(6)

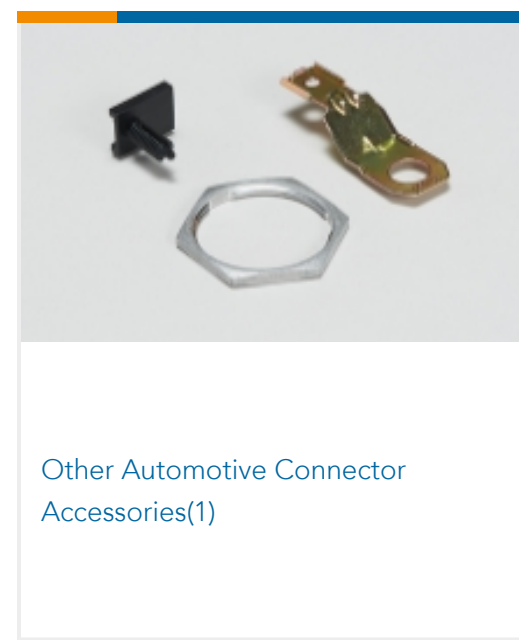

Other Automotive Connector Accessories(1)



PCB Headers & Receptacles(1)

Customers Also Bought



TE Part #1-967625-2
Timer Connector Housing

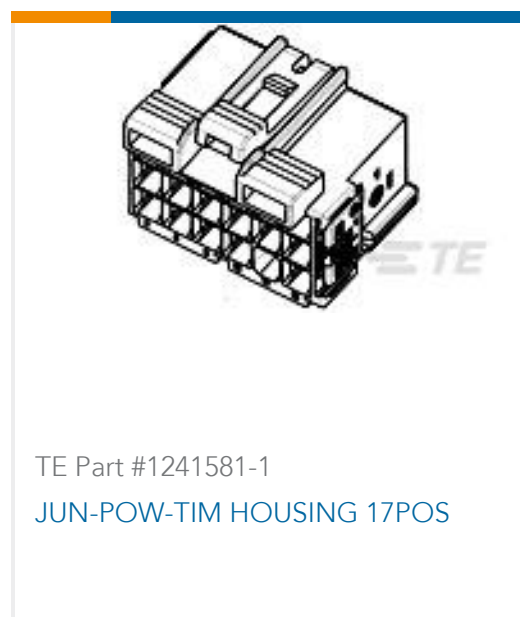

TE Part #1241581-1
JUN-POW-TIM HOUSING 17POS

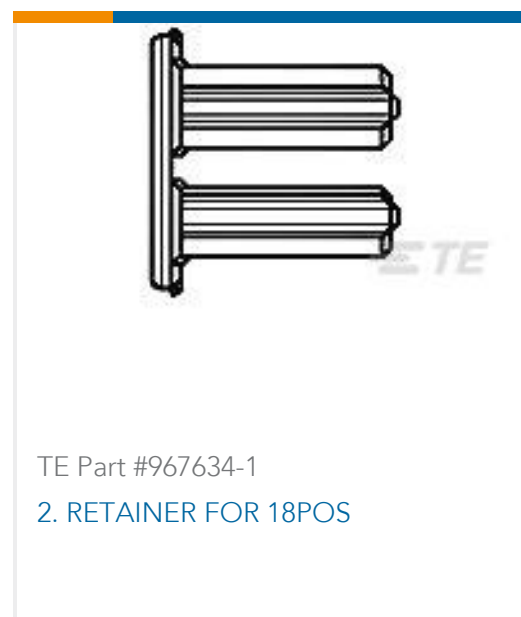

TE Part #967634-1
2. RETAINER FOR 18POS



TE Part #K1163730
Emergency switch ES-2003-T412-020C

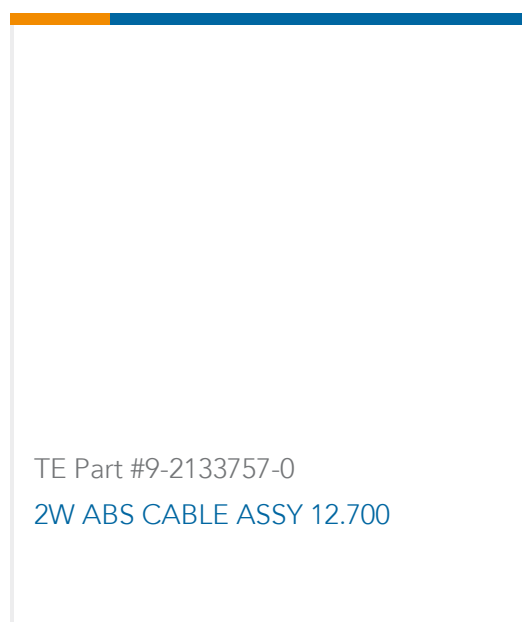

TE Part #9-2133757-0
2W ABS CABLE ASSY 12.700

Documents

Product Drawings

JUN-POW-TIM GEH 12P

English

CAD Files

Customer View Model

[ENG_CVM_1-967622-5_D.3d_igs.zip](#)

English

Customer View Model



[ENG_CVM_1-967622-5_D.3d_stp.zip](#)

English

Customer View Model

[ENG_CVM_1-967622-5_D.2d_dxf.zip](#)

English

3D PDF

English

By downloading the CAD file I accept and agree to the [Terms and Conditions](#) of use.

Datasheets & Catalog Pages

Timer Interconnection System

English

Product Specifications

Product Specification

English

Product Specification

English