

## GTLP18T612

### 18-Bit LVTTTL/GTLP Universal Bus Transceiver

#### General Description

The GTLP18T612 is an 18-bit universal bus transceiver which provides LVTTTL to GTLP signal level translation. It allows for transparent, latched and clocked modes of data transfer. The device provides a high speed interface for cards operating at LVTTTL logic levels and a backplane operating at GTLP logic levels. High speed backplane operation is a direct result of GTLP's reduced output swing (< 1V), reduced input threshold levels and output edge rate control. The edge rate control minimizes bus settling time. GTLP is a Fairchild Semiconductor derivative of the Gunning Transistor logic (GTL) JEDEC standard JESD8-3.

Fairchild's GTLP has internal edge-rate control and is Process, Voltage, and Temperature (PVT) compensated. Its function is similar to BTL or GTL but with different output levels and receiver thresholds. GTLP output LOW level is less than 0.5V, the output HIGH is 1.5V and the receiver threshold is 1.0V.

#### Features

- Bidirectional interface between GTLP and LVTTTL logic levels
- Designed with edge rate control circuitry to reduce output noise on the GTLP port
- V<sub>REF</sub> pin provides external supply reference voltage for receiver threshold adjustability
- Special PVT compensation circuitry to provide consistent performance over variations of process, supply voltage and temperature
- TTL compatible driver and control inputs
- Designed using Fairchild advanced BiCMOS technology
- Bushold data inputs on A port to eliminate the need for external pull-up resistors for unused inputs
- Power up/down and power off high impedance for live insertion
- Open drain on GTLP to support wired-or connection
- Flow through pinout optimizes PCB layout
- D-type flip-flop, latch and transparent data paths
- A Port source/sink -24mA/+24mA
- B Port sink +50mA
- Also packaged in plastic Fine-Pitch Ball Grid Array (FBGA)

#### Ordering Code:

Order Number	Package Number	Package Description
GTLP18T612G (Note 1)(Note 2)	BGA54A	54-Ball Fine-Pitch Ball Grid Array (FBGA), JEDEC MO-205, 5.5mm Wide
GTLP18T612MEA (Note 2)	MS56A	56-Lead Shrink Small Outline Package (SSOP), JEDEC MO-118, 0.300" Wide
GTLP18T612MTD (Note 2)	MTD56	56-Lead Thin Shrink Small Outline Package (TSSOP), JEDEC MO-153, 6.1mm Wide

**Note 1:** Ordering code "G" indicates Trays.

**Note 2:** Device also available in Tape and Reel. Specify by appending suffix letter "X" to the ordering code.

## Connection Diagrams

**Pin Assignments for SSOP and TSSOP**

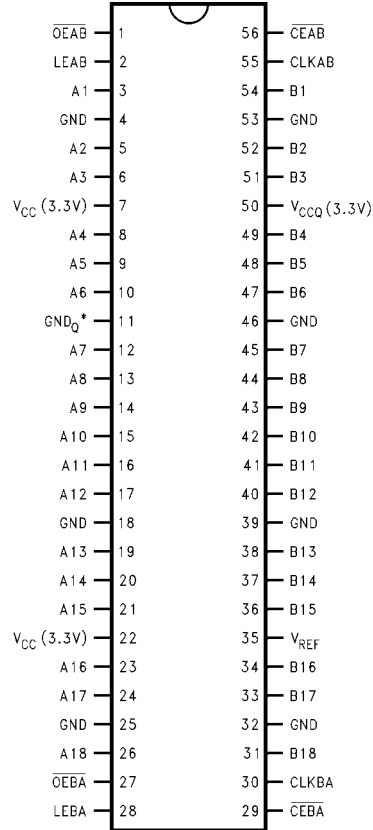

**Pin Assignments for FBGA**

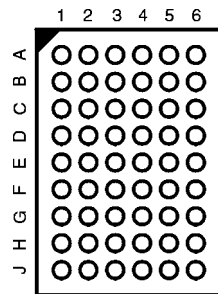

(Top Thru View)

## Pin Descriptions

Pin Names	Description
$\overline{OEAB}$	A-to-B Output Enable (Active LOW) (LVTTTL Level)
$\overline{OEBA}$	B-to-A Output Enable (Active LOW) (LVTTTL Level)
$\overline{CEAB}$	A-to-B Clock/LE Enable (Active LOW) (LVTTTL Level)
$\overline{CEBA}$	B-to-A Clock/LE Enable (Active LOW) (LVTTTL Level)
LEAB	A-to-B Latch Enable (Transparent HIGH) (LVTTTL Level)
LEBA	B-to-A Latch Enable (Transparent HIGH) (LVTTTL Level)
$V_{REF}$	GTLP Input Threshold Reference Voltage
CLKAB	A-to-B Clock (LVTTTL Level)
CLKBA	B-to-A Clock (LVTTTL Level)
A1–A18	A-to-B Data Inputs or B-to-A 3-STATE Outputs
B1–B18	B-to-A Data Inputs or A-to-B Open Drain Outputs

## FBGA Pin Assignments

	1	2	3	4	5	6
<b>A</b>	A <sub>2</sub>	A <sub>1</sub>	OEAB	CLKAB	B <sub>2</sub>	B <sub>1</sub>
<b>B</b>	A <sub>4</sub>	A <sub>3</sub>	LEAB	CEAB	B <sub>4</sub>	B <sub>3</sub>
<b>C</b>	A <sub>6</sub>	A <sub>5</sub>	V <sub>CC</sub>	V <sub>CC</sub>	B <sub>6</sub>	B <sub>5</sub>
<b>D</b>	A <sub>8</sub>	A <sub>7</sub>	GND	GND	B <sub>8</sub>	B <sub>7</sub>
<b>E</b>	A <sub>10</sub>	A <sub>9</sub>	GND	GND	B <sub>10</sub>	B <sub>9</sub>
<b>F</b>	A <sub>12</sub>	A <sub>11</sub>	GND	GND	B <sub>12</sub>	B <sub>11</sub>
<b>G</b>	A <sub>14</sub>	A <sub>13</sub>	V <sub>CC</sub>	V <sub>REF</sub>	B <sub>14</sub>	B <sub>13</sub>
<b>H</b>	A <sub>16</sub>	A <sub>15</sub>	OEBA	CEBA	B <sub>16</sub>	B <sub>15</sub>
<b>J</b>	A <sub>18</sub>	A <sub>17</sub>	LEBA	CLKBA	B <sub>18</sub>	B <sub>17</sub>

### Functional Description

The GTLP18T612 is an 18 bit registered transceiver containing D-type flip-flop, latch and transparent modes of operation for the data path. Data flow in each direction is controlled by the clock enables ( $\overline{CEAB}$  and  $\overline{CEBA}$ ), latch enables ( $LEAB$  and  $LEBA$ ), clock ( $CLKAB$  and  $CLKBA$ ) and output enables ( $\overline{OEAB}$  and  $\overline{OEBA}$ ). The clock enables ( $\overline{CEAB}$  and  $\overline{CEBA}$ ) and the output enables ( $\overline{OEAB}$  and  $\overline{OEBA}$ ) control the 18 bits of data for the A-to-B and B-to-A directions respectively.

For A-to-B data flow, when  $\overline{CEAB}$  is LOW, the device operates on the LOW-to-HIGH transition of  $CLKAB$  for the flip-flop and on the HIGH-to-LOW transition of  $LEAB$  for the latch path. That is, if  $\overline{CEAB}$  is LOW and  $LEAB$  is LOW the A data is latched regardless as to the state of  $CLKAB$  (HIGH or LOW) and if  $LEAB$  is HIGH the device is in transparent mode. When  $\overline{OEAB}$  is LOW the outputs are active. When  $\overline{OEAB}$  is HIGH the outputs are HIGH impedance. The data flow of B-to-A is similar except that  $\overline{CEBA}$ ,  $\overline{OEBA}$ ,  $LEBA$ , and  $CLKBA$  are used.

### Truth Table

(Note 3)

Inputs					Output	Mode
$\overline{CEAB}$	$\overline{OEAB}$	$LEAB$	$CLKAB$	A	B	
X	H	X	X	X	Z	Latched
L	L	L	H	X	$B_0$ (Note 4)	Storage of A Data
L	L	L	L	X	$B_0$ (Note 5)	
X	L	H	X	L	L	Transparent
X	L	H	X	H	H	
L	L	L	↑	L	L	Clocked Storage of A Data
L	L	L	↑	H	H	
H	L	L	X	X	$B_0$ (Note 5)	Clock Inhibit

**Note 3:** A-to-B data flow is shown. B-to-A data flow is similar but uses  $\overline{OEBA}$ ,  $LEBA$ ,  $CLKBA$ , and  $\overline{CEBA}$ .

**Note 4:** Output level before the indicated steady state input conditions were established, provided that  $CLKAB$  was HIGH before  $LEAB$  went LOW.

**Note 5:** Output level before the indicated steady-state input conditions were established.

### Logic Diagram

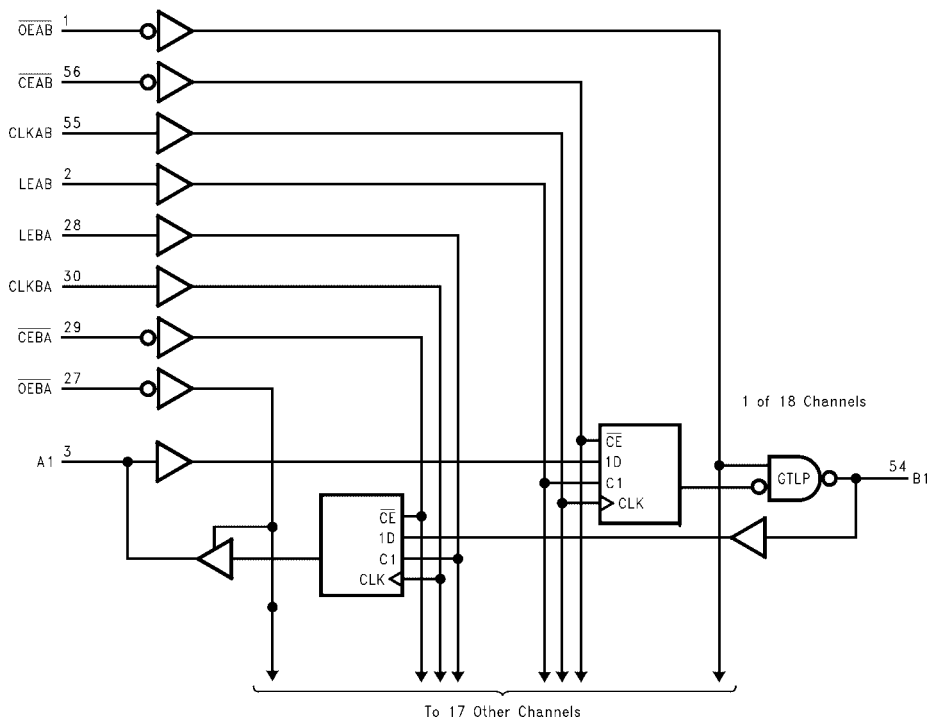

### Absolute Maximum Ratings (Note 6)

Supply Voltage ( $V_{CC}$ )	-0.5V to +4.6V
DC Input Voltage ( $V_I$ )	-0.5V to +4.6V
DC Output Voltage ( $V_O$ )	
Outputs 3-STATE	-0.5V to +4.6V
Outputs Active (Note 7)	-0.5V to $V_{CC} + 0.5V$
DC Output Sink Current into	
A Port $I_{OL}$	48 mA
DC Output Source Current from	
A Port $I_{OH}$	-48 mA
DC Output Sink Current into	
B Port in the LOW State, $I_{OL}$	100 mA
DC Input Diode Current ( $I_{IK}$ )	
$V_I < 0V$	-50 mA
DC Output Diode Current ( $I_{OK}$ )	
$V_O < 0V$	-50 mA
$V_O > V_{CC}$	+50 mA
ESD Performance	>2000V
Storage Temperature ( $T_{STG}$ )	-65°C to +150°C

### Recommended Operating Conditions (Note 8)

Supply Voltage $V_{CC}/V_{CCQ}$	3.15V to 3.45V
Bus Termination Voltage ( $V_{TT}$ )	
GTLP	1.47V to 1.53V
$V_{REF}$	0.98V to 1.02V
Input Voltage ( $V_I$ )	
on A Port and Control Pins	0.0V to 3.45V
on B Port	0.0V to 3.45V
HIGH Level Output Current ( $I_{OH}$ )	
A Port	-24 mA
LOW Level Output Current ( $I_{OL}$ )	
A Port	+24 mA
B Port	+50 mA
Operating Temperature ( $T_A$ )	-40°C to +85°C

**Note 6:** Absolute Maximum continuous ratings are those values beyond which damage to the device may occur. Exposure to these conditions or conditions beyond those indicated may adversely affect device reliability. Functional operation under absolute maximum rated conditions is not implied.

**Note 7:**  $I_O$  Absolute Maximum Rating must be observed.

**Note 8:** Unused inputs must be held HIGH or LOW.

### DC Electrical Characteristics

Over Recommended Operating Free-Air Temperature Range,  $V_{REF} = 1.0V$  (unless otherwise noted).

Symbol		Test Conditions		Min	Typ (Note 9)	Max	Units
$V_{IH}$	B Port			$V_{REF} + 0.05$		$V_{TT}$	V
	Others			2.0			
$V_{IL}$	B Port			0.0		$V_{REF} - 0.05$	V
	Others					0.8	
$V_{REF}$	GTLP (Note 10)				1.0		V
	GTL				0.8		
$V_{IK}$		$V_{CC} = 3.15V$	$I_I = -18 mA$			-1.2	V
$V_{OH}$	A Port	$V_{CC}, V_{CCQ} = \text{Min to Max (Note 11)}$	$I_{OH} = -100 \mu A$	$V_{CC} - 0.2$			V
		$V_{CC} = 3.15V$	$I_{OH} = -8 mA$	2.4			
		$V_{CC} = 3.15V$	$I_{OH} = -24 mA$	2.0			
$V_{OL}$	A Port	$V_{CC}, V_{CCQ} = \text{Min to Max (Note 11)}$	$I_{OL} = 100 \mu A$			0.2	V
		$V_{CC} = 3.15V$	$I_{OL} = 24 mA$			0.5	
	B Port	$V_{CC} = 3.15V$	$I_{OL} = 40 mA$			0.40	V
		$V_{CC} = 3.15V$	$I_{OL} = 50 mA$			0.55	
$I_I$	Control Pins	$V_{CC} = \text{Min to Max (Note 11)}$	$V_I = 3.45V \text{ or } 0V$			$\pm 5$	$\mu A$
	A Port	$V_{CC} = 3.45V$	$V_I = 0V$			-10	
	B Port	$V_{CC} = 3.45V$	$V_I = 3.45V$			10	
$I_{OFF}$	A Port	$V_{CC} = 3.45V$	$V_I = V_{CC}$			5	$\mu A$
			$V_I = 0$			-5	
$I_{OFF}$	A Port and Control Pins	$V_{CC} = 0$	$V_I \text{ or } V_O = 0 \text{ to } 3.45V$			30	$\mu A$
$I_{I(\text{hold})}$	A Port	$V_{CC} = 3.15V$	$V_I = 0.8V$	75			$\mu A$
			$V_I = 2.0V$			-75	
$I_{OZH}$	A Port	$V_{CC} = 3.45V$	$V_O = 3.45V$			10	$\mu A$
	B Port		$V_O = 1.5V$			5	
$I_{OZL}$	A Port	$V_{CC} = 3.45V$	$V_O = 0V$			-10	$\mu A$
	B Port		$V_O = 0.55V$			-5	
$I_{CC}$ ( $V_{CC}/V_{CCQ}$ )	A or B Ports	$V_{CC} = 3.45V$ $I_O = 0$ $V_I = V_{CC} \text{ or } GND$	Outputs HIGH		30	40	mA
			Outputs LOW		30	40	
			Outputs Disabled		30	45	

DC Electrical Characteristics (Continued)							
Symbol		Test Conditions		Min	Typ (Note 9)	Max	Units
$\Delta I_{CC}$ (Note 12)	A Port and Control Pins	$V_{CC} = 3.45V$ , A or Control Inputs at $V_{CC}$ or GND	One Input at 2.7V		0	2	mA
$C_i$	Control Pins		$V_i = V_{CC}$ or 0		6		pF
	A Port		$V_i = V_{CC}$ or 0		7.5		
	B Port		$V_i = V_{CC}$ or 0		9.0		
<p><b>Note 9:</b> All typical values are at <math>V_{CC} = 3.3V</math>, <math>V_{CCQ} = 3.3V</math>, and <math>T_A = 25^\circ C</math>.</p> <p><b>Note 10:</b> GTLP <math>V_{REF}</math> and <math>V_{TT}</math> are specified to 2% tolerance since signal integrity and noise margin can be significantly degraded if these supplies are noisy. In addition, <math>V_{TT}</math> and <math>R_{term}</math> can be adjusted beyond the recommended operating conditions to accommodate backplane impedances other than 50Ω, but must remain within the boundaries of the DC Absolute Maximum ratings. Similarly <math>V_{REF}</math> can be adjusted to optimize noise margin.</p> <p><b>Note 11:</b> For conditions shown as Min or Max, use the appropriate value specified under recommended operating conditions.</p> <p><b>Note 12:</b> This is the increase in supply current for each input that is at the specified TTL voltage level rather than <math>V_{CC}</math> or GND.</p>							
AC Operating Requirements							
Over recommended ranges of supply voltage and operating free-air temperature, $V_{REF} = 1.0V$ (unless otherwise noted).							
Symbol		Test Conditions		Min	Max	Unit	
$f_{MAX}$	Maximum Clock Frequency			175		MHz	
$t_{WIDTH}$	Pulse Duration	LEAB or LEBA HIGH		3.0		ns	
		CLKAB or CLKBA HIGH or LOW		3.0			
$t_{SU}$	Setup Time	A before CLKAB↑		1.1		ns	
		B before CLKBA↑		3.0			
		A before LEAB		1.1			
		B before LEBA		2.7			
		CEAB before CLKAB↑		1.2			
		CEBA before CLKBA↑		1.4			
$t_{HOLD}$	Hold Time	A after CLKAB↑		0.0		ns	
		B after CLKBA↑		0.0			
		A after LEAB		0.8			
		B after LEBA		0.0			
		CEAB after CLKAB↑		1.0			
		CEBA after CLKBA↑		1.9			

### AC Electrical Characteristics

Over recommended range of supply voltage and operating free-air temperature,  $V_{REF} = 1.0V$  (unless otherwise noted).  
 $C_L = 30$  pF for B Port and  $C_L = 50$  pF for A Port.

Symbol	From (Input)	To (Output)	Min	Typ (Note 13)	Max	Unit
$t_{PLH}$ $t_{PHL}$	A	B	2.1 1.0	4.1 2.7	6.3 4.4	ns
$t_{PLH}$ $t_{PHL}$	LEAB	B	2.2 1.0	4.2 2.4	6.3 4.2	ns
$t_{PLH}$ $t_{PHL}$	CLKAB	B	2.2 1.0	4.4 2.5	6.5 4.4	ns
$t_{PLH}$ $t_{PHL}$	$\overline{OEAB}$	B	2.0 1.0	3.8 2.6	5.6 4.3	ns
$t_{RISE}$	Transition Time, B Outputs (20% to 80%)			3.1		ns
$t_{FALL}$	Transition Time, B Outputs (20% to 80%)			2.1		
$t_{PLH}$ $t_{PHL}$	B	A	1.8 1.8	3.8 3.8	5.8 5.8	ns
$t_{PLH}$ $t_{PHL}$	LEBA	A	0.3 0.4	2.2 2.4	4.6 4.6	ns
$t_{PLH}$ $t_{PHL}$	CLKBA	A	0.5 0.6	2.4 2.6	4.6 4.6	ns
$t_{PZH}, t_{PZL}$ $t_{PHZ}, t_{PLZ}$	$\overline{OEBA}$	A	0.3 0.3	2.7 2.5	5.2 5.2	ns

**Note 13:** All typical values are at  $V_{CC} = 3.3V$ , and  $T_A = 25^\circ C$ .

### Extended Electrical Characteristics

Over recommended ranges of supply voltage and operating free-air temperature  $V_{REF} = 1.0V$  (unless otherwise noted).  
 $C_L = 30$  pF for B Port and  $C_L = 50$  pF for A Port.

Symbol	From (Input)	To (Output)	Min	Typ (Note 13)	Max	Unit
$t_{OSLH}$ (Note 14)	A	B		0.8	1.0	ns
$t_{OSHL}$ (Note 14)	A	B		0.3	0.5	ns
$t_{PV(HL)}$ (Note 15)(Note 16)	A	B			0.8	ns
$t_{OSLH}$ (Note 14)	CLKAB	B		0.9	1.0	ns
$t_{OSHL}$ (Note 14)	CLKAB	B		0.3	0.5	ns
$t_{PV(HL)}$ (Note 15)(Note 16)	CLKAB	B			0.8	ns
$t_{OSLH}$ (Note 14)	B	A		0.7	1.0	ns
$t_{OSHL}$ (Note 14)	B	A		0.6	1.0	ns
$t_{OST}$ (Note 14)	B	A		0.7	1.1	ns
$t_{PV}$ (Note 15)	B	A			1.5	ns
$t_{OSLH}$ (Note 14)	CLKAB	A		0.5	1.0	ns
$t_{OSHL}$ (Note 14)	CLKAB	A		0.6	1.0	ns
$t_{OST}$ (Note 14)	CLKAB	A		1.1	1.2	ns
$t_{PV}$ (Note 15)	CLKAB	A			1.5	ns

**Note 14:**  $t_{OSHL}/t_{OSLH}$  and  $t_{OST}$  - Output to output skew is defined as the absolute value of the difference between the actual propagation delay for all outputs within the same packaged device. The specifications are given for specific worst case  $V_{CC}$  and temperature and apply to any outputs switching in the same direction either HIGH-to-LOW ( $t_{OSHL}$ ) or LOW-to-HIGH ( $t_{OSLH}$ ) or in opposite directions both HL and LH ( $t_{OST}$ ). This parameter is guaranteed by design and statistical process distribution. Actual skew values between the GTLP outputs could vary on the backplane due to the loading and impedance seen by the device.

**Note 15:**  $t_{PV}$  - Part to part skew is defined as the absolute value of the difference between the actual propagation delay for all outputs from device to device. The parameter is specified for a specific worst case  $V_{CC}$  and temperature. This parameter is guaranteed by design and statistical process distribution. Actual skew values between the GTLP outputs could vary on the backplane due to the loading and impedance seen by the device.

**Note 16:** Due to the open drain structure on GTLP outputs  $t_{OST}$  and  $t_{PV(LH)}$  in the A-to-B direction are not specified. Skew on these paths is dependent on the  $V_{TT}$  and  $R_T$  values on the backplane.

## Test Circuits and Timing Waveforms

**Test Circuit for A Outputs**

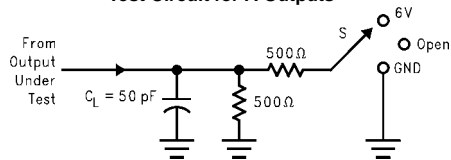

Test	S
$t_{PLH}/t_{PHL}$	Open
$t_{PLZ}/t_{PZL}$	6V
$t_{PHZ}/t_{PZH}$	GND

**Note A:**  $C_L$  includes probes and Jig capacitance.

**Test Circuit for B Outputs**

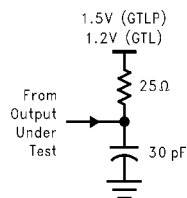

**Note B:** For B Port,  $C_L = 30$  pF is used for worst case.

**Voltage Waveform - Propagation Delay Times**

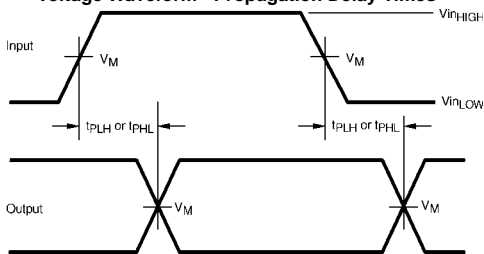

**Voltage Waveform - Setup and Hold Times**

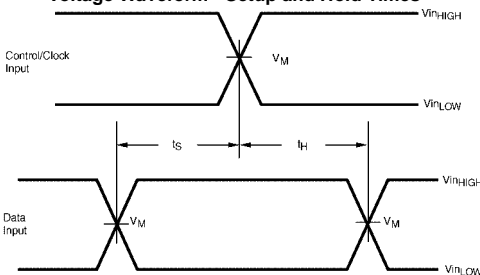

**Voltage Waveform - Pulse Width**

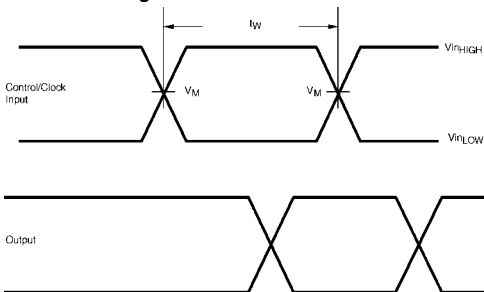

**Voltage Waveform - Enable and Disable times**

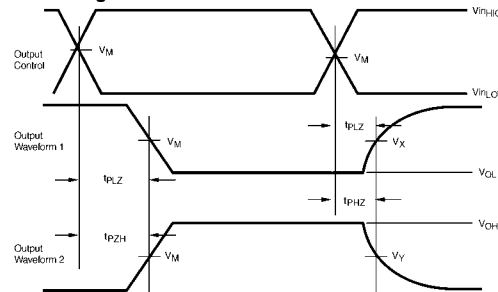

Output Waveform 1 is for an output with internal conditions such that the output is LOW except when disabled by the control output.  
Output Waveform 2 is for an output with internal conditions such that the output is HIGH except when disabled by the control output.

**Input and Measure Conditions**

	A or LVTTL Pins	B or GTLP Pins
$V_{inHIGH}$	3.0	1.5
$V_{inLOW}$	0.0	0.0
$V_M$	1.5	1.0
$V_X$	$V_{OL} + 0.3V$	N/A
$V_Y$	$V_{OH} - 0.3V$	N/A

All input pulses have the following characteristics: Frequency = 10MHz,  $t_{RISE} = t_{FALL} = 2$  ns (10% to 90%),  $Z_O = 50\Omega$ . The outputs are measured one at a time with one transition per measurement.

**Physical Dimensions** inches (millimeters) unless otherwise noted

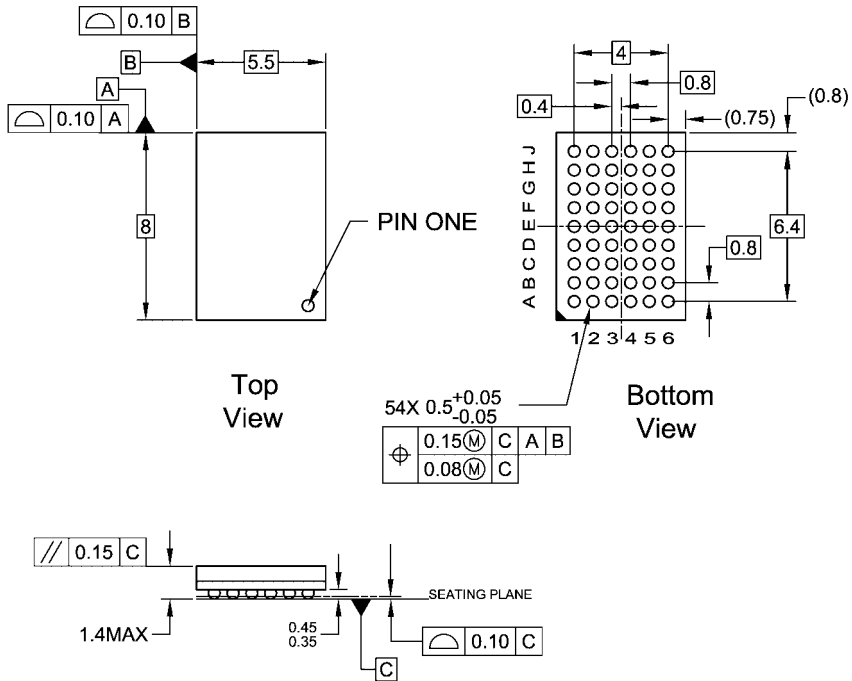

- NOTES:
- A. THIS PACKAGE CONFORMS TO JEDEC M0-205
  - B. ALL DIMENSIONS IN MILLIMETERS
  - C. LAND PATTERN RECOMMENDATION: NSMD (Non Solder Mask Defined)  
.35MM DIA PADS WITH A SOLDERMASK OPENING OF .45MM CONCENTRIC TO PADS
  - D. DRAWING CONFORMS TO ASME Y14.5M-1994

BGA54ArevD

**54-Ball Fine-Pitch Ball Grid Array (FBGA), JEDEC MO-205, 5.5mm Wide  
Package Number BGA54A**



**Physical Dimensions** inches (millimeters) unless otherwise noted (Continued)

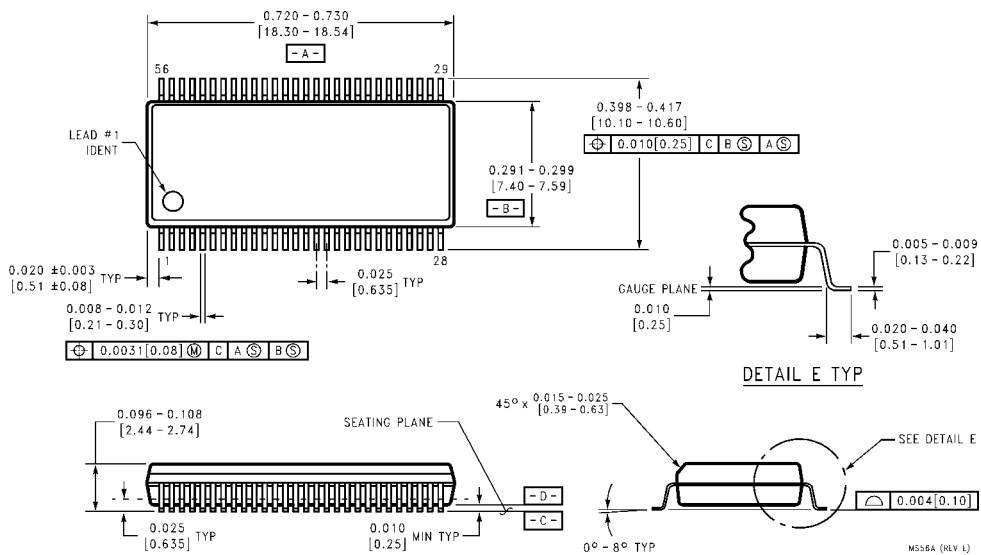

**56-Lead Shrink Small Outline Package (SSOP), JEDEC MO-118, 0.300" Wide  
Package Number MS56A**

**Physical Dimensions** inches (millimeters) unless otherwise noted (Continued)

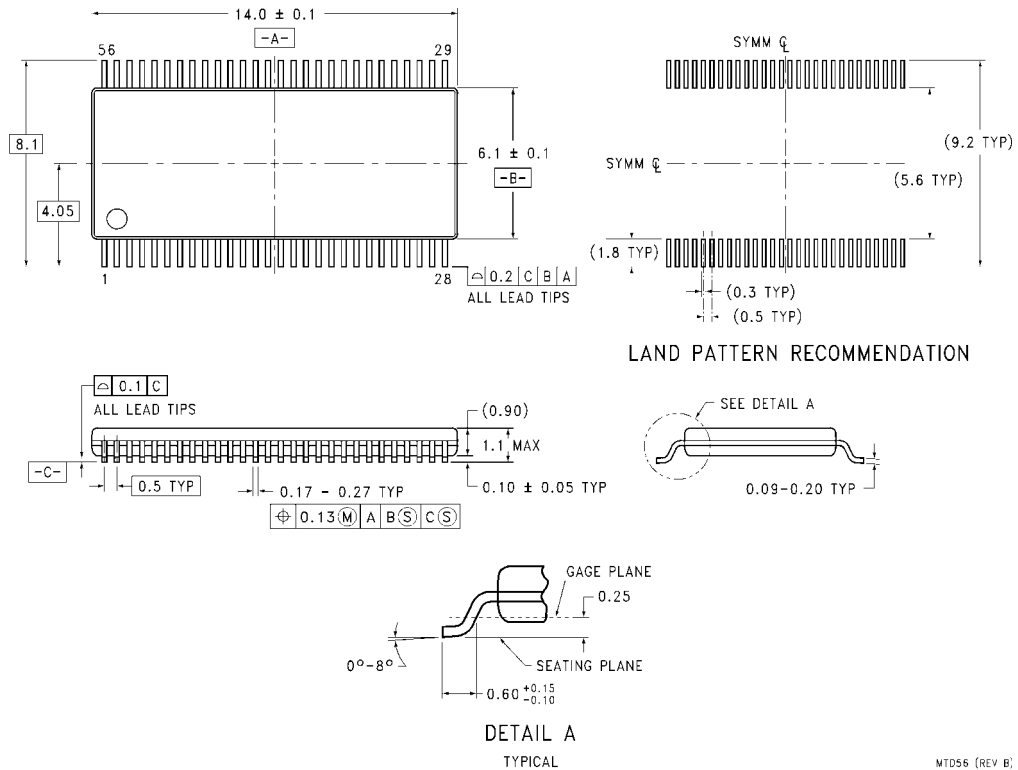

**56-Lead Thin Shrink Small Outline Package (TSSOP), JEDEC MO-153, 6.1mm Wide  
Package Number MTD56**

Fairchild does not assume any responsibility for use of any circuitry described, no circuit patent licenses are implied and Fairchild reserves the right at any time without notice to change said circuitry and specifications.

**LIFE SUPPORT POLICY**

FAIRCHILD'S PRODUCTS ARE NOT AUTHORIZED FOR USE AS CRITICAL COMPONENTS IN LIFE SUPPORT DEVICES OR SYSTEMS WITHOUT THE EXPRESS WRITTEN APPROVAL OF THE PRESIDENT OF FAIRCHILD SEMICONDUCTOR CORPORATION. As used herein:

1. Life support devices or systems are devices or systems which, (a) are intended for surgical implant into the body, or (b) support or sustain life, and (c) whose failure to perform when properly used in accordance with instructions for use provided in the labeling, can be reasonably expected to result in a significant injury to the user.
2. A critical component in any component of a life support device or system whose failure to perform can be reasonably expected to cause the failure of the life support device or system, or to affect its safety or effectiveness.

[www.fairchildsemi.com](http://www.fairchildsemi.com)