

# IS31AP4066D

## DUAL 1.3W STEREO AUDIO AMPLIFIER

September 2021

### GENERAL DESCRIPTION

The IS31AP4066D is a dual bridge-connected audio power amplifier which, when connected to a 5V supply, will deliver 1.3W to an 8Ω load.

The IS31AP4066D features a low-power consumption shutdown mode and thermal shutdown protection. It also utilizes circuitry to reduce “click-and-pop” during device turn-on.

### APPLICATIONS

- Cell phones, PDA, MP4, PMP
- Portable and desktop computers
- Desktops audio system
- Multimedia monitors

### KEY SPECIFICATIONS

- $P_o$  at  $R_L = 8\Omega$ ,  $V_{CC} = 5V$   
 THD+N = 1% ----- 1.3W (Typ.)  
 THD+N = 10% ----- 1.6W (Typ.)
- $P_o$  at  $R_L = 8\Omega$ ,  $V_{CC} = 4V$   
 THD+N = 1% ----- 0.81W (Typ.)
- Shutdown current ----- 0.3μA (Typ.)
- Supply voltage range ----- 2.7V ~ 5.5V
- QFN-16 (3mm × 3mm) package

### FEATURES

- Suppress “click-and-pop”
- Thermal shutdown protection circuitry
- Micro power shutdown mode

### TYPICAL APPLICATION CIRCUIT

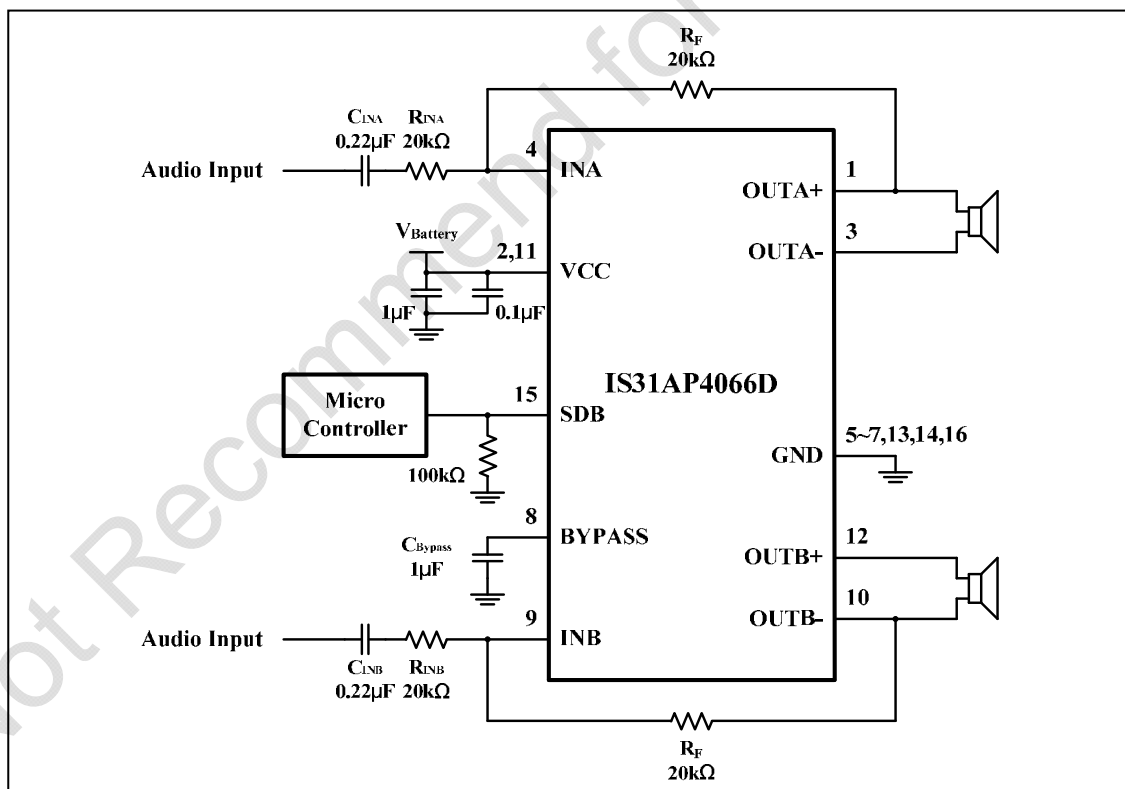
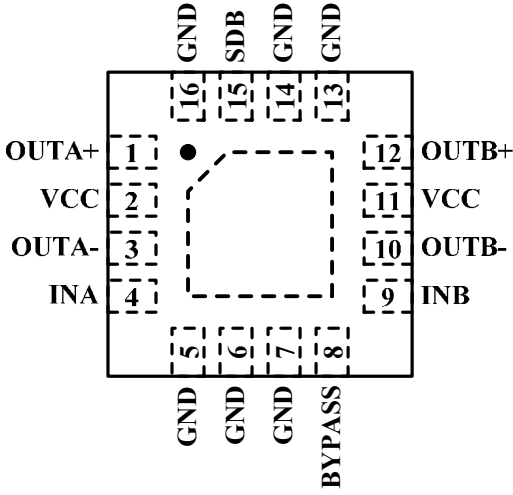

Figure 1 Typical Application Circuit

# IS31AP4066D

## PIN CONFIGURATION

Package	Pin Configuration (Top View)
QFN-16	

## PIN DESCRIPTION

No.	Pin	Description
1	OUTA+	Left channel positive output.
2,11	VCC	Supply voltage.
3	OUTA-	Left channel negative output.
4	INA	Left channel input.
5~7,13,14,16	GND	Ground.
8	BYPASS	Bypass capacitor which provides the common mode voltage.
9	INB	Right channel input.
10	OUTB-	Right channel negative output.
12	OUTB+	Right channel positive output.
15	SDB	Shutdown control, hold low for shutdown mode.
	Thermal Pad	Connect to GND.

# IS31AP4066D

## ORDERING INFORMATION

Industrial Range: -40°C to +85°C

Order Part No.	Package	QTY/Reel
IS31AP4066D-QFLS2-TR	QFN-16, Lead-free	2500

Not Recommend for New Design

Copyright © 2021 Lumissil Microsystems. All rights reserved. Lumissil Microsystems reserves the right to make changes to this specification and its products at any time without notice. Lumissil Microsystems assumes no liability arising out of the application or use of any information, products or services described herein. Customers are advised to obtain the latest version of this device specification before relying on any published information and before placing orders for products.

Lumissil Microsystems does not recommend the use of any of its products in life support applications where the failure or malfunction of the product can reasonably be expected to cause failure of the life support system or to significantly affect its safety or effectiveness. Products are not authorized for use in such applications unless Lumissil Microsystems receives written assurance to its satisfaction, that:

- a.) the risk of injury or damage has been minimized;
- b.) the user assume all such risks; and
- c.) potential liability of Lumissil Microsystems is adequately protected under the circumstances

# IS31AP4066D

## ABSOLUTE MAXIMUM RATINGS

Supply voltage, $V_{CC}$	-0.3V ~ +6.0V
Voltage at any input pin	-0.3V ~ $V_{CC}+0.3V$
Maximum junction temperature, $T_{JMAX}$	+150°C
Storage temperature range, $T_{STG}$	-65°C ~ +150°C
Operating temperature range, $T_A$	-40°C ~ +85°C
ESD (HBM)	±1kV
ESD (CDM)	±1kV

**Note:** Stresses beyond those listed under "Absolute Maximum Ratings" may cause permanent damage to the device. These are stress ratings only and functional operation of the device at these or any other condition beyond those indicated in the operational sections of the specifications is not implied. Exposure to absolute maximum rating conditions for extended periods may affect device reliability.

## ELECTRICAL CHARACTERISTICS

The following specifications apply for  $V_{CC}=5V$ , unless otherwise noted.

Limits apply for  $T_A = 25^\circ C$ . (Note 1 or specified)

Symbol	Parameter	Condition	Min.	Typ.	Max.	Unit
$V_{CC}$	Supply voltage		2.7		5.5	V
$I_{CC}$	Quiescent power supply current	$V_{IN} = 0V, I_O = 0A$		3.9	10.0	mA
$I_{SD}$	Shutdown current	GND applied to the shutdown pin		0.3	2.5	μA
$V_{IH}$	Shutdown input voltage high		1.4			V
$V_{IL}$	Shutdown input voltage low				0.4	V
$t_{WU}$	Turn on time	$C_{Bypass} = 1\mu F$ (Note 2)		120		ms

## ELECTRICAL CHARACTERISTICS OPERATION

The following specifications apply for  $V_{CC}=5V$ , unless otherwise noted.

Limits apply for  $T_A = 25^\circ C$ . (Note 2 or specified)

Symbol	Parameter	Condition	Min.	Typ.	Max.	Unit
$V_{OS}$	Output offset voltage	$V_{IN} = 0V$		5.0	25.0	mV
$P_O$	Output power	THD+N = 1%, $f = 1kHz, R_L = 8\Omega$		1.3		W
		THD+N = 10%, $f = 1kHz, R_L = 8\Omega$		1.6		W
THD+N	Total harmonic distortion +noise	$f = 1kHz, A_v = 2, R_L = 8\Omega, P_O = 1W$		0.1		%
PSRR	Power supply rejection ratio	Input floating, 217Hz, $V_{Ripple} = 200mV_{p-p}$ $C_{Bypass} = 1\mu F, R_L = 8\Omega$		80.0		dB
		Input floating 1kHz, $V_{Ripple} = 200mV_{p-p}$ $C_{Bypass} = 1\mu F, R_L = 8\Omega$		70.0		dB
		Input GND 217Hz, $V_{Ripple} = 200mV_{p-p}$ $C_{Bypass} = 1\mu F, R_L = 8\Omega$		60.0		dB
		Input GND 1kHz $V_{Ripple} = 200mV_{p-p}$ $C_{Bypass} = 1\mu F, R_L = 8\Omega$		60.0		dB
$X_{Talk}$	Channel separation	$f = 1kHz, C_{Bypass} = 1\mu F$		-100		dB
$V_{NO}$	Output noise voltage	1kHz, A-weighted		7.0		μV

# IS31AP4066D

## ELECTRICAL CHARACTERISTICS

The following specifications apply for  $V_{CC} = 3V$ , unless otherwise noted.

Limits apply for  $T_A = 25^\circ C$ . (Note 1 or specified)

Symbol	Parameter	Condition	Min.	Typ.	Max.	Unit
$I_{CC}$	Quiescent power supply current	$V_{IN} = 0V, I_O = 0A$		2.6	6.5	mA
$I_{SD}$	Shutdown current	GND applied to the shutdown pin		0.1	2.2	$\mu A$
$V_{IH}$	Shutdown input voltage high		1.1			V
$V_{IL}$	Shutdown input voltage low				0.4	V
$t_{WU}$	Turn on time	$C_{Bypass} = 1\mu F$ (Note 2)		110		ms

## ELECTRICAL CHARACTERISTICS OPERATION

The following specifications apply for  $V_{CC} = 3V$ , unless otherwise noted.

Limits apply for  $T_A = 25^\circ C$ . (Note 2 or specified)

Symbol	Parameter	Condition	Min.	Typ.	Max.	Unit
$V_{OS}$	Output offset voltage	$V_{IN} = 0V$		2.5	25.0	mV
$P_O$	Output power	THD+N = 1%, $f = 1kHz, R_L = 8\Omega$		0.5		W
		THD+N = 10%, $f = 1kHz, R_L = 8\Omega$		0.6		W
THD+N	Total harmonic distortion+noise	$f = 1kHz, A_V = 2, R_L = 8\Omega, P_O = 0.3W$		0.1		%
PSRR	Power supply rejection ratio	Input floating, 217Hz, $V_{Ripple} = 200mV_{p-p}$ $C_{Bypass} = 1\mu F, R_L = 8\Omega$		75.0		dB
		Input floating 1kHz, $V_{Ripple} = 200mV_{p-p}$ $C_{Bypass} = 1\mu F, R_L = 8\Omega$		70.0		dB
		Input GND 217Hz, $V_{Ripple} = 200mV_{p-p}$ $C_{Bypass} = 1\mu F, R_L = 8\Omega$		62.0		dB
		Input GND 1kHz $V_{Ripple} = 200mV_{p-p}$ $C_{Bypass} = 1\mu F, R_L = 8\Omega$		62.0		dB
$X_{Talk}$	Channel separation	$f = 1kHz, C_{Bypass} = 1\mu F$		-100		dB
$V_{NO}$	Output noise voltage	1kHz, A-weighted		7.0		$\mu V$

**Note1:** All parameters are production tested at  $25^\circ C$ , functional operation of the device and parameters specified over other temperature range, are guaranteed by design, characterization and process control.

**Note 2:** Guaranteed by design.

# IS31AP4066D

## TYPICAL PERFORMANCE CHARACTERISTICS

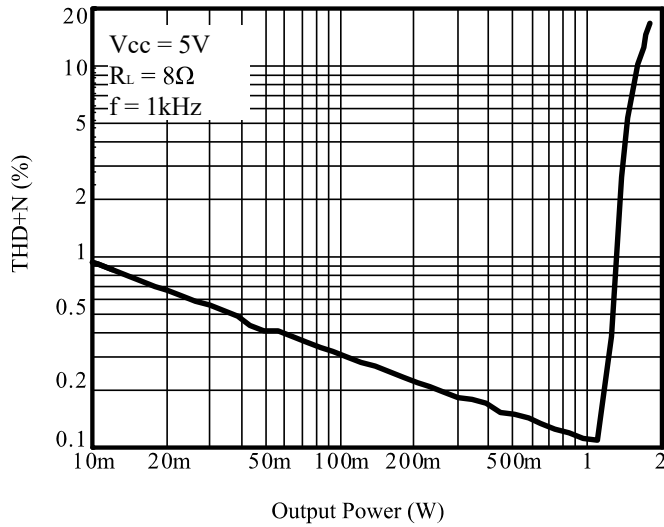

**Figure 2** THD+N vs. Output Power

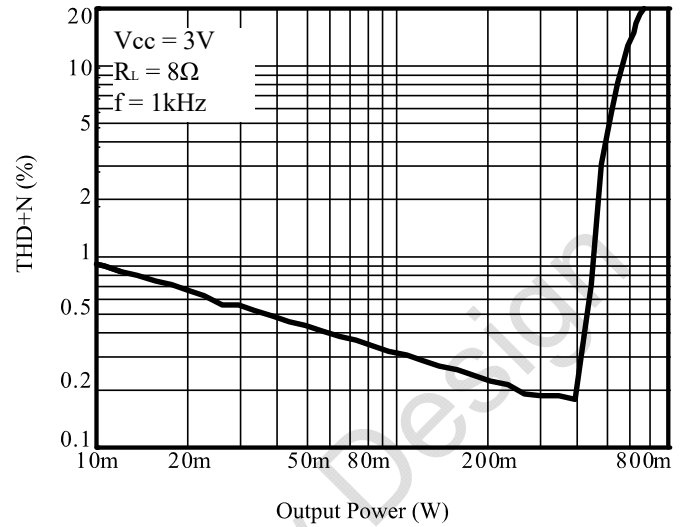

**Figure 3** THD+N vs. Output Power

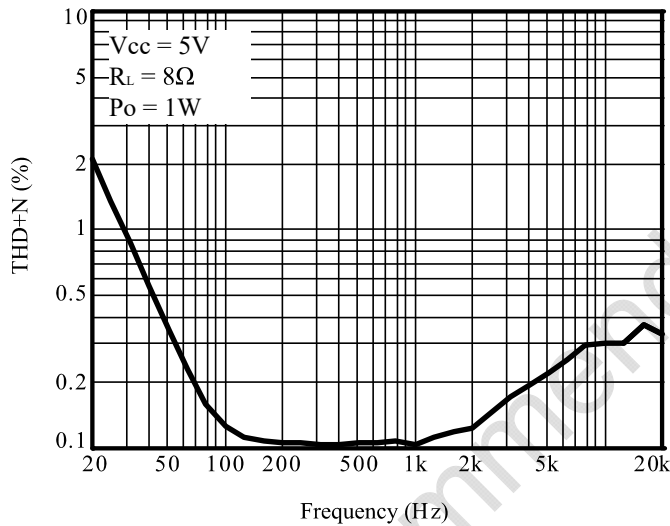

**Figure 4** THD+N vs. Frequency

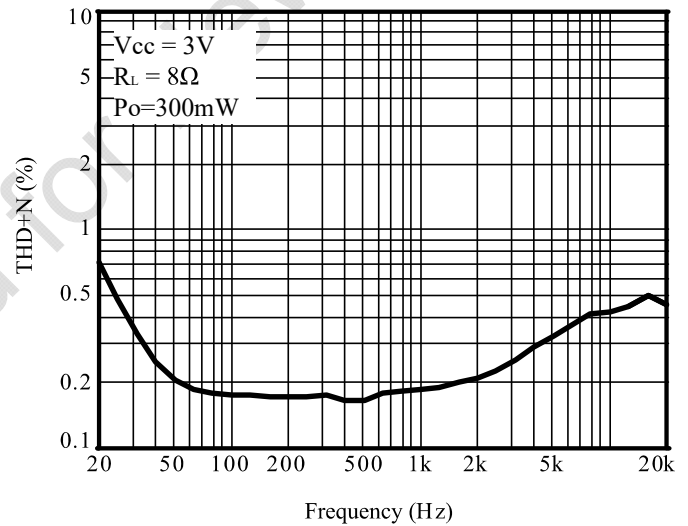

**Figure 5** THD+N vs. Frequency

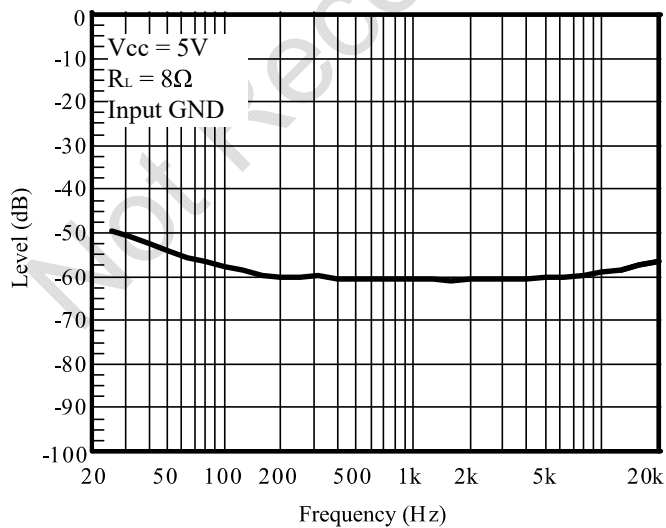

**Figure 6** PSRR vs. Frequency

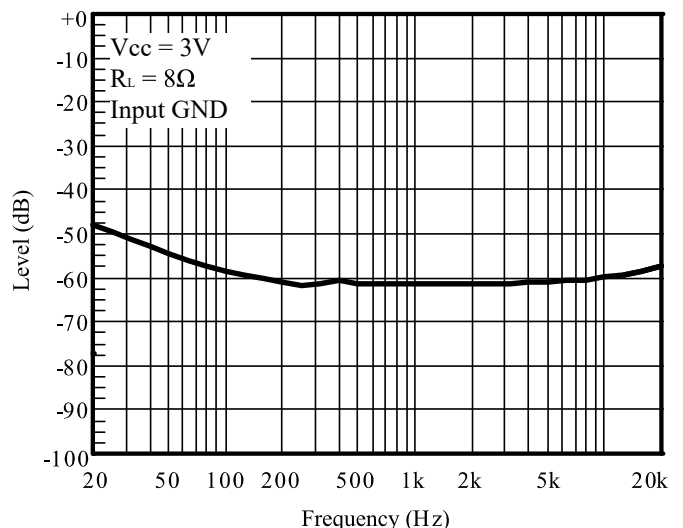

**Figure 7** PSRR vs. Frequency

# IS31AP4066D

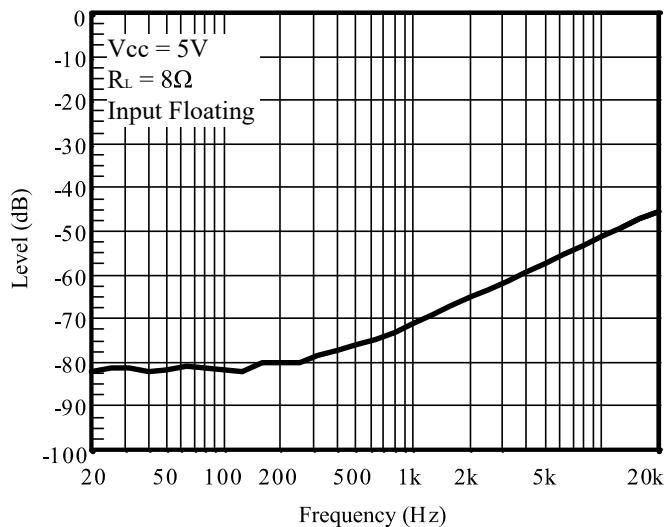

Figure 8 PSRR vs. Frequency

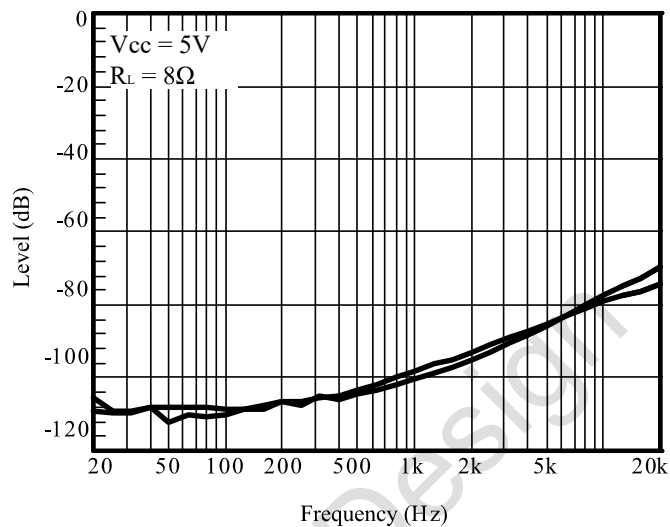

Figure 9 Crosstalk vs. Frequency

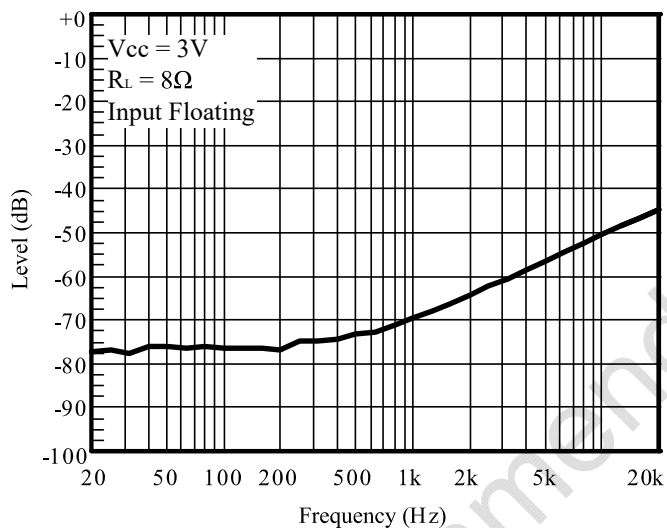

Figure 10 PSRR vs. Frequency

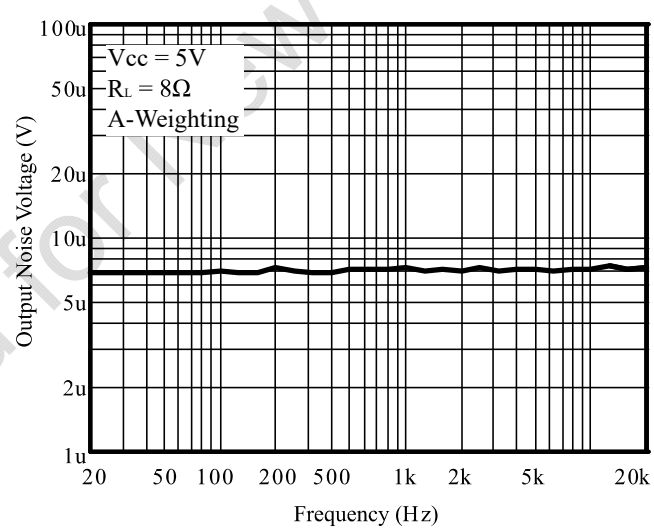

Figure 11 Noise Floor

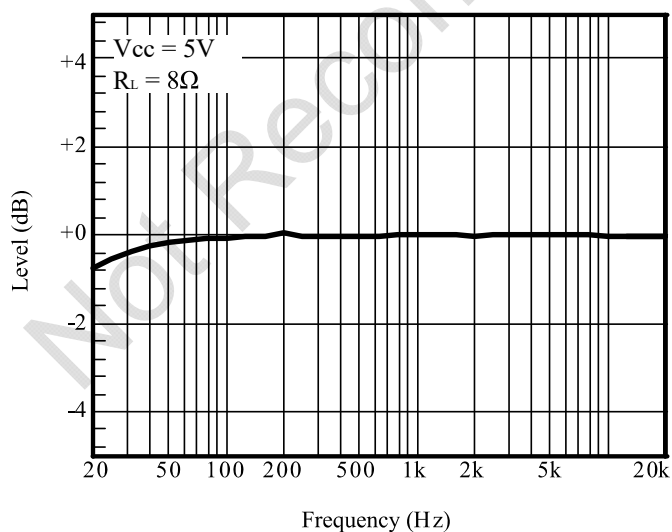

Figure 12 Frequency Response

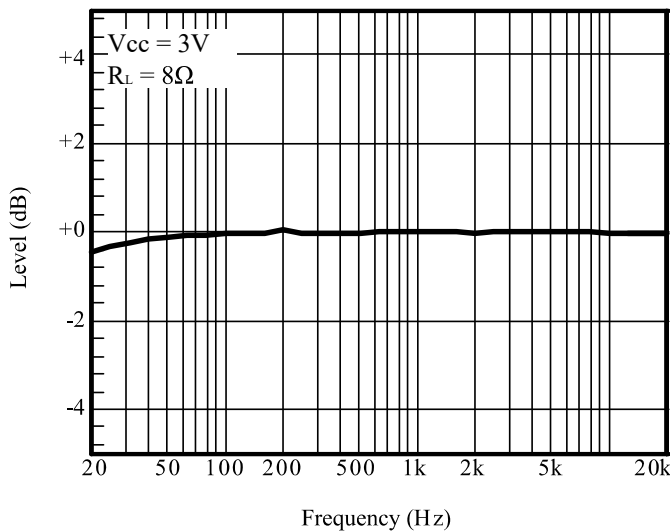
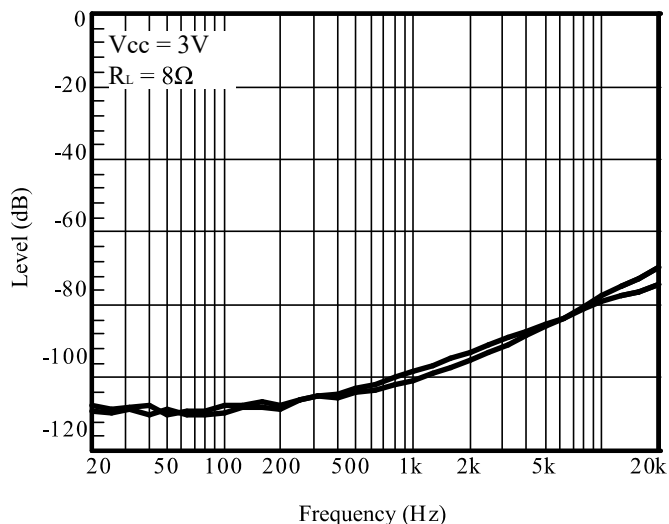
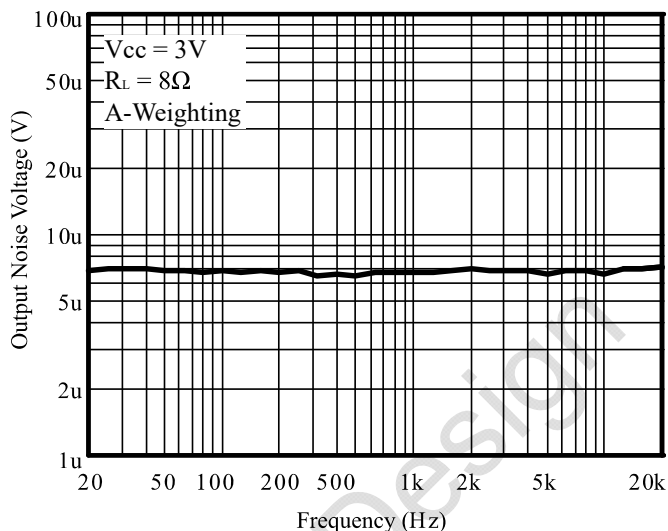

Figure 13 Frequency Response

# IS31AP4066D



**Figure 14** Crosstalk vs. Frequency



**Figure 15** Noise Floor

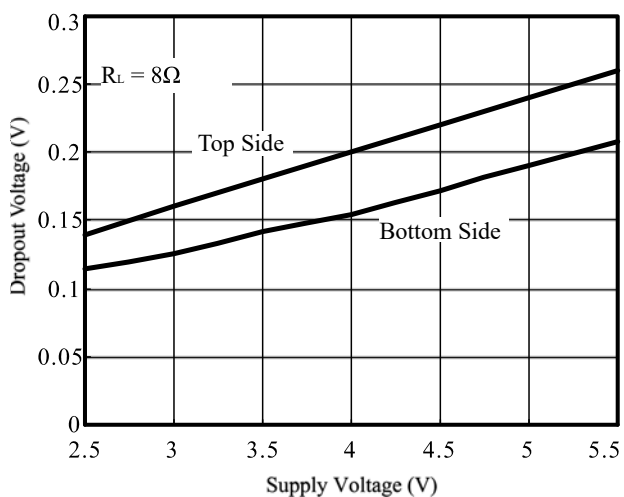

**Figure 16** Dropout Voltage vs. Supply Voltage

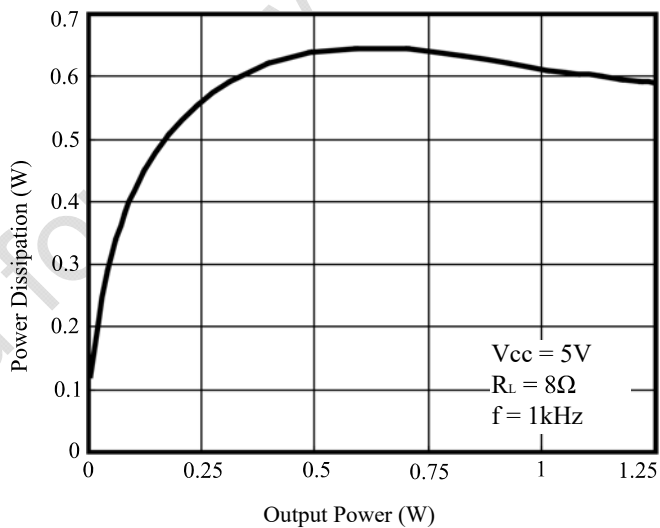

**Figure 17** Power Dissipation vs. Output Power

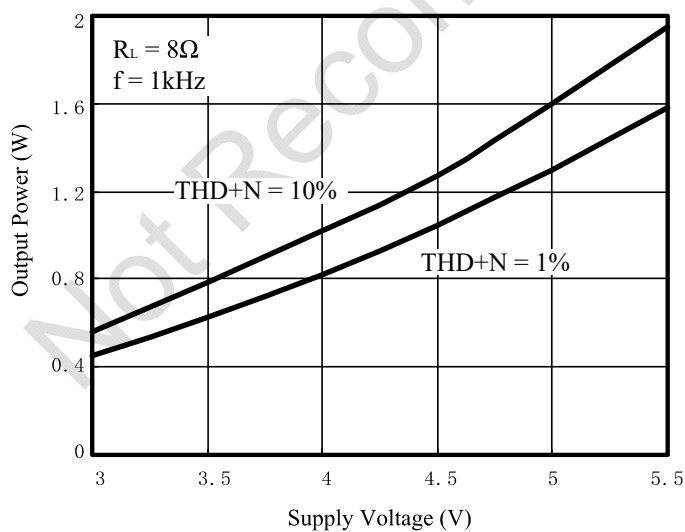
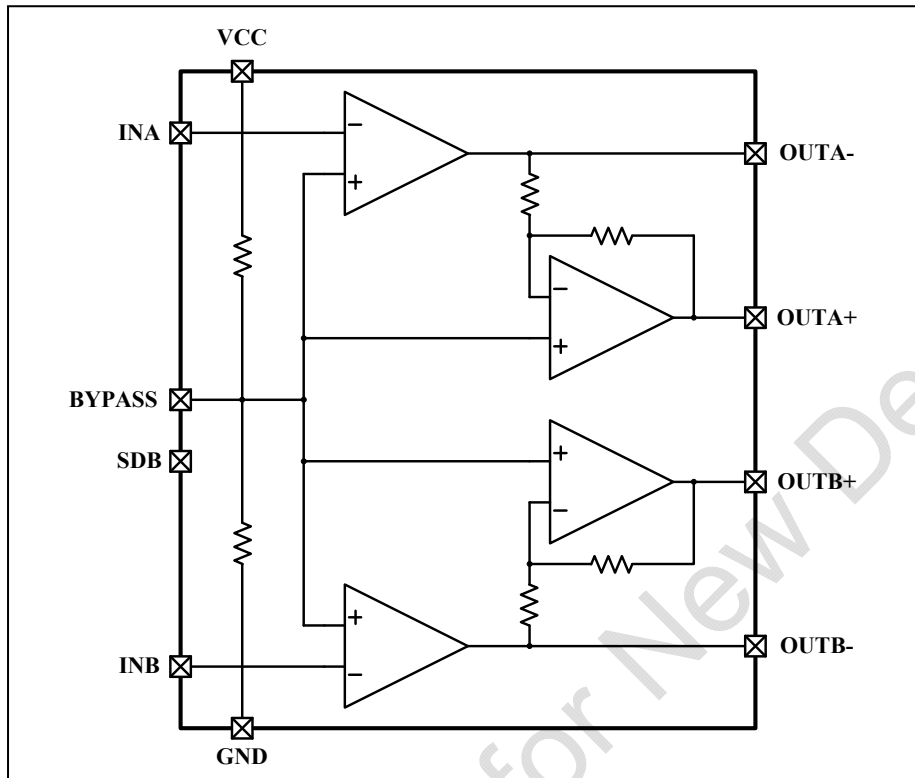

**Figure 18** Output Power vs. Supply Voltage



# IS31AP4066D

## FUNCTIONAL BLOCK DIAGRAM



# IS31AP4066D

## APPLICATION INFORMATION

### EXPOSED-DAP PACKAGE PCB MOUNTING CONSIDERATIONS

The IS31AP4066D's QFN (die attach paddle) package provides a low thermal resistance between the die and the PCB to which the part is mounted and soldered. This allows rapid heat transfer from the die to the surrounding PCB copper traces, ground plane and, finally, surrounding air.

The QFN package must have its DAP soldered to a copper pad on the PCB. The DAP's PCB copper pad is connected to a large plane of continuous unbroken copper. This plane forms a thermal mass and heat sink and radiation area. Place the heat sink area on either outside plane in the case of a two-sided PCB, or on an inner layer of a board with more than two layers.

### BRIDGE CONFIGURATION EXPLANATION

As shown in Figure 1, the IS31AP4066D consists of two pairs of operational amplifiers, forming a two-channel (Channel A and Channel B) stereo amplifier. External feedback resistors  $R_F$  and input resistors  $R_{IN}$  set the closed-loop gain of Amp A (OUT-) and Amp B (OUT-) whereas two internal 20k $\Omega$  resistors set Amp A's (OUT+) and Amp B's (OUT+) gain at 1. The IS31AP4066D drives a load, such as speaker, connected between the two amplifier outputs, OUTA- and OUTA+.

Figure 1 shows that Amp A's (OUT-) output serves as Amp A's (OUT+) input. This results in both amplifiers producing signals identical in magnitude, but 180° out of phase. Taking advantage of this phase difference, a load is placed between OUTA- and OUTA+ and driven differentially (commonly referred to as "bridge mode"). This results in a differential gain of

$$A_V = 2 \times (R_F / R_{IN}) \quad (1)$$

Bridge mode amplifiers are different from single-ended amplifiers that drive loads connected between a single amplifier's output and ground. For a given supply voltage, bridge mode has a distinct advantage over the single-ended configuration: its differential output doubles the voltage swing across the load. This produces four times the output power when compared to a single-ended amplifier under the same conditions. This increase in attainable output power assumes that the amplifier is not current limited.

Another advantage of the differential bridge output is no net DC voltage across the load. This is accomplished by biasing Channel A's and Channel B's outputs at half-supply. This eliminates the coupling capacitor that single supply, single ended amplifiers require. Eliminating an output coupling capacitor in a single-ended configuration forces a single-supply amplifier's half-supply bias voltage across the load. This increases internal IC power dissipation and may permanently damage loads such as speakers.

### POWER SUPPLY BYPASSING

As with any power amplifier, proper supply bypassing is critical for low noise performance and high power supply rejection. Applications that employ a 5V regulator typically use a 10 $\mu$ F in parallel with a 0.1 $\mu$ F filter capacitor to stabilize the regulator's output, reduce noise on the supply line, and improve the supply's transient response. However, their presence does not eliminate the need for a local 1.0 $\mu$ F tantalum bypass capacitance connected between the IS31AP4066D's supply pins and ground. Keep the length of leads and traces that connect capacitors between the IS31AP4066D's power supply pin and ground as short as possible.

### MICRO-POWER SHUTDOWN

The voltage applied to the SDB pin controls the IS31AP4066D's shutdown function. Activate micro-power shutdown by applying GND to the SDB pin. When active, the IS31AP4066D's micro-power shutdown feature turns off the amplifier's bias circuitry, reducing the supply current. The low 0.3 $\mu$ A typical shutdown current is achieved by applying a voltage that is as near as GND as possible to the SDB pin.

There are a few ways to control the micro-power shutdown. These include using a single-pole, single-throw switch, a microprocessor, or a microcontroller. When use a switch, connect an external 100k $\Omega$  resistor between the SDB pin and GND. Select normal amplifier operation by closing the switch. Opening the switch sets the SDB pin to ground through the 100k $\Omega$  resistor, which activates the micropower shutdown. The switch and resistor guarantee that the SDB pin will not float. This prevents unwanted state changes. In a system with a microprocessor or a microcontroller, use a digital output to apply the control voltage to the SDB pin. Driving the SDB pin with active circuitry eliminates the pull up resistor.

### SELECTING PROPER EXTERNAL COMPONENTS

Optimizing the IS31AP4066D's performance requires properly selecting external components. Though the IS31AP4066D operates well when using external components with wide tolerances, best performance is achieved by optimizing component values.

The IS31AP4066D is unity-gain stable, giving a designer maximum design flexibility. The gain should be set to no more than a given application requires. This allows the amplifier to achieve minimum THD+N and maximum signal-to-noise ratio. These parameters are compromised as the closed-loop gain increases. However, low gain demands input signals with greater voltage swings to achieve maximum output power. Fortunately, many signal sources such as audio CODECs have outputs of 1VRMS (2.83V<sub>P-P</sub>). Please

# IS31AP4066D

refer to the Audio Power Amplifier Design section for more information on selecting the proper gain.

## INPUT CAPACITOR VALUE SELECTION

Amplifying the lowest audio frequencies requires high value input coupling capacitors  $C_{IN}$  in Figure 1. A high value capacitor can be expensive and may compromise space efficiency in portable designs. In many cases, however, the speakers used in portable systems, whether internal or external, have little ability to reproduce signals below 150Hz. Applications using speakers with this limited frequency response reap little improvement by using large input capacitor.

Besides effecting system cost and size,  $C_{IN}$  have an effect on the IS31AP4066D's click and pop performance. When the supply voltage is first applied, a transient (pop) is created as the charge on the input capacitor changes from zero to a quiescent state. The magnitude of the pop is directly proportional to the input capacitor's size. Higher value capacitors need more time to reach a quiescent DC voltage (usually  $V_{CC}/2$ ) when charged with a fixed current. The amplifier's output charges the input capacitor through the feedback resistors,  $R_F$ . Thus, pops can be minimized by selecting an input capacitor value that is no higher than necessary to meet the desired  $-3dB$  frequency.

As shown in Figure 1, the input resistors  $R_{IN}$  and the input capacitors  $C_{IN}$  produce a  $-3dB$  high pass filter cutoff frequency that is found using Equation (2).

$$f_{-3dB} = 1/2\pi R_{IN}C_{IN} \quad (2)$$

As an example when using a speaker with a low frequency limit of 150Hz,  $C_{INA}$ , using Equation (2) is  $0.053\mu F$ . The  $0.33\mu F$   $C_{INA}$  allows the IS31AP4066D to drive high efficiency, full range speaker whose response extends below 30Hz.

## BYPASS CAPACITOR VALUE SELECTION

Besides minimizing the input capacitor size, careful consideration should be paid to value of  $C_{BYPASS}$ , the capacitor connected to the BYPASS pin. Since  $C_{BYPASS}$  determines how fast the IS31AP4066D settles to quiescent operation, its value is critical when minimizing turn-on pops. The slower the IS31AP4066D's outputs ramp to their quiescent DC voltage (nominally  $1/2V_{CC}$ ), the smaller the turn-on pop.

Choosing  $C_{BYPASS}$  equal to  $1.0\mu F$  along with a small value of  $C_{IN}$  (in the range of  $0.1\mu F$  to  $0.39\mu F$ ), produces a click-less and pop-less shutdown function. As discussed above, choosing  $C_{IN}$  no larger than necessary for the desired band with helps minimize click-and-pop. Connecting a  $1\mu F$  capacitor,  $C_{BYPASS}$ , between the BYPASS pin and ground improves the internal bias voltage's stability and improves the amplifier's PSRR.

## OPTIMIZING CLICK-AND-POP REDUCTION PERFORMANCE

The IS31AP4066D contains circuitry that minimizes turn-on and shutdown transients or "click-and-pop". For this discussion, turn-on refers to either applying the power supply voltage or when the shutdown mode is deactivated. When the part is turned on, an internal current source changes the voltage of the BYPASS pin in a controlled, linear manner. Ideally, the input and outputs track the voltage applied to the BYPASS pin. The gain of the internal amplifiers remains unity until the voltage on the bypass pin reaches  $1/2V_{CC}$ . As soon as the voltage on the bypass pin is stable, the device becomes fully operational. Although the BYPASS pin current cannot be modified, changing the size of  $C_{BYPASS}$  alters the device's turn-on time and the magnitude of "click-and-pop". Increasing the value of  $C_{BYPASS}$  reduces the magnitude of turn-on pops. However, this presents a tradeoff: as the size of  $C_{BYPASS}$  increases, the turn-on time increases. There is a linear relationship between the size of  $C_{BYPASS}$  and the turn-on time. Here are some typical turn-on times for various values of  $C_{BYPASS}$  (all tested at  $V_{CC} = 5V$ ):

$C_{BYPASS}$	$t_{ON}$
$0.01\mu F$	13ms
$0.1\mu F$	26ms
$0.22\mu F$	44ms
$0.47\mu F$	68ms
$1.0\mu F$	120 ms

In order eliminate "click-and-pop"; all capacitors must be discharged before turn-on. Rapidly switching  $V_{CC}$  on and off may not allow the capacitors to fully discharge, which may cause "click-and-pop".

# IS31AP4066D

## CLASSIFICATION REFLOW PROFILES

Profile Feature	Pb-Free Assembly
<b>Preheat &amp; Soak</b>	
Temperature min (T <sub>smin</sub> )	150°C
Temperature max (T <sub>smax</sub> )	200°C
Time (T <sub>smin</sub> to T <sub>smax</sub> ) (t <sub>s</sub> )	60-120 seconds
Average ramp-up rate (T <sub>smax</sub> to T <sub>p</sub> )	3°C/second max.
Liquidous temperature (T <sub>L</sub> )	217°C
Time at liquidous (t <sub>L</sub> )	60-150 seconds
Peak package body temperature (T <sub>p</sub> )*	Max 260°C
Time (t <sub>p</sub> )** within 5°C of the specified classification temperature (T <sub>c</sub> )	Max 30 seconds
Average ramp-down rate (T <sub>p</sub> to T <sub>smax</sub> )	6°C/second max.
Time 25°C to peak temperature	8 minutes max.

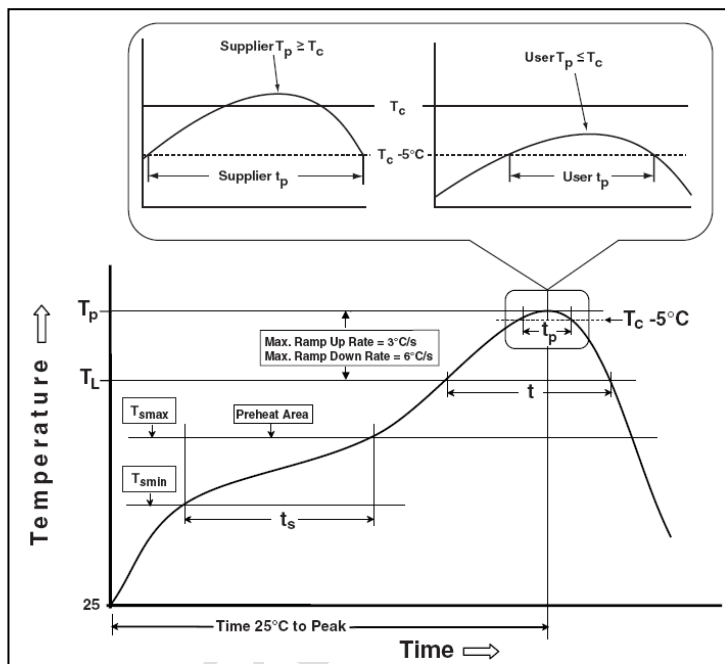
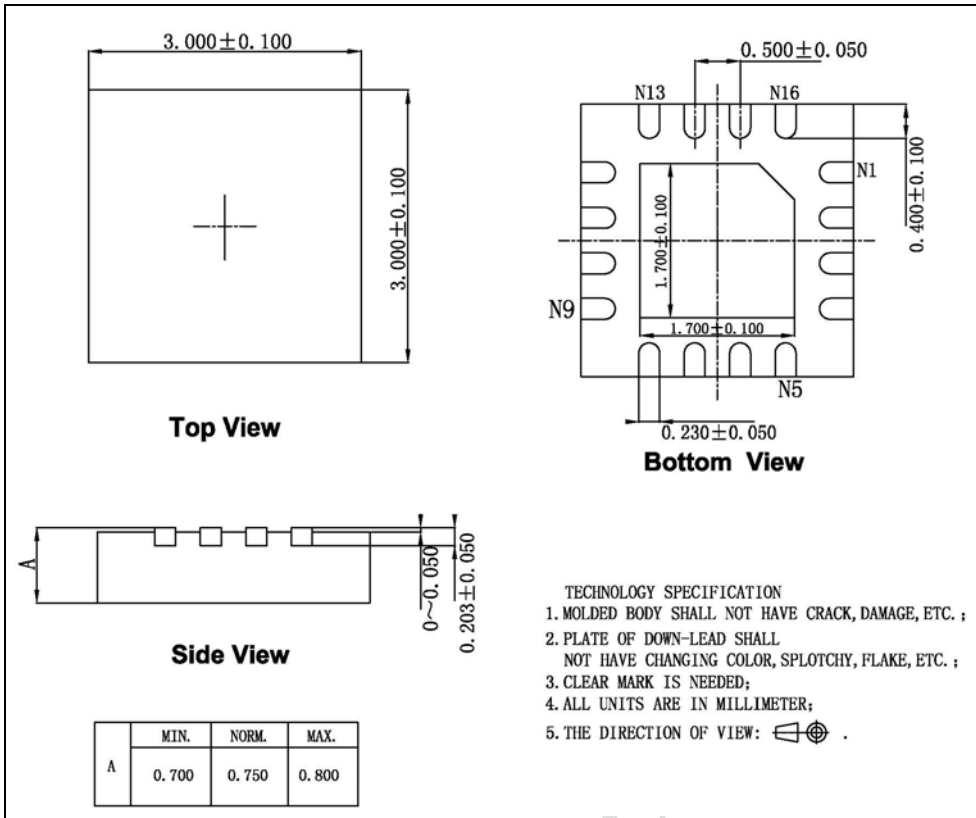

Figure 19 Classification Profile

# IS31AP4066D

## PACKAGE INFORMATION

### QFN-16



**Note:** All dimensions in millimeters unless otherwise stated.

# IS31AP4066D



A Division of 

## REVISION HISTORY

Revision	Detail Information	Date
A	Initial release	2011.12.13
B	1. Add ESD(HBM/CDM) 2. Add function block	2014.01.06
C	Add NRND watermark	2021.09.07

Not Recommend for New Design