

Amphenol FCI
 © 2016 AFCl

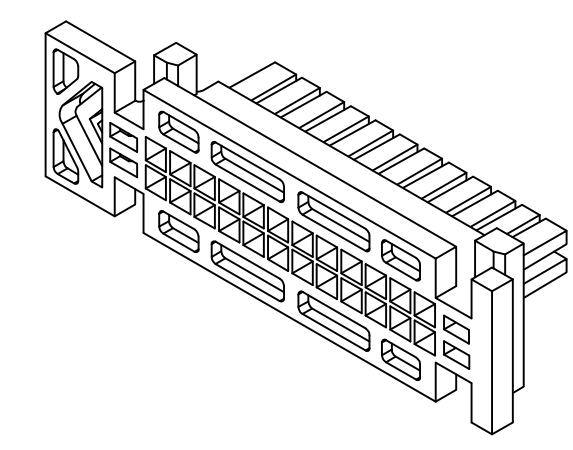

- NOTE:
- MATERIAL:
HOUSING: NYLON 66, HALOGEN FREE
UL94V-0, COLOR: BLACK
 - REFER GS-20-0399 APPLICATION SPECIFICATION FOR MATING CONNECTOR.
 - PRODUCT SPECIFICATION: GS-12-1177.
 - PACKAGE SPECIFICATION: GS-14-2359 (BULK PACKED)
 - APPLICATION SPECIFICATION: GS-20-0399.
 - LEAD FREE PRODUCTS MEET EUROPEAN UNION DIRECTIVES AND OTHER COUNTRY REGULATIONS AS DESCRIBED IN GS-47-0004
 - PART NUMBER SCHEME:
10159684-XX X LF

POS. CODE: ——— LEAD FREE
 04: 4 POS. ——— GLOW WIRE COMPATIBLE:
 06: 6 POS. ——— G: COMPATIBLE
 24: 24 POS.

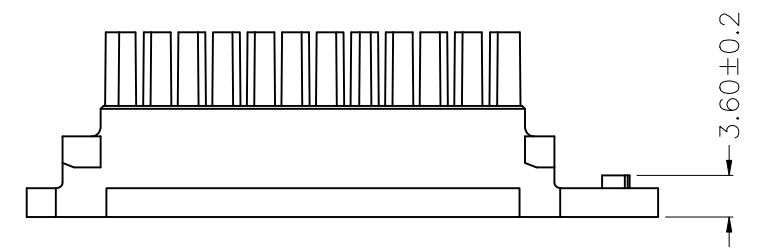
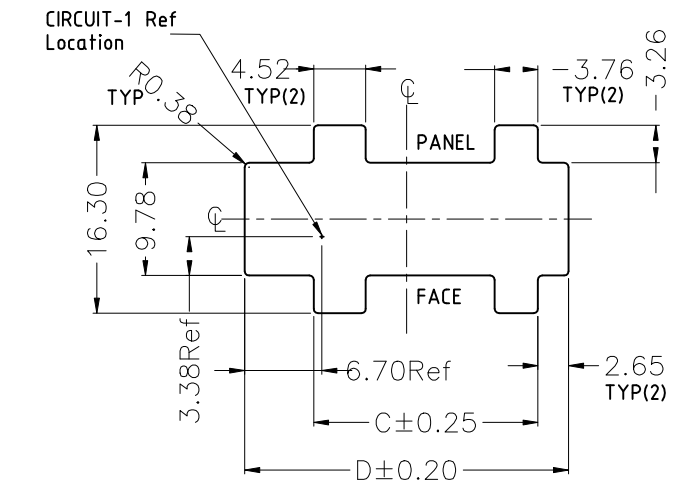
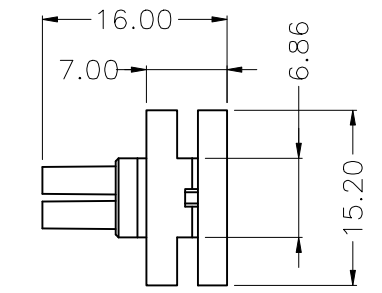
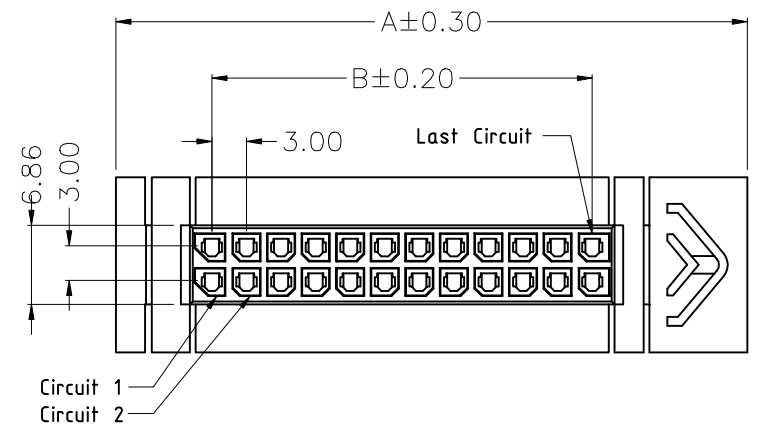

RECOMMENDED PANEL CUT-OUT
 THICK: 1.27mmMin/1.57mmMax
 General Tolerance ±0.05

PART NUMBER	POS	Dimensions(mm)			
		A	B	C	D
10159684-04XLF	4	24.6	3.00	13.46	22.10
10159684-06XLF	6	27.7	6.00	16.46	25.10
10159684-08XLF	8	30.7	9.00	19.46	28.10
10159684-10XLF	10	33.8	12.00	22.46	31.10
10159684-12XLF	12	36.8	15.00	25.46	34.10
10159684-14XLF	14	39.8	18.00	28.46	37.10
10159684-16XLF	16	42.8	21.00	31.46	40.10
10159684-18XLF	18	45.8	24.00	34.46	43.10
10159684-20XLF	20	48.8	27.00	37.46	46.10
10159684-22XLF	22	51.8	30.00	40.46	49.10
10159684-24XLF	24	54.8	33.00	43.46	52.10

mat'l. code		surface ISO 1302		tolerance ISO 406 ISO 1101		projection		product family	
ltr		ecn no		dr		date		MINITEK PWR 3.0	
A		JJ		2020-08-14		tolerances unless otherwise specified		title	
B		ELX-I-43588		AKHIL		2022-01-21		DUAL ROW BMI REC HOUSING	
						angles linear		MINITEK POWER 3.0	
						0°±x'		scale N.T.S	
						dr		JILTO JOHNSON 2020-08-14	
						engr		AKHIL RAJAN 2022-01-21	
						chr		MITHUN PAUL 2022-01-21	
						appd		SPK 2022-01-21	
sheet index		revision sheet		B 1		B 2		dwg no 10159684	
								sheet 1 of 2 size A3	
								type Product Customer Drawing	



Amphenol
FCi

© 2016 AFCI

1 | 2 | 3 | 4 | 5 | 6

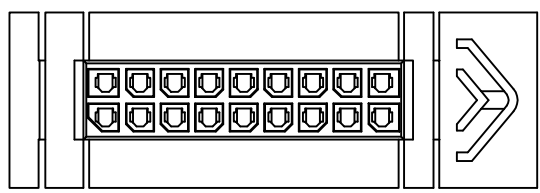

18POS

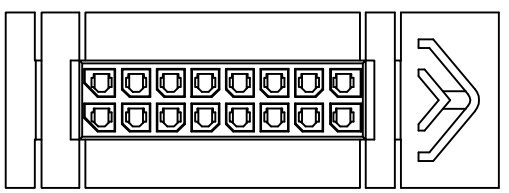

16POS

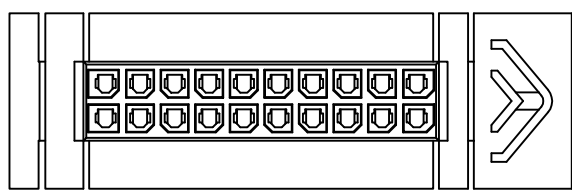

20POS

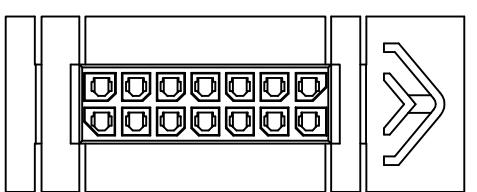

14POS

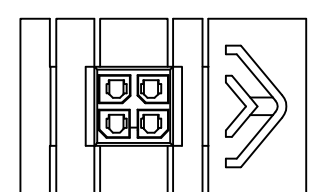

4POS

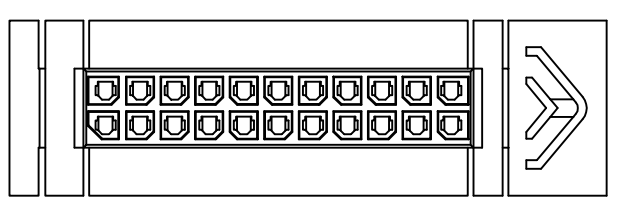

22POS

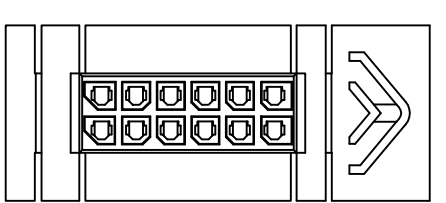

12POS

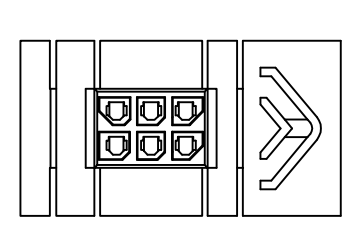

6POS

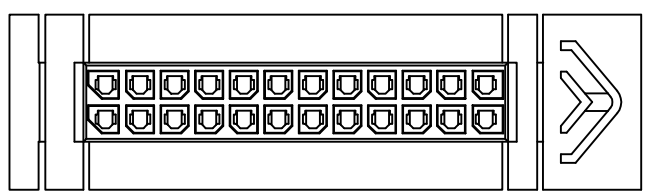

24POS

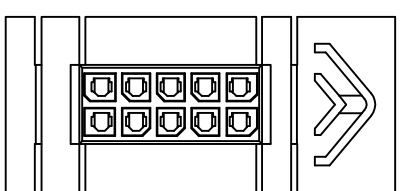

10POS

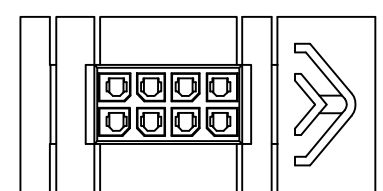

8POS

A

B

C

D

A

B

C

D

mat'l. code		surface		tolerance		projection		product family	
		ISO 1302 ✓		ISO 406 ISO 1101				MINITEK PWR 3.0	
ltr		ecn no		dr		date		title	
								DUAL ROW BMI REC HOUSING	
								MINITEK POWER 3.0	
								dwg no	
								sheet 2 of 2	
								size	
								A3	
								type	
								Product Customer Drawing	
sheet index		revision		B		B			
		sheet		1		2			