

CDBD620-G Thru. CDBD6100-G

Reverse Voltage: 20 to 100 Volts

Forward Current: 6.0 Amp

RoHS Device

Features

- Batch process design, excellent power dissipation offers better reverse leakage current and thermal resistance.
- Low profile surface mounted application in order to optimize board space.
- Low power loss, high efficiency.
- High current capability, low forward voltage drop.
- High surge capability.
- Guardring for overvoltage protection.
- Ultra high-speed switching.
- Silicon epitaxial planar chip, metal silicon junction.
- Lead-free parts meet environmental standards of MIL-STD-19500 /228

Mechanical data

- Case: TO-252/DPAK, molded plastic.
- Terminals: solderable per MIL-STD-750, method 2026.
- Polarity: Indicated by cathode band.
- Weunting Position: Any
- Weight:0.34 gram(approx.).

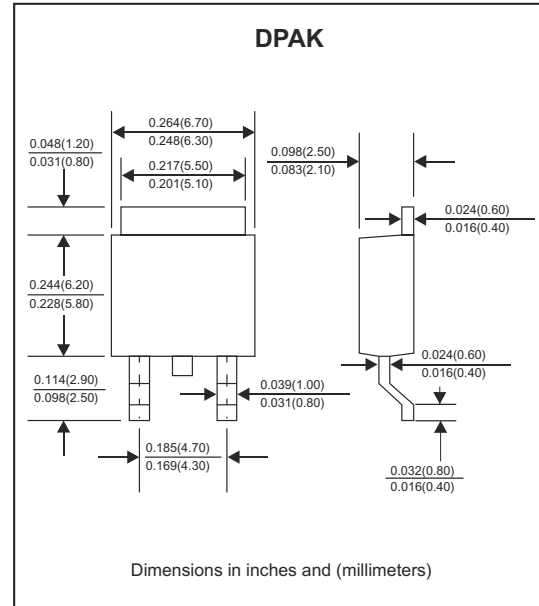
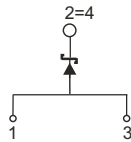

Maximum Ratings (At Ta=25°C, unless otherwise noted)

Parameter	Symbol	CDBD 620-G	CDBD 640-G	CDBD 650-G	CDBD 660-G	CDBD 680-G	CDBD 6100-G	Unit	
Repetitive peak reverse voltage	V_{RRM}	20	40	50	60	80	100	V	
Continuous reverse voltage	V_R	20	40	50	60	80	100	V	
RMS voltage	V_{RMS}	14	28	35	42	56	70	V	
Forward rectified current (See fig. 1)	I_o	6.0						A	
Maximum forward voltage $I_F=6.0A$	V_F	0.55		0.75		0.85		V	
Forward surge current, 8.3ms single half sine-wave superimposed on rated load (JEDEC method)	I_{FSM}	75						A	
Reverse current	$V_R=V_{RRM}$ $T_A=25^\circ C$	I_R						0.5	mA
	$V_R=V_{RRM}$ $T_A=100^\circ C$	I_R						20	mA
Thermal resistance	Junction to ambient	$R_{\theta JA}$						80	$^\circ C/W$
	Junction to case	$R_{\theta JC}$						3.0	$^\circ C/W$
Operating temperature	T_J	-55 to +125			-55 to +150				$^\circ C$
Storage temperature	T_{STG}	-65 to +175						$^\circ C$	

RATING AND CHARACTERISTIC CURVES (CDBD620-G Thru. CDBD6100-G)

FIG.1-TYPICAL FORWARD CURRENT DERATING CURVE

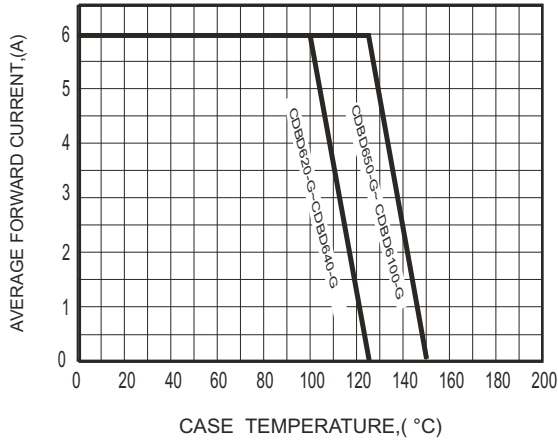

FIG.2-TYPICAL FORWARD CHARACTERISTICS

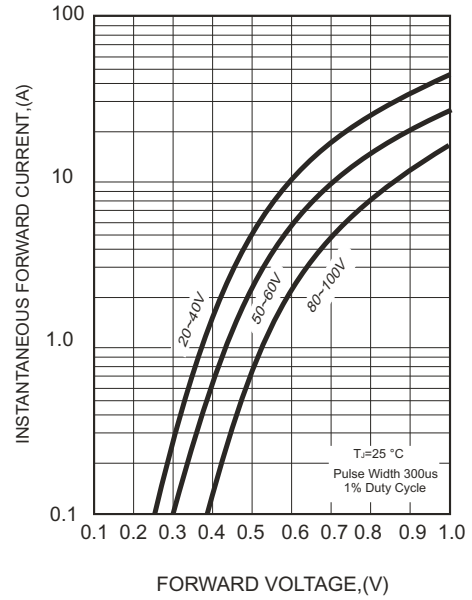

FIG.3-MAXIMUM NON-REPETITIVE FORWARD SURGE CURRENT

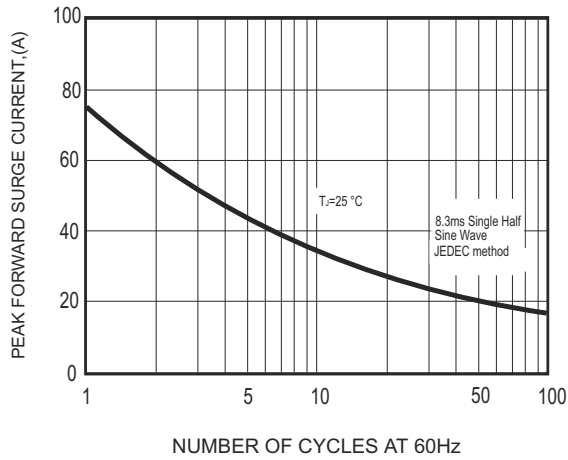
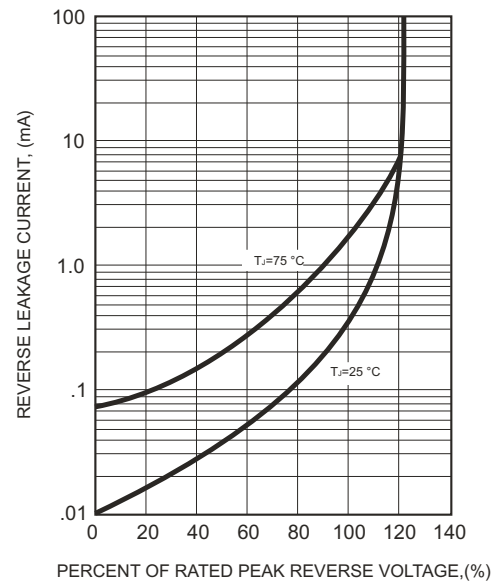
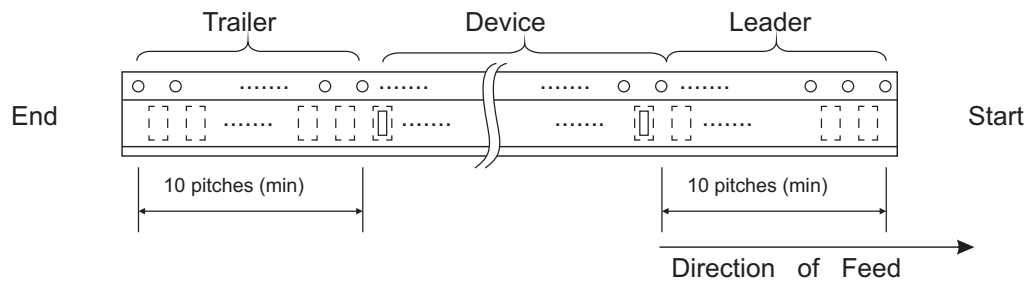
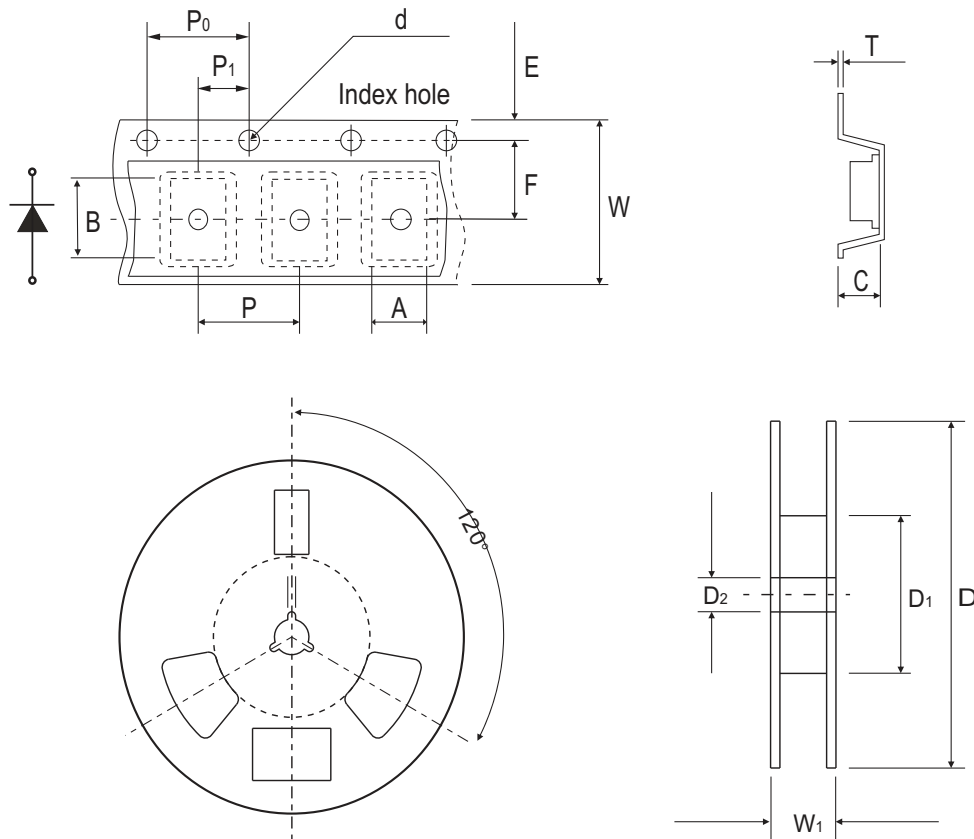

FIG.4 - TYPICAL REVERSE CHARACTERISTICS



Reel Taping Specification



TO-252/DPAK	SYMBOL	A	B	C	d	D	D1	D2
	(mm)	6.90 ± 0.10	10.50 ± 0.10	2.70 ± 0.10	1.50 ± 0.10	330.00 ± 2.00	50.0 MIN.	13.0 ± 0.50
	(inch)	0.272 ± 0.004	0.413 ± 0.004	0.106 ± 0.004	0.059 ± 0.004	13.00 ± 0.079	1.969 MIN.	0.512 ± 0.020

TO-252/DPAK	SYMBOL	E	F	P	P0	P1	T	W	W1
	(mm)	1.75 ± 0.10	7.50 ± 0.10	8.00 ± 0.10	4.00 ± 0.10	2.00 ± 0.10	0.23 ± 0.10	16.00 ± 0.30	22.00 ± 1.0
	(inch)	0.069 ± 0.004	0.295 ± 0.004	0.315 ± 0.004	0.157 ± 0.004	0.079 ± 0.004	0.009 ± 0.004	0.630 ± 0.012	0.866 ± 0.039

Marking Code

Part Number	Marking Code
CDBD620-G	SK620Y
CDBD640-G	SK640Y
CDBD650-G	SK650Y
CDBD660-G	SK660Y
CDBD680-G	SK680Y
CDBD6100-G	SK6100Y

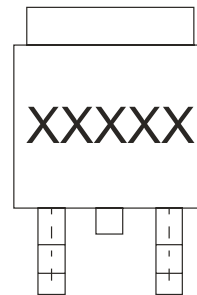

XXXXXX / XXXXXX = Product type marking code

Suggested PAD Layout

SIZE	TO-252 / DPAK	
	(mm)	(inch)
A	6.90	0.272
B	2.30	0.091
C	11.60	0.457
X1	7.00	0.276
X2	1.50	0.059
Y1	7.00	0.276
Y2	2.50	0.098

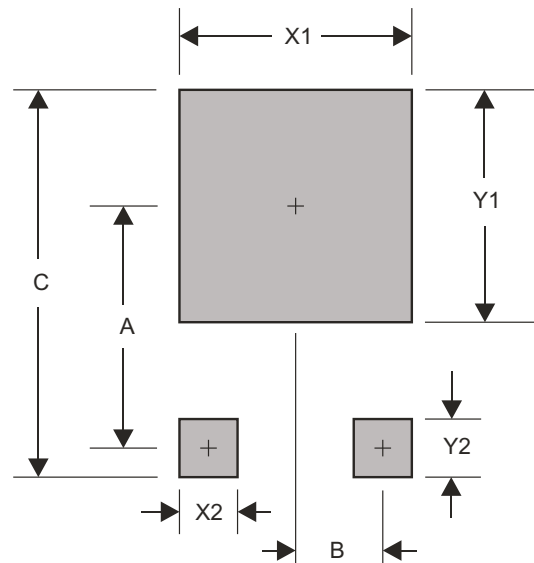

Standard Packaging

Case Type	REEL PACK	
	REEL (pcs)	Reel Size (inch)
TO-252/DPAK	3,000	13