

TOP VIEW

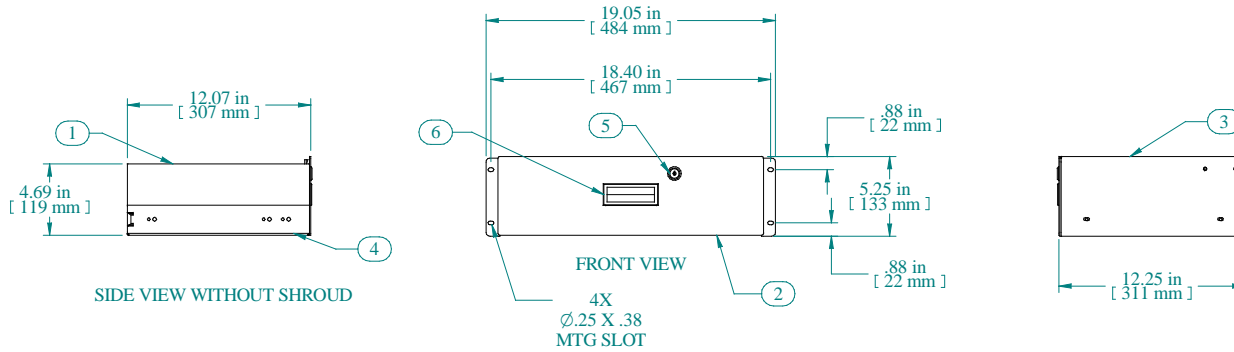
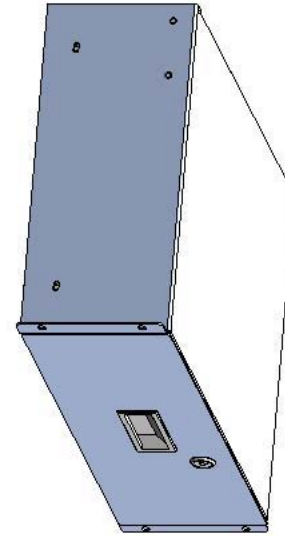

SIDE VIEW WITHOUT SHROUD

FRONT VIEW

Item Number	Title	Quantity
1	RDRW - DRAWER BODY	1
2	RDRW - DRAWER PLATE	1
3	RDRW - DRAWER SHROUD	1
4	SLIDE 12" FULL TRAVEL	2
5	LOC KEY-LOCK WITH NUT H-7.5 MM	1
6	PLASTIC HANDLE	1

PART NUMBERS

RDRW1900512BK1	PAINTED BLACK TEXTURED
RDRW1900512CG1	PAINTED GREY/BEIGE TEXTURED
RDRW1900512LG1	PAINTED RAL7035 TEXTURED

NOTES

Maximum Weight 60 lb No Rear Support
 Maximum Weight 120 lb Rear Supported
 Mounting Hardware Included

Data subject to change without notice. Isometric drawing not to scale.



**HAMMOND
MANUFACTURING™**
 www.hammondmfg.com
 PART NO. RDRW1900512