

#### Application

Motion sensor  
3D depth sensor  
Etc.

#### Outline view



#### Merit

Single mode  
Φ5.6 metal stem

#### Absolute Maximum Ratings (Tc=25°C)

Parameter	Symbol	Ratings	Unit
Optical output	Po	220	mW
Reverse voltage	LD	Vr	2
	PIN PD	Vr(PD)	20
Operating temp.	Top	-10 to 60	°C
Storage temp.	Tstg	-40 to 85	°C

#### Characteristics (Tc=25°C)

Parameter	Symbol	Conditions	MIN.	TYP.	MAX.	Unit
Threshold current	Ith	–	–	40	60	mA
Operating current	Iop	Po=200mW	–	250	350	mA
Operating voltage	Vop	Po=200mW	–	2.4	2.8	V
Output efficiency	η	50mW/ (I(200mW)-I(150mW))	0.7	0.95	1.5	W/A
Monitor current	Im	Po=200mW, Vr(PD)=5V	0.1	0.4	1	mA
Beam divergence	θ//	Po=200mW	7	9.5	12	deg.
	θ⊥		13	19	23	deg.
Beam tolerance	Δθ//	Po=200mW	-3	0	+3	deg.
	Δθ⊥		-4	0	+4	deg.
Emission point accuracy	ΔXYZ	–	-100	0	+100	μm
Lasing wavelength	λ	Po=200mW	842	852	862	nm

Caution: θ⊥ and θ// are defined as full width at half maximum.  
Operation temperature is regulated by case temperature; Tc

Electrical Characteristics

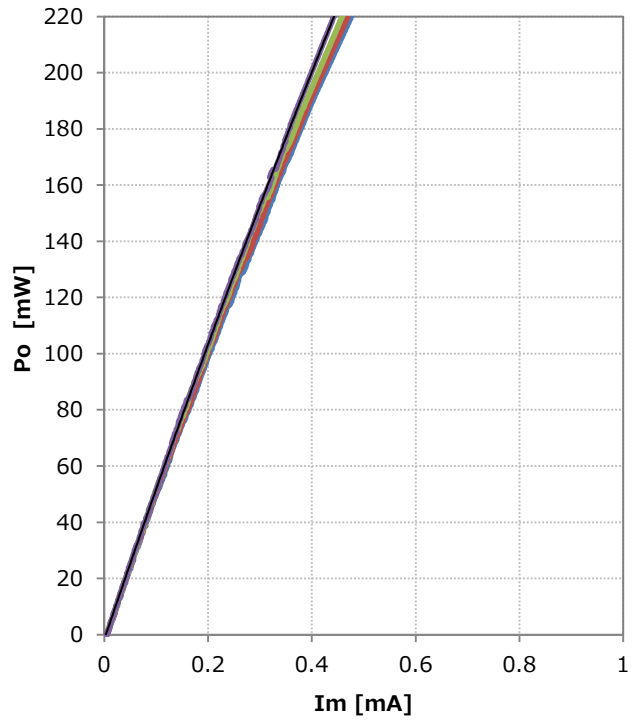
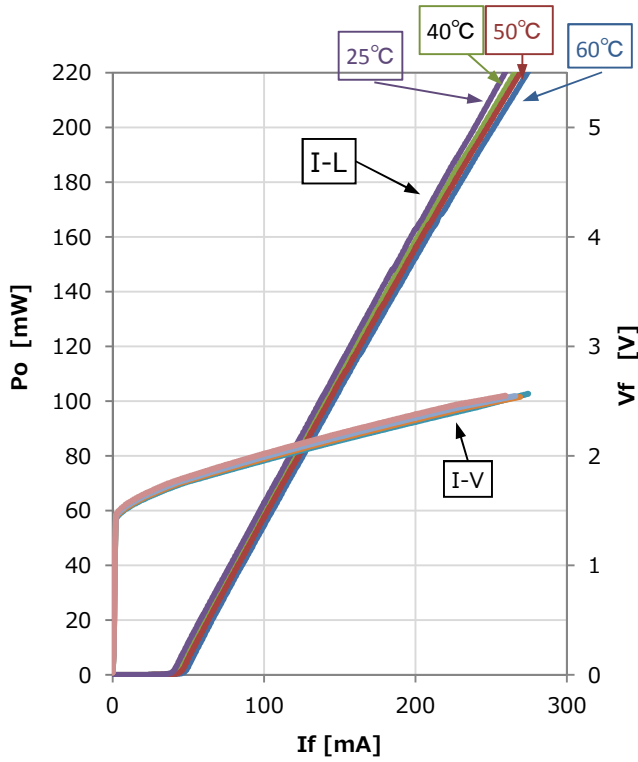

Optical Characteristics

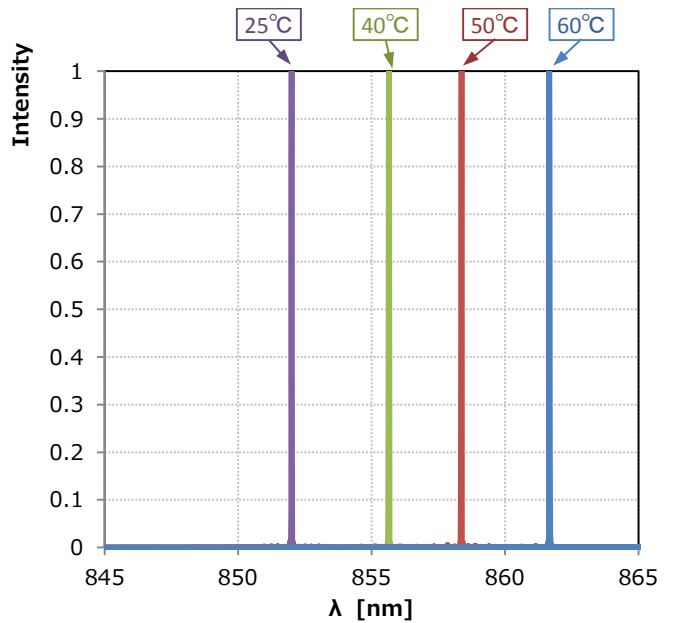
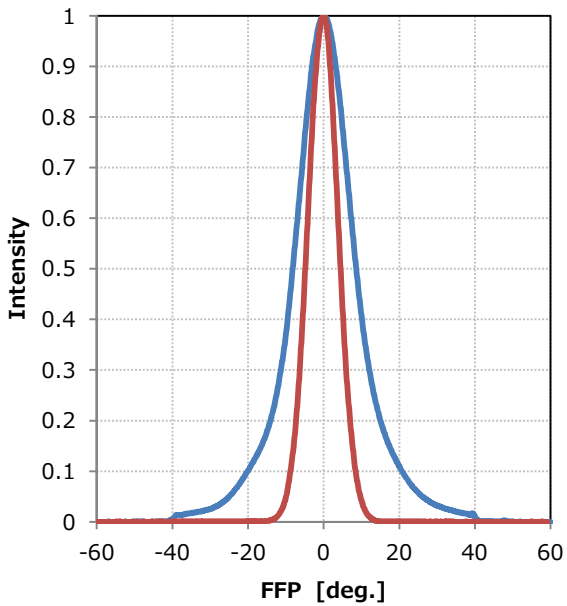

\* This data is made from the result of having measured the sample extracted at random. Therefore, it is not what showed the ability of the whole product.

Dimensions

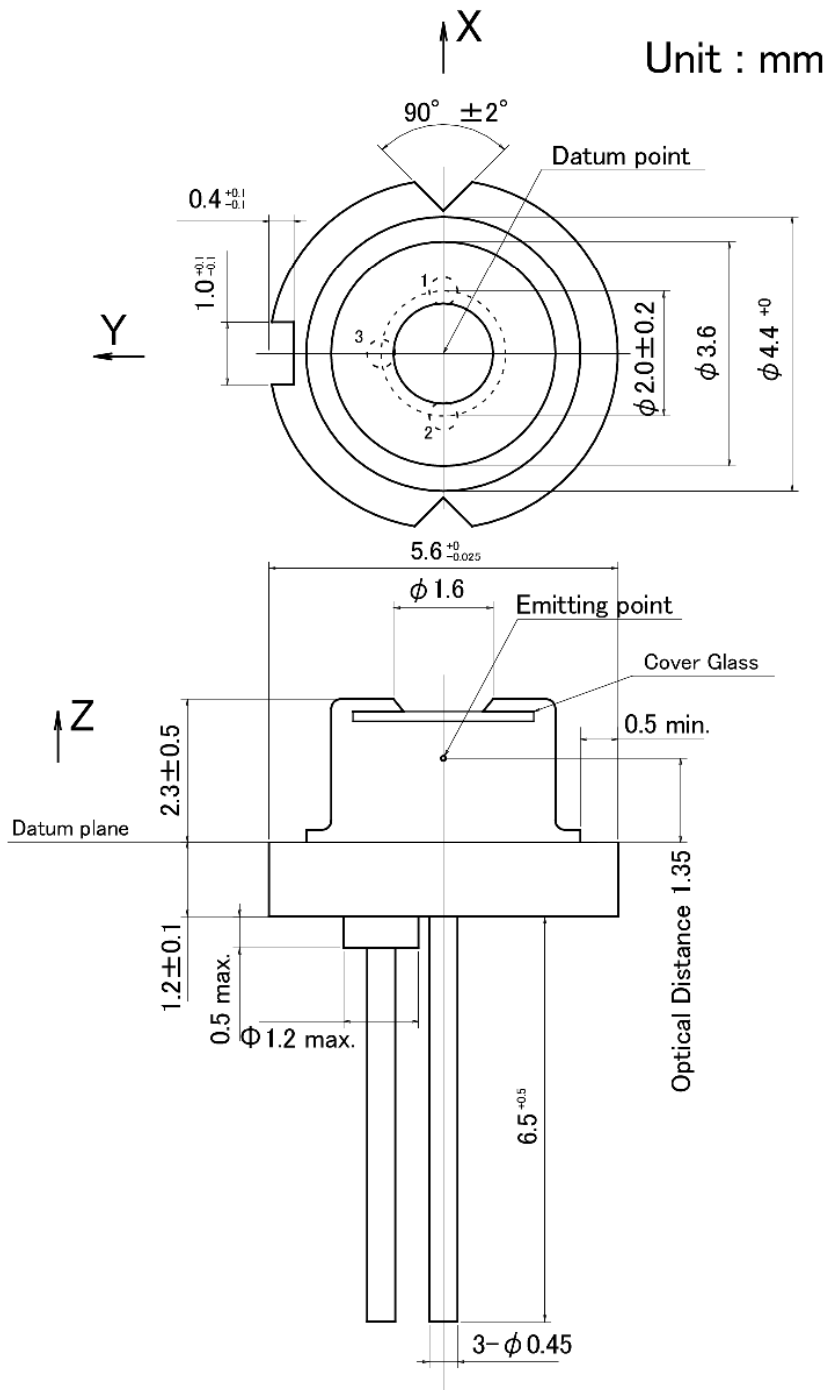

Equivalent Circuit Diagram

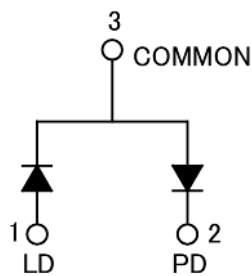

**Specifications (Precautions and Prohibitions)****• Precautions on using ROHM Products**

- 1) Our Products are designed and manufactured for application in ordinary electronic equipment (such as AV equipment, OA equipment, telecommunication equipment, home electronics appliances, amusement equipment, etc.). If you intend to use our Products in devices requiring extremely high reliability (such as medical equipment, transport equipment, traffic equipment, aircraft/spacecraft, nuclear power controllers, fuel controllers, car equipment including car accessories, safety devices, etc.) and whose malfunction or failure may cause loss of human life, bodily injury or serious damage to property ("Special Applications"), please consult with the ROHM sales representative in advance. Unless otherwise agreed in writing by ROHM in advance, ROHM shall not be in any way responsible or liable for any damages, expenses or losses incurred by you or third parties arising from the use of any ROHM's Products for Specific Applications.
- 2) ROHM designs and manufactures its Products subject to strict quality control system. However, semiconductor products can fail or malfunction at a certain rate. Please be sure to implement, at your own responsibilities, adequate safety measures including but not limited to fail-safe design against the physical injury, damage to any property, which a failure or malfunction of our Products may cause. The following are examples of safety measures.
  - [a] Installation of protection circuits or other protective devices to improve system safety
  - [b] Installation of redundant circuits to reduce the impact of single or multiple circuit failure
- 3) Our Products are designed and manufactured for use under standard conditions and not under any special or extraordinary environments or conditions, as exemplified below. Accordingly, ROHM shall not be in any way responsible or liable for any damages, expenses or losses arising from the use of any ROHM's Products under any special or extraordinary environments or conditions. If you intend to use our Products under any special or extraordinary environments or conditions (as exemplified below), your independent verification and confirmation of product performance, reliability, etc, prior to use, must be necessary:
  - [a] Use of our Products in any types of liquid, including water, oils, chemicals, and organic solvents
  - [b] Use of our Products outdoors or in places where the Products are exposed to direct sunlight or dust
  - [c] Use of our Products in places where the Products are exposed to sea winds or corrosive gases, including Cl<sub>2</sub>, H<sub>2</sub>S, NH<sub>3</sub>, SO<sub>2</sub>, and NO<sub>2</sub>
  - [d] Use of our Products in places where the Products are exposed to static electricity or electromagnetic waves
  - [e] Use of our Products in proximity to heat-producing components, plastic cords, or other flammable items
  - [f] Sealing or coating our Products with resin or other coating materials
  - [g] Use of our Products without cleaning residue of flux (even if you use no-clean type fluxes, cleaning residue of flux is recommended); or Washing our Products by using water or water-soluble cleaning agents for cleaning residue after soldering
  - [h] Use of the Products in places subject to dew condensation
- 4) The Products are not subject to radiation-proof design.
- 5) Please verify and confirm characteristics of the final or mounted products in using the Products.
- 6) In particular, if a transient load (a large amount of load applied in a short period of time, such as pulse) is applied, confirmation of performance characteristics after on-board mounting is strongly recommended. Avoid applying power exceeding normal rated power; exceeding the power rating under steady-state loading condition may negatively affect product performance and reliability.
- 7) De-rate Power Dissipation (Pd) depending on Ambient temperature (Ta). When used in sealed area, confirm the actual ambient temperature.
- 8) Confirm that operation temperature is within the specified range described in the product specification.
- 9) ROHM shall not be in any way responsible or liable for failure induced under deviant condition from what is defined in this document.

**● Precaution for Mounting / Circuit board design**

When a highly active halogenous (chlorine, bromine, etc.) flux is used, the residue of flux may negatively affect product performance and reliability.

Regarding Precaution for Mounting / Circuit board design, please specially refer to ROHM Mounting specification. (Refer to precaution of the individual product.)

**● Precautions Regarding Application Examples and External Circuits**

- 1) If change is made to the constant of an external circuit, please allow a sufficient margin considering variations of the characteristics of the Products and external components, including transient characteristics, as well as static characteristics.
- 2) You agree that application notes, reference designs, and associated data and information contained in this document are presented only as guidance for Products use. Therefore, in case you use such information, you are solely responsible for it and you must exercise you own independent verification and judgment in the use of such information contained in this document. ROHM shall not be in any way responsible or liable for damages, expenses or losses incurred by you or third parties arising from the use of such information.

**● Precaution for Electrostatic**

This Product is electrostatic sensitive product, which may be damaged due to electrostatic discharge. Please take proper caution in your manufacturing process and storage so that voltage exceeding Products maximum rating will not be applied to Products. Please take special care under dry condition (e.g. Grounding of human body / equipment / solder iron, isolation from charged objects, setting of Ionizer, friction prevention and temperature / humidity control).

**● Precautions for Storage / Transportation**

- 1) Product performance and soldered connections may deteriorate if the Products are stored in the places where:
  - [a] the Products are exposed to sea winds or corrosive gases, including Cl<sub>2</sub>, H<sub>2</sub>S, NH<sub>3</sub>, SO<sub>2</sub>, and NO<sub>2</sub>
  - [b] the temperature or humidity exceeds those recommended by ROHM  
(Ambient temperature: 5 to 40°C, relative humidity: 30 to 80%)
  - [c] the Products are exposed to direct sunshine or condensation
  - [d] the Products are exposed to high Electrostatic
- 2) Even under ROHM recommended storage condition, solder-ability of products out of recommended storage time period may be degraded.  
It is strongly recommended to confirm the characteristics and solder-ability before using Products of which storage time is exceeding the recommended storage time period (The recommended storage time period is one year after the shipment.)
- 3) Store / transport cartons in the correct direction, which is indicated on a carton as a symbol. Otherwise bent leads may occur due to excessive stress applied when dropping of a carton.

**● Precaution for product label**

QR code printed on ROHM product label is for ROHM's internal use only, and please do not use at customer site.

**● Precaution for disposition**

When disposing Products please dispose them properly using an authorized industry waste company.

**● Precaution for Foreign exchange and Foreign Trade act**

Note: Since concerned goods have not been determined to be fallen under listed items of export control prescribed by Foreign Exchange and Foreign Trade act or not, please consult with ROHM in case of export.

● Precautions Regarding Intellectual Property Rights

- 1) All information and data including but not limited to application example contained in this document is for reference only. ROHM does not warrant that foregoing information or data will not infringe any intellectual property rights or any other rights of any third party regarding such information or data.
- 2) ROHM shall not have any obligations where the claims, actions or demands arising from the combination of the Products with other articles such as components, circuits, systems or external equipment (including software)
- 3) No license, expressly or implied, is granted hereby under any intellectual property rights or other rights of ROHM or any third parties with respect to the Products or the information contained in this document. Provided, however, that ROHM will not assert its intellectual property rights or other rights against you or your customers to the extent necessary to manufacture or sell products containing the Products, subject to the terms and conditions herein.

● Other Matters

- 1) This document may not be reprinted or reproduced, in whole or in part, without prior written consent of ROHM.
- 2) The Products may not be disassembled, converted, modified, reproduced or otherwise changed without prior written consent of ROHM.
- 3) In no event shall you use in any way whatsoever the Products and the related technical information contained in the Products or this document for any military purposes, including but not limited to, the development of mass-destruction weapons.
- 4) The proper names of companies or products described in this document are trademarks of registered trademarks of ROHM, its affiliated companies or third parties.
- 5) The information contained herein is subject to change without notice.

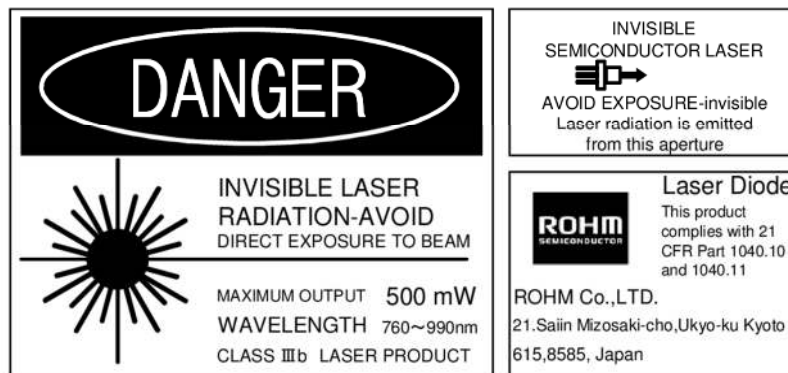

**Operation notes on use**

**This device is classified as a class IIIb laser product, emitting invisible laser radiation.**

**Direct exposure should be avoid and never look at the emitting surface.**

## 1) Absolute maximum ratings

If an excessively flows in a laser diode, a large optical output will occur and the emitting facet may sustain damage. This optical damage can occur even with momentary over-current. For this reason, absolute maximum ratings which must not be exceeded even momentarily have been established. Exercise particular caution with respect to the drive voltage supply and static electricity. We guarantee use within the absolute maximum ratings. These ratings are established for a case temperature of 25°C. As the temperature of laser diode increases, its maximum output will decrease and the operating range will shrink. Even when operated within the absolute maximum ratings, operation at high temperature will result in a shorter life than operation at low temperature. For this reason, the design should include sufficient margin for heat radiation and light output.

## 2) Heat radiation conditions

Like other semiconductors, prolonged operation of a laser diode will cause heat to build up at junctions and increased case temperature. For this reason, attach aluminum (or other) heat sinks (at least 30x30x3mm) to the stem of the laser.

## 3) Protection against damage due to electrostatic discharge and other current surges

Electrostatic discharge and other current surges can cause deterioration and damage in laser diode, resulting in reduced reliability. We advise talking the following protective measures.

- ① Ground the device and circuits. Install surge filters, surge reduction transformers, or other electrostatic discharge protectors in the power supply inputs.
- ② When working with laser diodes wear anti-static clothing, including footwear and caps. Grounded wrist straps should always be worn while working with laser diodes, and the trap should be grounded through a 1Mohm resistance.
- ③ Use anti-static containers for transport and storage.
- ④ Laser deterioration and damage can occur due to excessive current spikes when the power is turned on or off. Design circuits to avoid the generation of excessive current spikes.
- ⑤ Inductive surge near equipment that emits high-frequency EMI can damage or destroy lasers. Avoid using lasers near fluorescent lamps or other of EMI emissions.

## 4) Soldering

Use a grounded soldering iron to solder laser leads. Solder at a temperature of no more than 350°C for a maximum of 3 seconds, at a point at least 2mm from the root of the leads.

Please be careful to below points.

- ① The adhesiveness of the die-bonding paste dramatically declines in high temperature, thus the package temperature must be observed with extreme care at all times. Please avoid heating the whole package such as reflow soldering.
- ② It is recommended to heat only one lead frame at a time. (Please avoid heating multiple leads simultaneously.)
- ③ Heating the lead frame will cause the whole package temperature to rise thus it is recommended to release the package heat by heat sink during soldering.
- ④ It is recommended to solder the GND lead first to restrain the heat conduction from the lead frame.

## 5) In the use of the glue

There is the possibility that the volatilization component of the glue exerts the influence on the characteristic of laser diode. Please use it after it confirm sufficiently.

## 6) Handling packages

Packages must not be dropped or subjected to excessive pressure. In the forming processing, be careful not to add stress to the inner leads and cut wires. Never touch the glass parts of the laser. A damaged or dirtied glass parts will impair the performance of the laser.

## 7) Safety

It is extremely dangerous to look, either directly or through a lens, at the laser beam emitted from a laser diode. Use a TV camera or other similar device to adjust the optical axis.

**【Restrictions for using this Laser Diode】**

- 1) This product does not comply with the automotive electronic component reliability standard AEC-Q102. Therefore, it does not fulfill the quality requirements for automotive usage.
- 2) Do not use this product for the following applications below from (i) to (iii).
  - (i) any automotive applications and automotive environment
  - (ii) any product, machine, or equipment such as optical communication, fuel control, various safety equipment, and other equipment related to medical, transportation, traffic, aerospace, nuclear power control
  - (iii) any product, machine, or equipment that requires extremely high reliability or has the potential to impact human lives or inflict other serious damages.

If this product is used in these cases, ROHM will not assume any responsibilities including those stated below from 5) to 8).

- 3) Documents and data provided by ROHM at the time of the customer's part number acquisition and certification will be in ROHM's standard format.
- 4) ROHM assumes no responsibility and correspondence unless explicitly stated in 5) to 8) below. In this case, the items that ROHM will not correspond to includes ① to ⑥ but are not limited to them.
  - ① Joint design reviews with customers for occasions such as certification of this product
  - ② Quality improvement activities led by customers (zero defect research included but not limited to this).
  - ③ Sorting or exchanging of this product by lot.
  - ④ Measures to restrain the occurrence and spread of non-conformity and defects.
  - ⑤ Mounting and dismounting of this product on customers' products.
  - ⑥ Supporting of any appearance defects of this product.
- 5) If it is found that this product does not conform to this specification at the time of delivery, or if a failure occurs in the manufacturing process using this product, and ROHM judges that the defect is obviously attributable to this product, we will only exchange the defective / non-conformed parts to good ones.
- 6) In the event that ROHM determines that a failure occurring in any product, machinery or equipment (hereinafter referred to as "application") with this product installed, is obviously attributable to this product, ROHM will conduct a product analysis of the returned product. However, if the cause cannot be identified, additional investigations will not be conducted.
- 7) Only in the event that this product is used on applications, is within the scope of this specification, and three or more non-conforming/defective products are detected from the same assembly lot of ROHM, an emergency response will be conducted. The contents of the emergency response will be decided upon consultation with the customer.
- 8) If the customer conducts an analysis and/or investigation of this product and detects a non-conformity that impairs the initial performance or function of this product, ROHM will reply to the customer's questions and/or take actions to improve the non-conformity.
- 9) Changes to 5M (Men, Method, Machine, Material, and Measurement) will be notified to customers 90days in advance if ROHM determines that the change will have a significant impact on the product's performance, functions, or reliability.
- 10) Discontinuation/EOL of this product will be notified at least 6 months before the final order deadline and at least 12 months before the final shipment day. ROHM will support a last time buy if the customer places a final order before the final order deadline and ROHM accepts. ROHM will ship the amount of the final order until the final shipment day. However, the maximum order quantity that ROHM will support is restricted to ROHM's production capacity and the quantity of material available.
- 11) Since the reliability test to estimate this product's lifetime is done by sampling inspections, the capability of all products is not guaranteed.



## Notes

- 1) The information contained herein is subject to change without notice.
- 2) Before you use our Products, please contact our sales representative and verify the latest specifications :
- 3) Although ROHM is continuously working to improve product reliability and quality, semiconductors can break down and malfunction due to various factors.  
Therefore, in order to prevent personal injury or fire arising from failure, please take safety measures such as complying with the derating characteristics, implementing redundant and fire prevention designs, and utilizing backups and fail-safe procedures. ROHM shall have no responsibility for any damages arising out of the use of our Products beyond the rating specified by ROHM.
- 4) Examples of application circuits, circuit constants and any other information contained herein are provided only to illustrate the standard usage and operations of the Products. The peripheral conditions must be taken into account when designing circuits for mass production.
- 5) The technical information specified herein is intended only to show the typical functions of and examples of application circuits for the Products. ROHM does not grant you, explicitly or implicitly, any license to use or exercise intellectual property or other rights held by ROHM or any other parties. ROHM shall have no responsibility whatsoever for any dispute arising out of the use of such technical information.
- 6) The Products are intended for use in general electronic equipment (i.e. AV/OA devices, communication, consumer systems, gaming/entertainment sets) as well as the applications indicated in this document.
- 7) The Products specified in this document are not designed to be radiation tolerant.
- 8) For use of our Products in applications requiring a high degree of reliability (as exemplified below), please contact and consult with a ROHM representative : transportation equipment (i.e. cars, ships, trains), primary communication equipment, traffic lights, fire/crime prevention, safety equipment, medical systems, servers, solar cells, and power transmission systems.
- 9) Do not use our Products in applications requiring extremely high reliability, such as aerospace equipment, nuclear power control systems, and submarine repeaters.
- 10) ROHM shall have no responsibility for any damages or injury arising from non-compliance with the recommended usage conditions and specifications contained herein.
- 11) ROHM has used reasonable care to ensure the accuracy of the information contained in this document. However, ROHM does not warrant that such information is error-free, and ROHM shall have no responsibility for any damages arising from any inaccuracy or misprint of such information.
- 12) Please use the Products in accordance with any applicable environmental laws and regulations, such as the RoHS Directive. For more details, including RoHS compatibility, please contact a ROHM sales office. ROHM shall have no responsibility for any damages or losses resulting from non-compliance with any applicable laws or regulations.
- 13) When providing our Products and technologies contained in this document to other countries, you must abide by the procedures and provisions stipulated in all applicable export laws and regulations, including without limitation the US Export Administration Regulations and the Foreign Exchange and Foreign Trade Act.
- 14) This document, in part or in whole, may not be reprinted or reproduced without prior consent of ROHM.



Thank you for your accessing to ROHM product informations.  
More detail product informations and catalogs are available, please contact us.

## ROHM Customer Support System

<http://www.rohm.com/contact/>