

***TSC2200 Touch Screen Controller
Evaluation Module***

User's Guide

THIS PAGE INTENTIONALLY LEFT BLANK

IMPORTANT NOTICE

Texas Instruments and its subsidiaries (TI) reserve the right to make changes to their products or to discontinue any product or service without notice, and advise customers to obtain the latest version of relevant information to verify, before placing orders, that information being relied on is current and complete. All products are sold subject to the terms and conditions of sale supplied at the time of order acknowledgment, including those pertaining to warranty, patent infringement, and limitation of liability.

TI warrants performance of its products to the specifications applicable at the time of sale in accordance with TI's standard warranty. Testing and other quality control techniques are utilized to the extent TI deems necessary to support this warranty. Specific testing of all parameters of each device is not necessarily performed, except those mandated by government requirements.

Customers are responsible for their applications using TI components.

In order to minimize risks associated with the customer's applications, adequate design and operating safeguards must be provided by the customer to minimize inherent or procedural hazards.

TI assumes no liability for applications assistance or customer product design. TI does not warrant or represent that any license, either express or implied, is granted under any patent right, copyright, mask work right, or other intellectual property right of TI covering or relating to any combination, machine, or process in which such products or services might be or are used. TI's publication of information regarding any third party's products or services does not constitute TI's approval, license, warranty or endorsement thereof.

Reproduction of information in TI data books or data sheets is permissible only if reproduction is without alteration and is accompanied by all associated warranties, conditions, limitations and notices. Representation or reproduction of this information with alteration voids all warranties provided for an associated TI product or service, is an unfair and deceptive business practice, and TI is not responsible nor liable for any such use.

Resale of TI's products or services with statements different from or beyond the parameters stated by TI for that product or service voids all express and any implied warranties for the associated TI product or service, is an unfair and deceptive business practice, and TI is not responsible nor liable for any such use.

Also see: Standard Terms and Conditions of Sale for Semiconductor Products. www.ti.com/sc/docs/stdterms.htm

Mailing Address:

Texas Instruments
Post Office Box 655303
Dallas, Texas 75265

Copyright © 2001, Texas Instruments Incorporated

EVM IMPORTANT NOTICE

Texas Instruments (TI) provides the enclosed product(s) under the following conditions:

This evaluation kit being sold by TI is intended for use for **ENGINEERING DEVELOPMENT OR EVALUATION PURPOSES ONLY** and is not considered by TI to be fit for commercial use. As such, the goods being provided may not be complete in terms of required design-, marketing-, and/or manufacturing-related protective considerations, including product safety measures typically found in the end product incorporating the goods. As a prototype, this product does not fall within the scope of the European Union directive on electromagnetic compatibility and therefore may not meet technical requirements of the directive.

Should this evaluation kit not meet specifications indicated in the EVM User's Guide, the kit may be returned within 30 days from the date of delivery for a full refund. THE FOREGOING WARRANTY IS THE EXCLUSIVE WARRANTY MADE BY THE SELLER TO THE BUYER AND IS IN LIEU OF ALL OTHER WARRANTIES, EXPRESSED, IMPLIED, OR STATUTORY, INCLUDING ANY WARRANTY OF MERCHANTABILITY OR FITNESS FOR ANY PARTICULAR PURPOSE.

The user assumes all responsibility and liability for proper and safe handling of the goods. Further, the user indemnifies TI from all claims arising from the handling or use of the goods. Please be aware that the products received may not be regulatory compliant or agency certified (FCC, UL, CE, etc.). Due to the open construction of the product, it is the user's responsibility to take any and all appropriate precautions with regard to electrostatic discharge.

EXCEPT TO THE EXTENT OF THE INDEMNITY SET FORTH ABOVE, NEITHER PARTY SHALL BE LIABLE TO THE OTHER FOR ANY INDIRECT, SPECIAL, INCIDENTAL, OR CONSEQUENTIAL DAMAGES.

TI currently deals with a variety of customers for products, and therefore our arrangement with the user **is not exclusive**.

TI assumes **no liability for applications assistance, customer product design, software performance, or infringement of patents or services described herein**.

Please read the EVM User's Guide and, specifically, the EVM Warnings and Restrictions notice in the EVM User's Guide prior to handling the product. This notice contains important safety information about temperatures and voltages. For further safety concerns, please contact the TI application engineer.

Persons handling the product must have electronics training and observe good laboratory practice standards.

No license is granted under any patent right or other intellectual property right of TI covering or relating to any machine, process, or combination in which such TI products or services might be or are used.

Mailing Address:

Texas Instruments
Post Office Box 655303
Dallas, Texas 75265

Copyright © 2001, Texas Instruments Incorporated

EVM WARNINGS AND RESTRICTIONS

It is important to operate this EVM within the input voltage range of 6V to 12V and the output voltage range of 5V.

Exceeding the specified input range may cause unexpected operation and/or irreversible damage to the EVM. If there are questions concerning the input range, please contact a TI field representative prior to connecting the input power.

Applying loads outside of the specified output range may result in unintended operation and/or possible permanent damage to the EVM. Please consult the EVM User's Guide prior to connecting any load to the EVM output. If there is uncertainty as to the load specification, please contact a TI field representative.

During normal operation, some circuit components may have case temperatures greater than 40°C. The EVM is designed to operate properly with certain components above 40°C as long as the input and output ranges are maintained. These components include but are not limited to linear regulators, switching transistors, pass transistors, and current sense resistors. These types of devices can be identified using the EVM schematic located in the EVM User's Guide. When placing measurement probes near these devices during operation, please be aware that these devices may be very warm to the touch.

Mailing Address:

Texas Instruments
Post Office Box 655303
Dallas, Texas 75265

Copyright © 2001, Texas Instruments Incorporated

Read This First

About This Manual

This users guide describes the function and operation of the TSC2200 touch screen controller evaluation module. This manual will help you quickly set up the evaluation board and its accompanying software, so that you may rapidly test and evaluate the TSC2200. A complete circuit description, as well as schematic diagram and bill of materials, is included.

How to Use This Manual

This manual begins with an introductory chapter which describes the EVM and what it can do. If you're anxious to set things up and start testing, we suggest you read at least the first two chapters. These two chapters introduce you to the board and how to set it up to start working with it. Later chapters go into more detail on the board's design and how to access its many features.

Information About Cautions and Warnings

This book may contain cautions.

This is an example of a caution statement.

A caution statement describes a situation that could potentially damage your software or equipment.

CAUTION

The information in a caution is provided for your protection. Please read each caution carefully.

Related Documentation From Texas Instruments

Data Sheets:	Literature Number:
TSC2200	SBAS191
SN74AHC244	SCLS226
SN74LVC07A	SCAS595
REG1117	SBVS001

If You Need Assistance

If you have questions about this or other Texas Instruments data converter evaluation modules, feel free to e-mail the data converter application team at dataconvapps@list.ti.com. Include the product name in the subject heading.

FCC Warning

This equipment is intended for use in a laboratory test environment only. It generates, uses, and can radiate radio frequency energy and has not been tested for compliance with the limits of computing devices pursuant to subpart J of part 15 of FCC rules, which are designed to provide reasonable protection against radio frequency interference. Operation of this equipment in other environments may cause interference with radio communications, in which case the user at his own expense will be required to take whatever measures may be required to correct this interference.

If your book does not discuss a product that creates radio frequency interference, delete this section from your preface. If your book does discuss a product that creates radio frequency interference, you must include this warning as it appears above.

Trademarks

Windows is a trademark of Microsoft Corporation.

TouchTek 4 and MicroTouch are trademarks of 3M.

SPI is a registered trademark of Motorola.

Contents

Read This First	iv
About This Manual	iv
How to Use This Manual	iv
Information About Cautions and Warnings	iv
Related Documentation From Texas Instruments	v
If You Need Assistance	v
FCC Warning	v
Trademarks.....	v
Contents	vi
Figures	vii
Tables	vii
Introduction	1-1
1.1 Device Characteristics.....	1-2
1.2 EVM Block Diagram	1-2
1.3 Analog Inputs/Outputs.....	1-3
1.4 Prototyping Area	1-3
1.5 Power Requirements.....	1-3
1.6 Computer Requirements	1-3
Getting Started	2-1
2.1 Unpacking the EVM.....	2-2
2.2 Default Configuration.....	2-2
2.3 Quick Start	2-2
Operation	3-1
3.1 Jumpers	3-2
3.1.1 DAC Pull-up Voltage: Motherboard.....	3-2
3.1.2 DAC Pull-up Voltage: Daughter card	3-2
3.1.3 VDAC Output Selection	3-2
3.2 I/O Connectors and Signals.....	3-2
3.2.1 TSC100PM Motherboard Connectors.....	3-3
3.2.2 TSC2200EVM Daughter Card Connectors	3-8
3.3 Circuit Description	3-10
3.3.1 Power Supply	3-10
3.3.2 Digital Interface	3-10
3.3.3 Touch Screen and Analog Inputs.....	3-11
3.3.4 Keypad Interface	3-11
3.3.5 DAC Circuit	3-12
3.4 Program Description.....	3-13
3.4.1 Human Interface Screen	3-13
3.4.2 Configuration Screen	3-15
3.4.3 Data Acquisition Screen.....	3-18
Physical Description	4-1
4.1 Schematics.....	4-2
4.1.1 TSC100PM Motherboard	4-2
4.1.2 TSC2200EVM Daughter Card	4-3

4.2	Component Locations.....	4-4
4.2.1	TSC100PM Motherboard.....	4-4
4.2.2	TSC2200EVM Daughter Card	4-5
4.3	Bill of Materials	4-6
4.3.1	TSC100PM Motherboard.....	4-6
4.3.2	TSC2200EVM Daughter Card	4-8

Figures

Figure 1.	TSC2200 Evaluation Kit Block Diagram.....	1-2
Figure 2.	Default Software Screen	2-3
Figure 3.	Human Interface Screen	3-13
Figure 4.	Configuration Screen.....	3-15
Figure 5.	External Reference Selection	3-17
Figure 6.	Data Acquisition Screen	3-18
Figure 7.	TSC100PM Motherboard.....	4-2
Figure 8.	TSC2200EVM Daughter Card.....	4-3
Figure 9.	TSC100PM Motherboard.....	4-4
Figure 10.	TSC2200EVM Daughter Card.....	4-5

Tables

Table 1.	Default Configuration Settings.....	2-2
Table 2.	Jumper/Function Reference	3-2
Table 3.	Parallel Port Connector	3-3
Table 4.	External SPI Connector	3-4
Table 5.	Power Connectors	3-4
Table 6.	Power Interface Connector.....	3-5
Table 7.	Digital Interface Connector.....	3-5
Table 8.	Analog Input Connector	3-6
Table 9.	Touch screen Input Connector	3-6
Table 10.	I ² C Interface Connector	3-7
Table 11.	X-Y Interface Connector	3-7
Table 12.	DAC Connector	3-8
Table 13.	Power Interface Connector.....	3-8
Table 14.	Digital Interface Connector.....	3-9
Table 15.	I ² C Interface Connector	3-9
Table 16.	X-Y Interface Connector	3-10

THIS PAGE INTENTIONALLY LEFT BLANK

Introduction

The TSC2200 is an advanced touch screen controller, which communicates to a host processor through an SPI serial interface. The evaluation kit for this device, the TSC2200EVM, is designed to ease the digital interface to the TSC2200 by connecting to a personal computer running easy-to-use software which allows total access to the TSC2200's various control functions. The TSC2200EVM consists of a motherboard which connects to the PC (TSC100PM), and a daughter card with the TSC2200 and its associated circuitry (TSC2200EVM).

Topic	Page
Device Characteristics	1-2
EVM Block Diagram	1-2
Analog Inputs/Outputs	1-3
Prototyping Area	1-3
Power Requirements	1-3
Computer Requirements	1-3

1.1 Device Characteristics

The TSC2200 is a complete PDA analog interface circuit. It contains a complete 12-bit (A/D) resistive touch screen converter, including drivers, the control to measure touch pressure, a 4-by-4 matrix keyboard controller, and 8-bit DAC output for LCD contrast control. The TSC2200 interfaces to the host controller through a standard SPI serial interface. The TSC2200 also offers two battery measurement inputs capable of reading battery voltages up to 6V, while operating with only a 2.7V supply. It also has an on-chip temperature sensor capable of reading 0.3 degrees C resolution.

1.2 EVM Block Diagram

A block diagram of the TSC2200 evaluation kit is shown in Figure 1. The evaluation kit consists of two circuit boards connected together. The motherboard is designated as the TSC100PM, while the daughter card is designated as the TSC2200EVM.

Figure 1. TSC2200 Evaluation Kit Block Diagram.

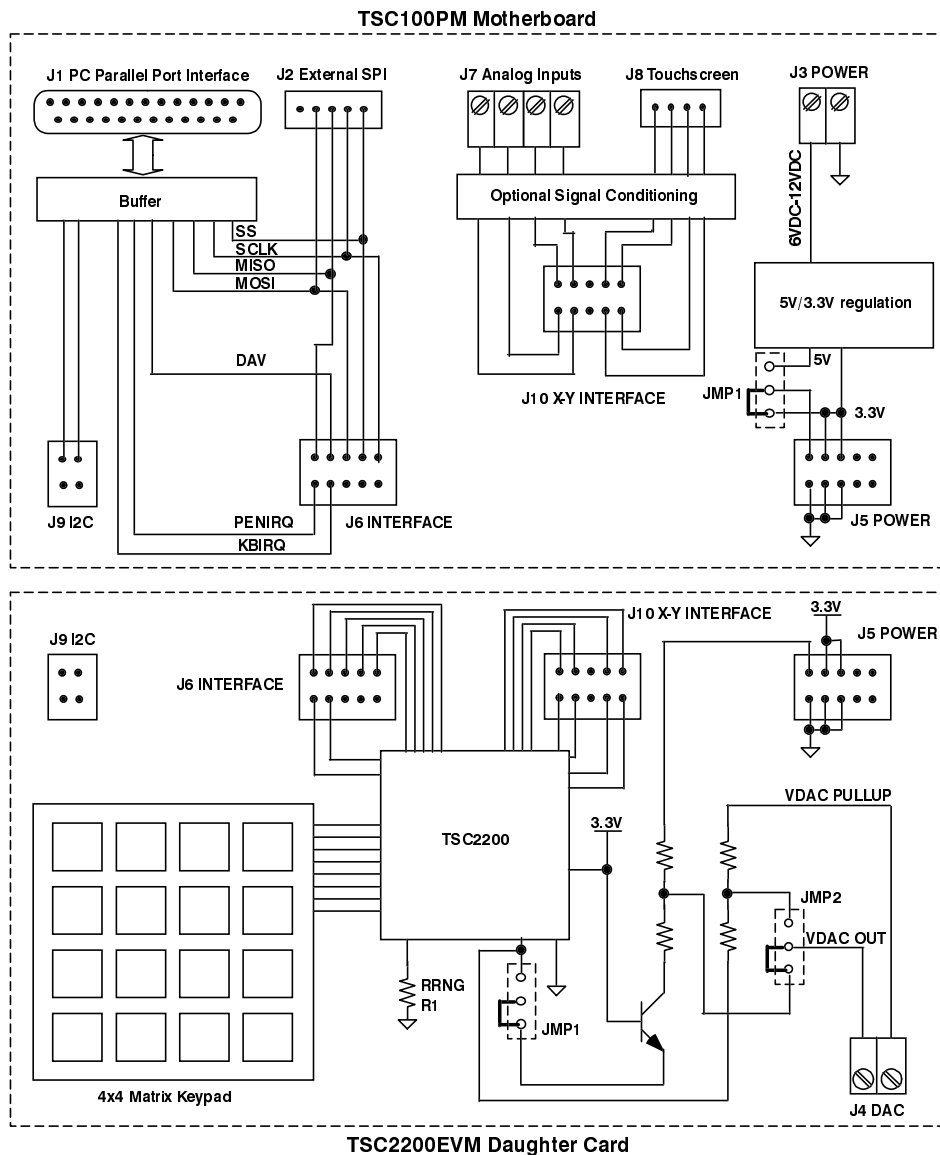

The digital control interface is either through the PC parallel port, or an external SPI bus. The PC parallel port can be disabled, allowing the external SPI bus to control the TSC2200. When using the PC parallel port or the external SPI bus, the digital signals are level converted to the digital interface voltage of 3.3V.

Power supplies are to be provided to the kit through external connectors from an external, user-supplied laboratory power supply.

1.3 Analog Inputs/Outputs

Touch screen inputs are provided to the controller through J8 on the motherboard. This connector is standard on 3M Touch Systems (formerly MicroTouch) TouchTek 4 touch screens. The other analog inputs are brought onto the board through the J7 terminal block. The AUX1 and AUX2 inputs must be between 0V and 3.3V, while the battery inputs, VBAT1 and VBAT2 may range from 0V to 6V.

1.4 Prototyping Area

The daughter card that carries the TSC2200 has a small prototyping area on it. This may be used to build small signal conditioning circuits if the TSC2200EVM's options do not provide adequate simulation of the user's system.

1.5 Power Requirements

The TSC100PM motherboard requires 6VDC to 12VDC to be provided by the user either through the J3 terminal block or the J4 barrel jack. If J4 is used with a wall adapter type AC/DC supply, the connector must be configured with the center terminal positive.

1.6 Computer Requirements

The TSC2200EVM software is designed to run on a PC running any Windows® platform (Windows 95, 98, NT, 2000, etc).

Minimum Requirements:

- IBM-Compatible 486 PC or Higher
- Windows 95, 98, 2000 or NT4.0
- 64MB RAM Minimum
- 20MB Available Hard Disk Space
- CD-ROM Drive
- Available Parallel Port

THIS PAGE INTENTIONALLY LEFT BLANK

Getting Started

This chapter will guide you through unpacking your EVM, and setting it up so you can begin working with it immediately.

Topic	Page
Unpacking the EVM	2-2
Default Configuration	2-2
Quick Start	2-2

2.1 Unpacking the EVM

After unpacking the TSC2200EVM, check to make sure you received all the material that should be in the box. The EVM kit should include the following:

- TSC100PM board, PWB 6434953, with attached TSC2200EVM board, PWB 6434947
- CD-ROM, 6437055
- IEEE1284 Cable

If any of these components are missing, contact Texas Instruments for a replacement.

2.2 Default Configuration

The TSC100PM and TSC2200EVM feature a few simple means of configuring their operation. The configuration details needed are the settings of the one jumper on the TSC100PM motherboard, and the two jumpers and the value of R1, the DAC range setting resistor, on the TSC2200EVM daughter card.

The default settings for these items are shown in Table 1. When you unpack your TSC2200EVM, make sure that your board is configured as shown here initially.

Table 1. Default Configuration Settings

Board	Board Identifier	Description	Default Setting
TSC100PM	JMP1	DAC Pull-Up Voltage	1 to 2
TSC2200EVM	JMP1	DAC On-Board Pull-Up	2 to 3
TSC2200EVM	JMP2	DAC Output From On-Board Pull-Up	2 to 3
TSC2200EVM	R1	DAC Range Resistor	100k Ω

These settings will allow the DAC voltage, VD_{DAC}, present at J4 of the daughter card to range from 4.1V to 5V.

2.3 Quick Start

Once the TSC2200EVM has been unpacked from its shipping container, and you have verified that the board is configured as shown in Table 1, it can be connected to the power supply.

Connect wires from the terminal block J3 to a laboratory power supply set to supply between 6VDC and 12VDC. Make sure to observe correct polarity; the polarity for the terminal block is marked on the printed circuit board. Do not turn on the power supply at this time.

Connect the IEEE1284 cable to your PC, but do not connect it to the TSC100PM board yet.

Place the CD-ROM into your PC's CD-ROM drive. Locate the Setup program on the disk, and run it. The Setup program will install the TSC2200EVM software on your PC. Note that if you are running a Windows platform that is NT-based, you will need administrator privileges to install the software. Follow the instructions that the installer gives you.

When the installation is complete, turn on the power supply, then connect the parallel port cable to the TSC100PM. Once these connections have been made, launch the TSC2200EVM software on your PC.

The software should automatically determine the parallel port where the TSC2200EVM is connected. If the board is found, the screen shown in Figure 2 will appear.

Figure 2. Default Software Screen.

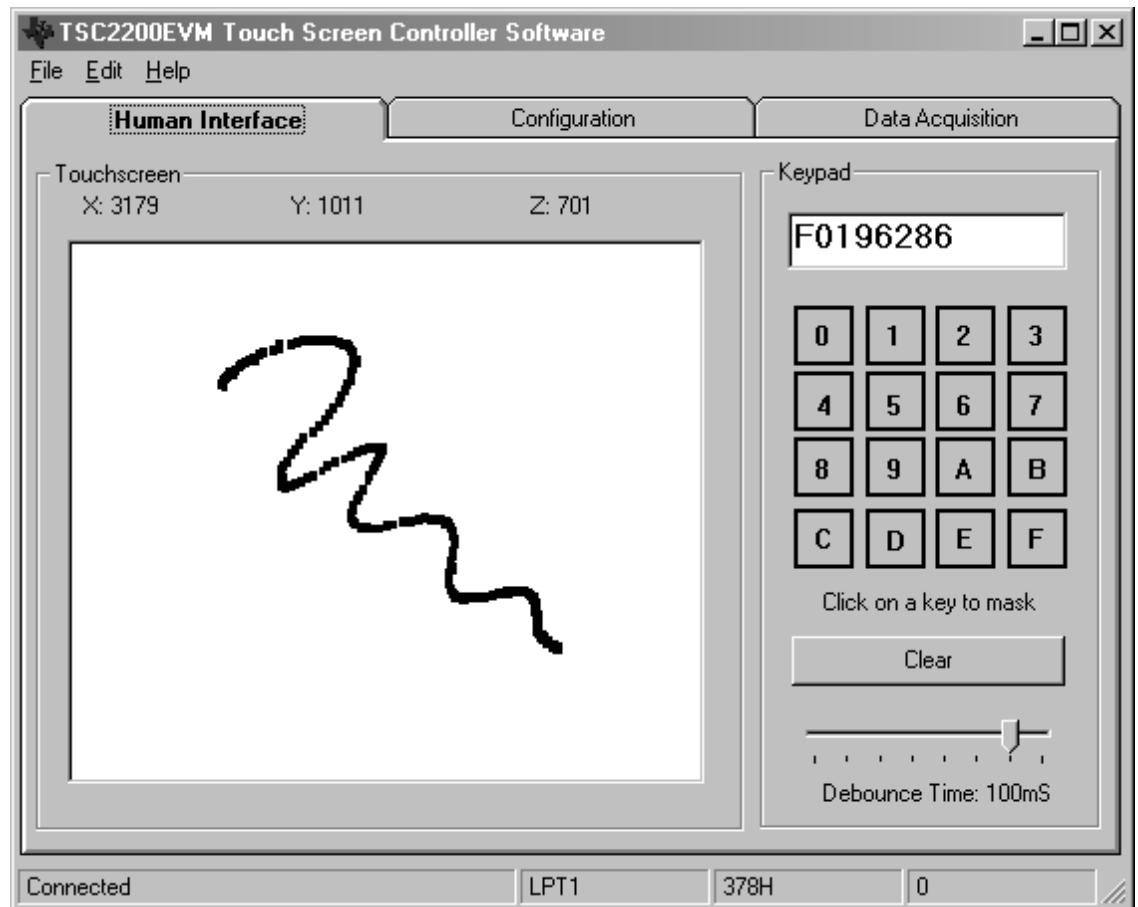

In order to use the touch screen features, a 4-wire resistive touch screen will need to be connected to J8 of the motherboard.

THIS PAGE INTENTIONALLY LEFT BLANK

Operation

This chapter describes each function of the TSC2200 evaluation kit, and how to use the accompanying software to control and use the TSC2200.

Topic	Page
Jumpers	3-2
I/O Connectors and Signals	3-2
Circuit Descriptions	3-10
Program Descriptions	3-11

3.1 Jumpers

The following table shows the function of each jumper on the EVM:

Table 2. Jumper/Function Reference.

Board	Reference Designator	Setting	Function	Subsection
TSC100PM	JMP1	1 to 2	DAC Pull-Up Voltage = 5V	3.1.1
		2 to 3	DAC Pull-Up Voltage = 3.3V	
TSC2200EVM	JMP1	1 to 2	DAC Pull-Up Connected to R3	3.1.2
		2 to 3	DAC Pull-Up Connected to Q1	
TSC2200EVM	JMP2	1 to 2	VDAC Output Connected to R3/R5	3.1.3
		2 to 3	VDAC Output Connected to R4/R6	

3.1.1 DAC Pull-up Voltage: Motherboard

The TSC100PM motherboard can supply either +5V or +3.3V to the daughter card for use as the pull-up voltage for the TSC2200's digital-to-analog converter (DAC). This selection is made on the TSC100PM through JMP1.

3.1.2 DAC Pull-up Voltage: Daughter card

The TSC2200EVM daughter card has provisions for two different DAC pull-up circuits. The first circuit is R3 and R5, which are to be user-installed and connected to a pull-up voltage connected to the V+ input at J4 on the TSC2200EVM daughter card. The voltage V+ must be less than or equal to the supply voltage for the TSC2200, which is nominally +3.3V. This circuit is chosen by connecting positions 1 and 2 on JMP1 of the daughter card.

The on-board resistors, R4 and R6, are connected to the DAC voltage provided by the motherboard. Since the motherboard can supply a voltage higher than the supply voltage of the TSC2200, Q1 is used to protect the TSC2200. This circuit is chosen by connecting positions 2 and 3 on JMP1 of the daughter card.

3.1.3 VDAC Output Selection

JMP2 on the daughter card selects which resistor network connected to the DAC will be connected to the VDAC output on connector J4. Positions 1 and 2 connected will select the user-supplied R3/R5 resistor array, while positions 2 and 3 connected together select the on-board resistor network of R4/R6.

3.2 I/O Connectors and Signals

The various connectors on the TSC2200EVM are described in this section.

3.2.1 TSC100PM Motherboard Connectors

3.2.1.1 Parallel Port Connector

The connector for use with the PC parallel port is described in Table 3. This connector provides a means of communicating with the PC through an IEEE-1284 cable.

Table 3. Parallel Port Connector.

Reference Designator	Description	Pin Number	Signal Name	Function
J1	Digital communication port between the TSC2200EVM and a host PC.	1	$\overline{\text{EVM_ENABLE}}$	Enables the SPI bus control from the PC.
		2	$\overline{\text{SS}}$	Slave Select for SPI bus.
		3	SCLK	Serial Clock for SPI bus.
		4	MOSI	Master Out, Slave In data line for SPI bus. Data travels to the TSC2200 over this line.
		5 - 9	NC	Not Connected
		10	$\overline{\text{DAV}}$	Data Available line from TSC2200.
		11	SDA_IN	Serial Data from I ² C data bus to PC (not used for this EVM).
		12	$\overline{\text{PENIRQ}}$	Pen Interrupt line from TSC2200.
		13	$\overline{\text{KBIRQ}}$	Keyboard interrupt line from TSC2200.
		14	SCL	Serial Clock line for I ² C interface (not used for this EVM).
		15	MISO	Master In, Slave Out data line for SPI bus. Data travels from the TSC2200 over this line.
		16	SDA_OUT	Serial Data from PC to I ² C data bus (not used for this EVM).
		17	NC	Not Connected.
18-25	GND	Ground.		

3.2.1.2 External SPI Connector

If the SPI bus is not controlled from the PC, it may be controlled through J2. The user might connect an external microprocessor or DSP to the TSC2200EVM through this connector.

Table 4. External SPI Connector.

Reference Designator	Description	Pin Number	Signal Name	Function
J2	Digital communication port between the TSC2200 and an external processor	1	NC	Not Connected
		3	\overline{SS}	Slave Select for SPI bus.
		5	SCLK	Serial Clock for SPI bus.
		7	MOSI	Master Out, Slave In data line for SPI bus. Data travels to the TSC2200 over this line.
		9	MISO	Master In, Slave Out data line for SPI bus. Data travels from the TSC2200 over this line.
		2, 4, 6, 8, 10	GND	Ground

3.2.1.3 Power Connectors

Table 5. Power Connectors.

Reference Designator	Name	Description
J3	VDD IN	6V-12VDC input
J4	VDD IN	6V-12VDC input, positive center terminal

3.2.1.4 Power Interface Connector for Daughter Card

The motherboard supplies the various power supply voltages to the daughter card through this connector.

Table 6. Power Interface Connector.

Reference Designator	Description	Pin Number	Signal Name	Function
J5	Power supply connections between TSC100PM motherboard and TSC2200EVM daughter card.	1-4	NC	Not Connected
		5, 7	DV _{DD}	+3.3V supply
		9	DAC Pull-up	Supplies pull-up voltage to DAC resistor network on daughter card.
		6, 8, 10	GND	Ground

3.2.1.5 Digital Interface Connector for Daughter Card

Table 7. Digital Interface Connector.

Reference Designator	Description	Pin Number	Signal Name	Function
J6	Digital communication port between the TSC2200EVM daughter card and the TSC100PM.	1	SCLK	Serial Clock for SPI bus.
		3	\overline{SS}	Slave Select for SPI bus.
		5	MOSI	Master Out, Slave In data line for SPI bus. Data travels to the TSC2200 over this line.
		7	\overline{DAV}	Data Available line from the TSC2200.
		8	\overline{KBIRQ}	Keyboard interrupt line from the TSC2200.
		9	MISO	Master In, Slave Out data line for SPI bus. Data travels from the TSC2200 over this line.
		10	\overline{PENIRQ}	Pen Interrupt line from the TSC2200.
		2,4, 6	NC	Not Connected

3.2.1.6 Analog Input Connector

The auxiliary and battery inputs to the touch screen controller are brought onto the motherboard through a terminal block, J7. The pinout is shown in Table 8.

Table 8. Analog Input Connector.

Reference Designator	Description	Pin Number	Signal Name	Function
J7	Battery and auxiliary inputs to the touch screen control.	1	VBAT1	Battery Input 1, 0V to 6V
		2	VBAT2	Battery Input 2, 0V to 6V
		3	AUX1	Auxiliary Input 1, 0V to VREF
		4	AUX2	Auxiliary Input 2, 0V to VREF

3.2.1.7 Touch Screen Connector

A 4-wire touch screen connects to the motherboard through connector J8. This connector is standard on 3M Touch Systems (formerly MicroTouch) TouchTek 4 touch screens.

Table 9. Touch screen Input Connector.

Reference Designator	Description	Pin Number	Signal Name	Function
J8	Touch screen Input.	1	X-	Touch Screen X - Electrode
		2	Y+	Touch Screen Y + Electrode
		3	X+	Touch Screen X+ Electrode
		4	Y-	Touch Screen Y- Electrode

3.2.1.8 I²C Interface Connector

The TSC100PM may have a daughter card which uses an I²C interface. Provisions are made for supplying this interface from the PC parallel port, and this I²C interface is supplied to the daughter card through this connector.

Table 10. I²C Interface Connector.

Reference Designator	Description	Pin Number	Signal Name	Function
J9	I ² C interface connection to daughter card.	1	SDA	Serial Data Line
		3	SCL	Serial Clock Line
		2, 4	NC	No Connection

3.2.1.9 X-Y Interface Connector

The analog signals to the touch screen controller are carried on this connector.

Table 11. X-Y Interface Connector.

Reference Designator	Description	Pin Number	Signal Name	Function
J10	Analog interface to touch screen controller.	1	X+	X+ Signal From Touch Screen
		2	X-	X- Signal From Touch Screen
		3	Y+	Y+ Signal From Touch Screen
		4	Y-	Y- Signal From Touch Screen
		5, 6	NC	No Connection
		7	VBAT1	Battery 1 Input From J7
		8	VBAT2	Battery 2 Input From J7
		9	AUX1	Auxiliary Input 1 From J7
		10	AUX2	Auxiliary Input 2 From J7

3.2.2 TSC2200EVM Daughter Card Connectors

3.2.2.1 DAC Connector

The TSC2200 DAC requires an external resistor network, pulled up to a bias voltage. This voltage can be applied at J4, and the resulting output voltage from the DAC is also available on J4.

Table 12. DAC Connector.

Reference Designator	Description	Pin Number	Signal Name	Function
J4	DAC voltage connections.	1	V+	Pull-Up Voltage For DAC Resistor Network
		2	VDAC	DAC Voltage Output

3.2.2.2 Power Interface Connector

Table 13. Power Interface Connector.

Reference Designator	Description	Pin Number	Signal Name	Function
J5	Power supply connections between TSC100PM motherboard and TSC2200EVM daughter card.	1	LCD_BIAS_CNTL	Output voltage from DAC, commonly used for LCD bias control.
		3	24V ENABLE	Logic line to enable a DC/DC converter. Not used in this kit.
		2,4	NC	Not Connected
		5, 7	DV _{DD}	+3.3V Supply
		9	DAC Pull-up	Supplies pull-up voltage to DAC resistor network on daughter card.
		6, 8, 10	GND	Ground

3.2.2.3 Digital Interface Connector

Table 14. Digital Interface Connector.

Reference Designator	Description	Pin Number	Signal Name	Function
J6	Digital communication port between the TSC2200EVM daughter card and the TSC100PM.	1	SCLK	Serial Clock for SPI Bus.
		3	\overline{SS}	Slave Select for SPI Bus.
		5	MOSI	Master Out, Slave In data line for SPI bus. Data travels to the TSC2200 over this line.
		7	\overline{DAV}	Data Available Line From TSC2200.
		8	\overline{KBIRQ}	Keyboard Interrupt Line From TSC2200.
		9	MISO	Master In, Slave Out data line for SPI bus. Data travels from the TSC2200 over this line.
		10	\overline{PENIRQ}	Pen Interrupt Line From TSC2200.
		2, 4, 6	NC	Not Connected

3.2.2.4 I²C Interface Connector

Table 15. I²C Interface Connector.

Reference Designator	Description	Pin Number	Signal Name	Function
J9	I ² C interface connection to daughter card.	1	SDA	Serial Data Line
		3	SCL	Serial Clock Line
		2, 4	NC	No Connection

3.2.2.5 X-Y Interface Connector

Table 16. X-Y Interface Connector.

Reference Designator	Description	Pin Number	Signal Name	Function
J10	Analog interface to touch screen controller.	1	X+	X+ Signal From Touch Screen
		2	X-	X- Signal From Touch Screen
		3	Y+	Y+ Signal From Touch Screen
		4	Y-	Y- Signal From Touch Screen
		5, 6	NC	No Connection
		7	VBAT1	Battery 1 Input From J7
		8	VBAT2	Battery 2 Input From J7
		9	AUX1	Auxiliary Input 1 From J7
		10	AUX2	Auxiliary Input 2 From J7

3.3 Circuit Description

The TSC2200 evaluation kit consists of the TSC100PM motherboard and the TSC2200EVM daughter card. Taken together, the circuit breaks down into a power supply, a digital interface, a touch screen and analog inputs interface, a keypad interface, and a DAC circuit. These circuits are described below.

3.3.1 Power Supply

Power to the TSC100PM motherboard can be supplied through the J3 terminal block, or the J4 barrel jack connector. 6VDC to 12VDC must be supplied. Since it is regulated on the TSC100PM, this input voltage does not need to be regulated, as long as it falls within this range. D1 prevents a power supply which is connected with the wrong polarity from damaging the board.

U2 and U3 regulate the input supply voltage to provide 5V and 3.3V, respectively. Each regulated supply voltage has an LED attached which will alert the user that the supply is working.

3.3.2 Digital Interface

The SPI interface to the TSC100PM motherboard can be controlled from two sources: the external SPI header, J2, or from the PC parallel port, J1. The PC parallel port connection is buffered through U1. U1's outputs are enabled only when pin 1 of U1 is LOW. This pin

is pulled HIGH by R1, so that if no parallel port is connected, U1's outputs are tri-stated, allowing the external SPI bus to drive the TSC2200. When the PC parallel port is connected, the PC software will pull pin 1 of the parallel port, which is connected to pin 1 of U1, LOW in order to enable the PC to control the SPI bus.

Do not drive the external SPI bus when the PC parallel port is connected. Disconnect the PC parallel port cable from the TSC100PM if you want to use the external SPI bus.

CAUTION

Each signal from the SPI inputs is buffered through open drain buffers (U4, U5). These buffers translate the input signals to 3.3V logic levels to drive the touch screen controller; likewise, output signals from the controller are translated to 5V logic levels. These signals are all connected to J6, the digital interface to the daughter card. On the daughter card, these signals are connected directly to the TSC2200.

An I²C interface is provided from the PC parallel port, and this too is level shifted so that logic levels to the device are 3.3V logic, and logic levels to the PC are 5V. The I²C signals are routed to J9, the I²C interface to the daughter card. On the daughter card, these signals are routed to a footprint for a 24LC64 EEPROM, which is not installed. This is to allow for extra functionality for future applications.

3.3.3 Touch Screen and Analog Inputs

On the motherboard, terminal block J7 provides input connection points for the battery and auxiliary inputs. Battery inputs may range from 0VDC to 6VDC, and the auxiliary inputs can range from 0VDC to 2.5VDC. The touch screen can be connected to J8 on the motherboard.

Each of these eight inputs has provision for an RC filter to be placed in line with the signal. As shipped, all the resistors are 0Ωs, and the capacitors are not installed. If noisy conditions prevent obtaining good readings from the TSC2200, 0.1μF capacitors may be installed in positions C6 through C13. If more filtering is required, the 0Ω resistors should be unsoldered from the board and replaced with small resistors. Note that increasing the capacitance on the touch screen inputs will require increased panel voltage stabilization time, as well as increased precharge and sense times, thus lowering the available number of readings per second.

The filtered signals for all the analog inputs are routed to J10, the X-Y Interface to the daughter card. On the daughter card, these signals are connected directly to the TSC2200.

3.3.4 Keypad Interface

A 4x4 matrix keypad is on the daughter card. This keypad connects directly to the TSC2200. No other circuitry is needed since the TSC2200 contains all the keypad control circuitry.

3.3.5 DAC Circuit

The TSC2200 contains a current-output DAC, which is designed to be used with a two resistor pull-up network to turn the current into a voltage. The details of the operation of this DAC can be found in the TSC2200 data sheet.

On this board, provisions are made for the user to provide these two resistors, in R3 and R5 sockets on the daughter card. These can be connected to an external pull-up voltage, which is provided through J4 on the daughter card.

On the daughter card, R4 and R6 are installed. When the DAC pull-up voltage is selected to be 5V, the range for the DAC output voltage, also available on J4, is 4.1V to 5V, with the factory installed resistor value of 100k Ω for R1.

R1 is the range setting resistor for the TSC2200 DAC, and is installed in a socket so that it can be replaced with a different value. With the factory installed value of 100k Ω , the DAC has a range of 600uA.

3.4 Program Description

After having installed the software for the TSC2200EVM as described in section 2.3, you may begin using it to evaluate and develop with the TSC2200.

3.4.1 Human Interface Screen

The program's interface is a simple, three-tab interface. Clicking on a tab will take you to the functions associated with that tab. The default tab which the program begins on is the Human Interface tab, as shown in Figure 3.

Figure 3. Human Interface Screen.

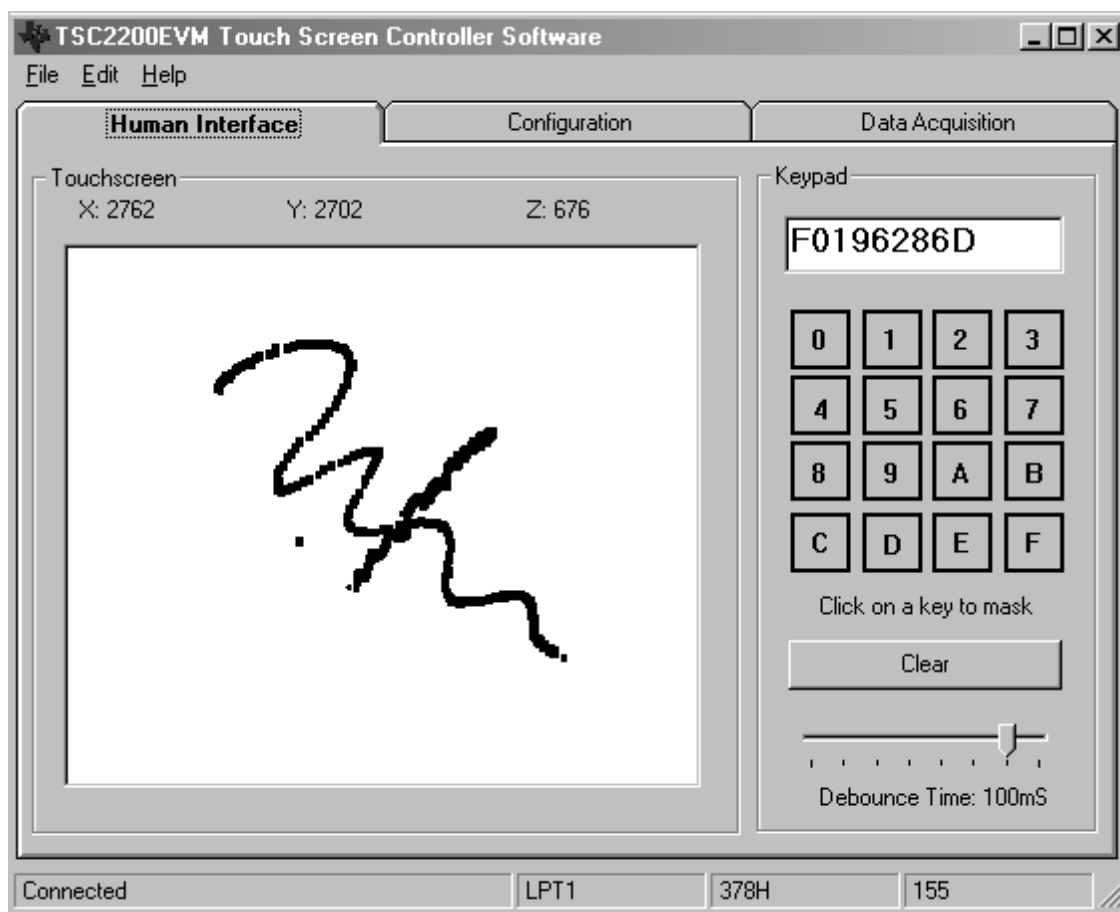

This screen reflects the touch screen and keypad inputs from the TSC2200EVM. The status bar on the bottom of the screen is divided into four sections, and shows the status of communication between the PC and the motherboard. Starting from the left, the first section shows the status of the connection; if an error in communication occurs, an error message will appear here, otherwise it will look as shown in Figure 3. The next section of the status bar shows the parallel port that the EVM was found on, and the section next to that is the hexadecimal value of the base address of that port. The final section, on the right side of the status bar, shows the number of readings per second being taken from the touch screen. This value will drop to zero when no screen touch is detected.

3.4.1.1 Touch Screen Section

The touch screen box on this screen will be updated when a touch is detected on the touch screen. As the touch screen is drawn upon, the motion on the touch screen will be translated into pixels on the screen. The software takes X, Y, and Z readings, which are shown at the top of this box. As the touch pressure is increased, the pixel size increases; a lighter touch results in smaller pixel sizes.

The display can be cleared by pressing the Enter or Delete keys on the PC keyboard.

3.4.1.2 Keypad Section

The keypad functions of the TSC2200 are controlled from this section of the screen. As keys on the keypad of the EVM are pressed, the keypresses are displayed in the display near the top of this box. The keymap shown here will also reflect keypresses on the EVM. The display can be cleared by pressing the Clear button in this box.

Individual keys can be masked by clicking on the key in the keymap on this screen. The key label will change to an "X" to reflect that the key is masked. When a key is masked, pressing that key on the keypad on the EVM will not result in the keypress being detected. To unmask a key which was masked, simply click on the key in the keymap again, and the key label will return to its corresponding value.

The debounce time for the keypad can be set using the slider in this section. The debounce time can range from 2ms to 120ms. Note that using short debounce times will result in a single keypress generating multiple keypress events.

3.4.2 Configuration Screen

This screen gives access to all the configurable settings for the TSC2200's A/D converter, reference and DAC, as shown in Figure 4.

Figure 4. Configuration Screen.

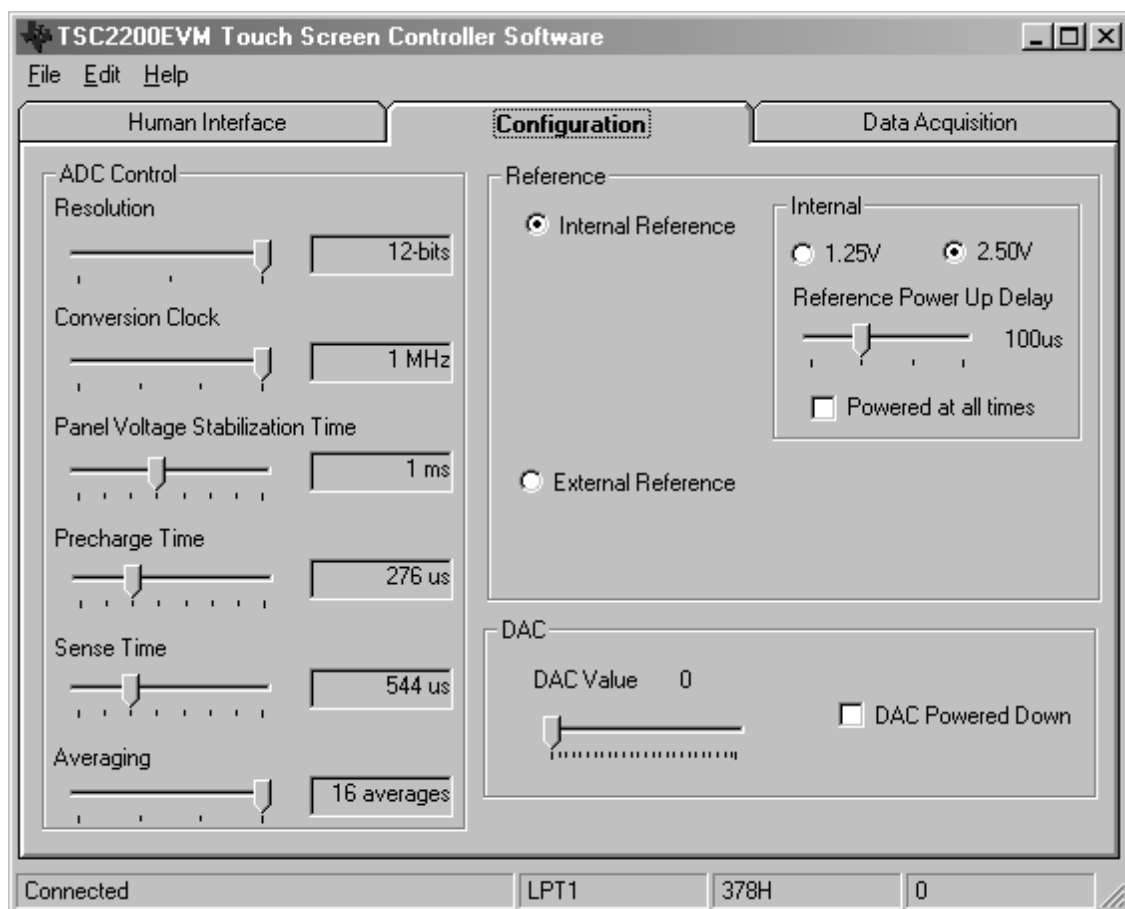

3.4.2.1 A/D Converter Control Section

This section controls all the parameters of the A/D converter. Each slider controls one parameter, whose value is shown next to the slider. Each slider is described below.

Resolution

Selects between 8, 10, and 12 bit resolution.

Conversion Clock

The internal clock which runs the A/D converter can run at 8-, 4-, 2-, or 1MHz. When running at 8MHz, only 8-bit resolution is possible; when running at 4MHz, 8- or 10-bit resolution is possible, but 12-bit is not. These restrictions are reflected in the

operation of this program, since only 1MHz or 2MHz clock rates will allow 12-bit resolution to be chosen.

Panel Voltage Stabilization Time

This is the time that the TSC2200 allows for the touch screen to settle after turning the drivers on.

Precharge Time

Sense Time

These two parameters are the time allowed to precharge the touch panel capacitance and then sense to see if the screen is touched. For more details on these parameters, refer to the TSC2200 data sheet.

Averaging

Several readings may be taken and then averaged to give a single result. No averaging can be chosen, or 4, 8, or 16 readings can be averaged.

Note that these settings apply to all operations of the A/D converter, not just the touch screen operations. Thus, resolution and averaging can be changed to increase accuracy in the data acquisition functions.

3.4.2.2 Reference Section

The touch screen function is always performed using a ratiometric mode; for all other A/D functions, a reference voltage is needed for the A/D converter. Figure 4 shows this section with the TSC2200's internal reference chosen. This reference voltage can be set to either 1.25V or 2.5V.

The internal reference powers down between conversions, to save power. Using the *Powered at all times* checkbox, this can be overridden and the reference will not power down. If the reference is allowed to power down, the TSC2200 then must allow a delay time for the reference to power up when a conversion is to take place. This delay time can be set using the slider in this section.

If an external reference is to be used, it may be selected as shown in Figure 5. The value of the external reference should be entered in the text box shown.

Figure 5. External Reference Selection.

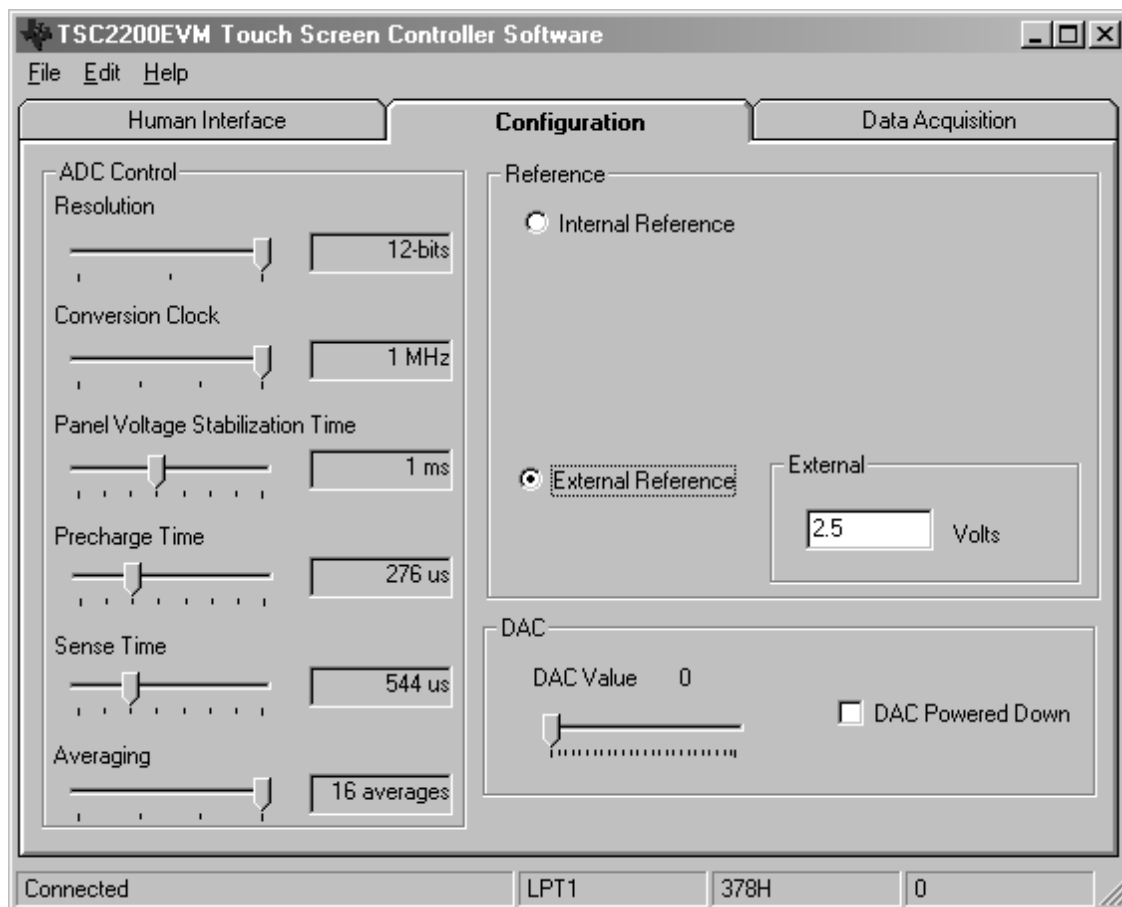

3.4.2.3 DAC Section

The DAC can be powered down by using the checkbox in this section, if it is not going to be used. If this box is not checked, the DAC value is set by using the slider in this section. Note that sliders, when selected, can change value either by moving the mouse or by using the arrow keys on the PC keyboard. Note that the DAC output voltage is dependent upon the resistor network and pull-up voltage used on the hardware. Refer to the TSC2200 data sheet for more information on the DAC operation.

3.4.3 Data Acquisition Screen

The data acquisition functions of the TSC2200 can be accessed on this screen, as shown in Figure 6.

Figure 6. Data Acquisition Screen.

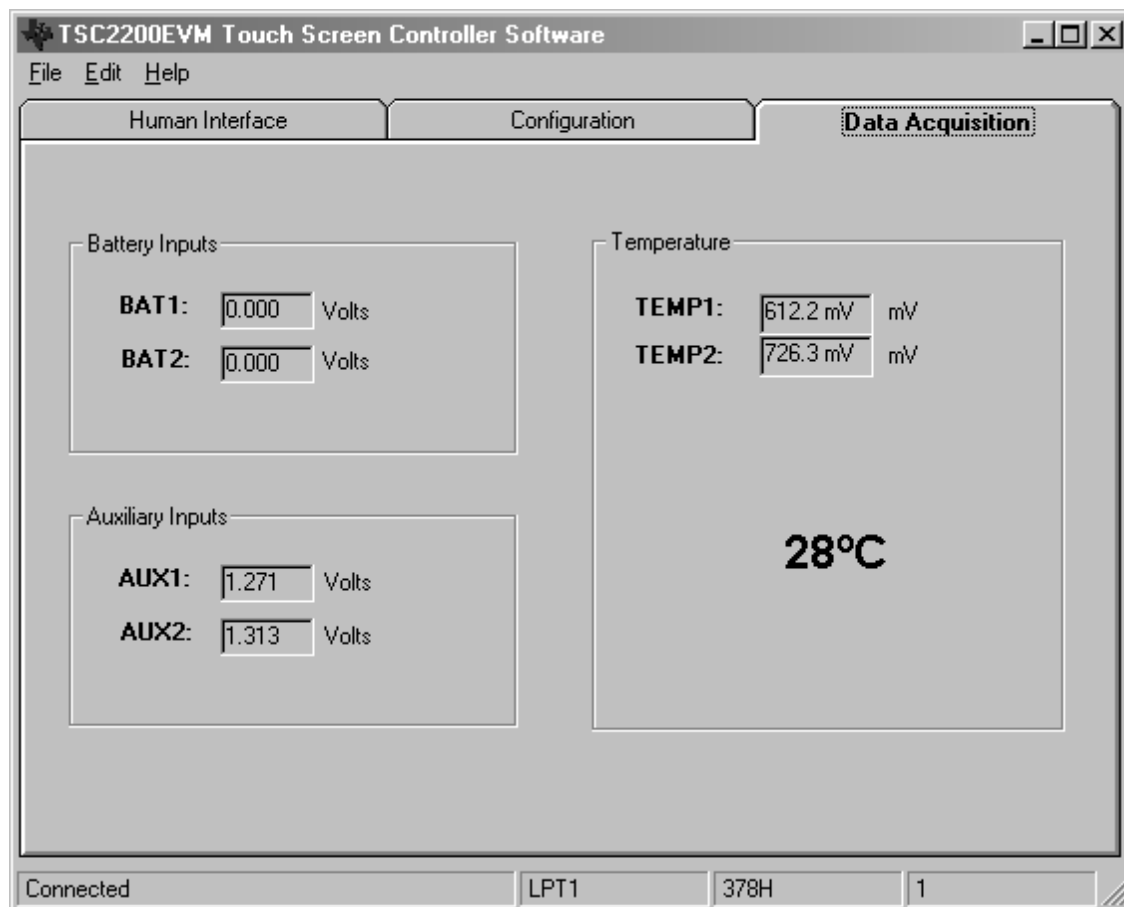

When on this screen, the TSC2200 is commanded to perform a PORT SCAN function, which updates the battery and auxiliary input voltage readings, and then is commanded to perform a TEMP1 and TEMP2 measurement. These measurements are all repeated once every second, and the results displayed on this screen.

Physical Description

This chapter has the schematics and PCB layout information in it.

Topic	Page
Schematics	4-2
Component Locations	4-4
Bill of Materials	4-6

4.1 Schematics

4.1.1 TSC100PM Motherboard

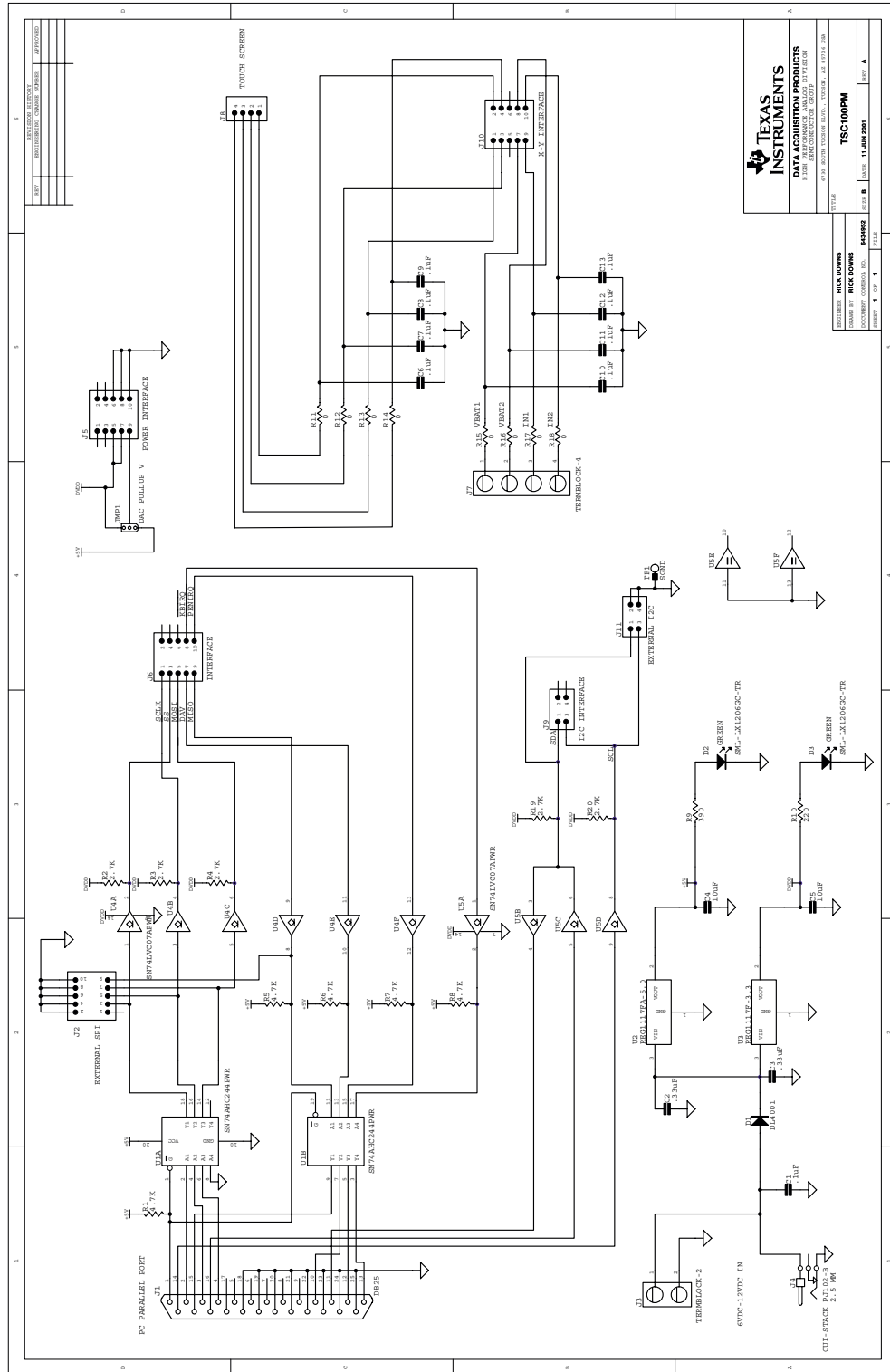

4.1.2 TSC2200EVM Daughter Card

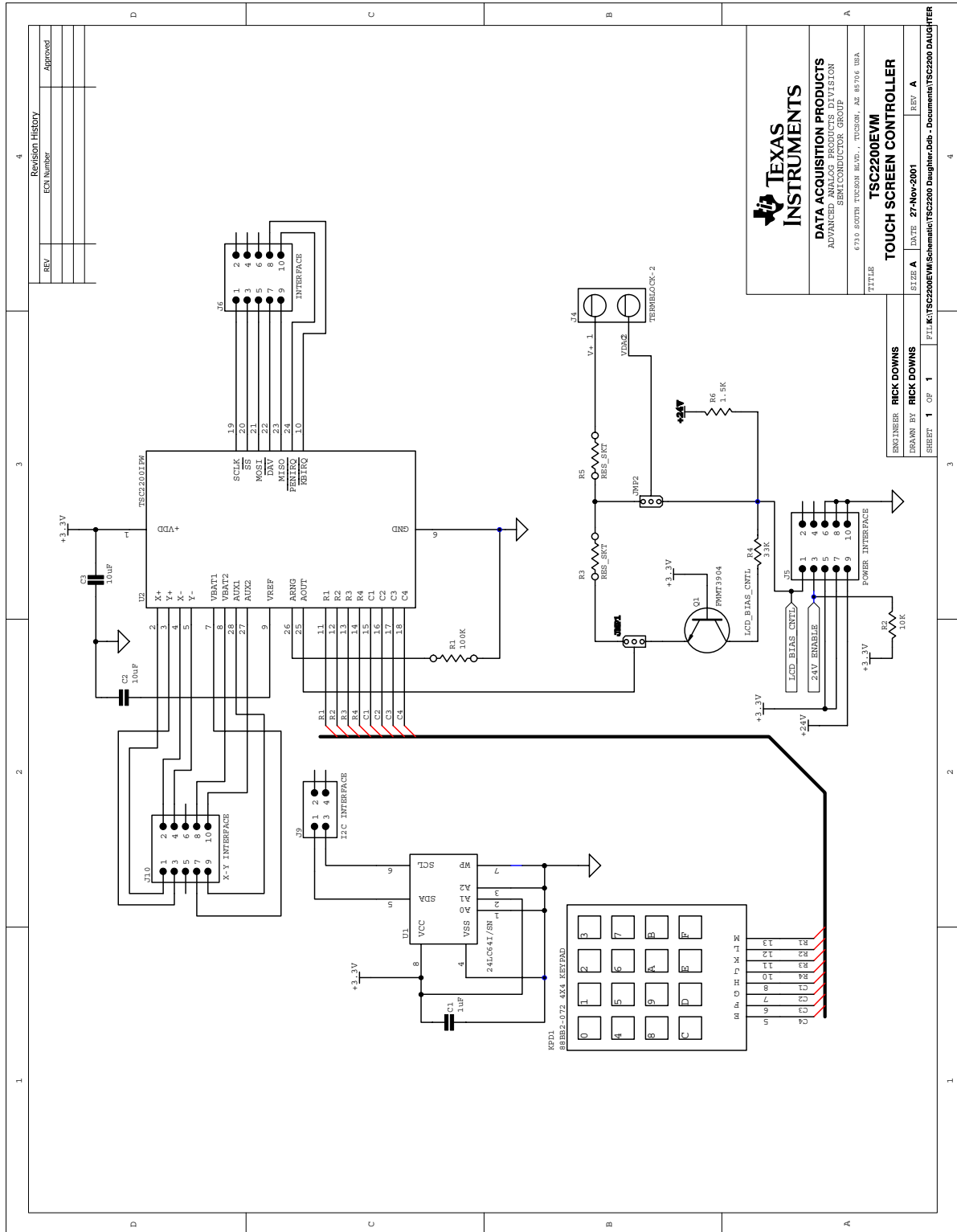

REV	ECN Number	Approved

TEXAS INSTRUMENTS
 DATA ACQUISITION PRODUCTS
 ADVANCED ANALOG PRODUCTS DIVISION
 SEMICONDUCTOR GROUP
 6730 SOUTH TUCSON BLVD., TUCSON, AZ 85706 USA

TSC2200EVM
TOUCH SCREEN CONTROLLER
 TITLE
 SIZE A DATE 27-Nov-2001 REV A
 ENGINEER RICK DOWNS
 DRAWN BY RICK DOWNS
 SHEET 1 OF 1 FILE: K:\TSC2200EVM\Schematic\TSC2200 Daughter.Ddb - Document\TSC2200 DAUGHTER

4.2 Component Locations

4.2.1 TSC100PM Motherboard

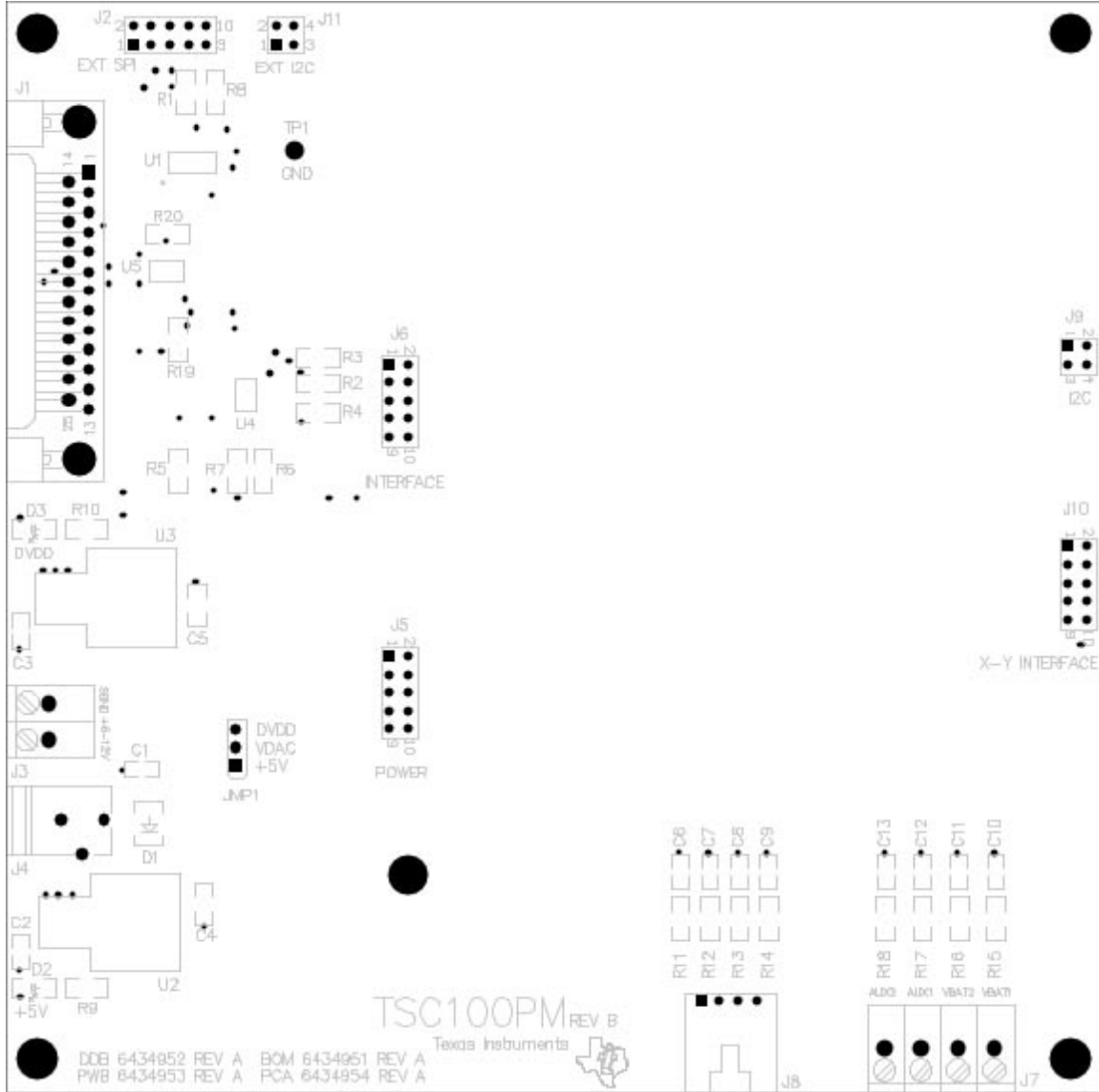

4.2.2 TSC2200EVM Daughter Card

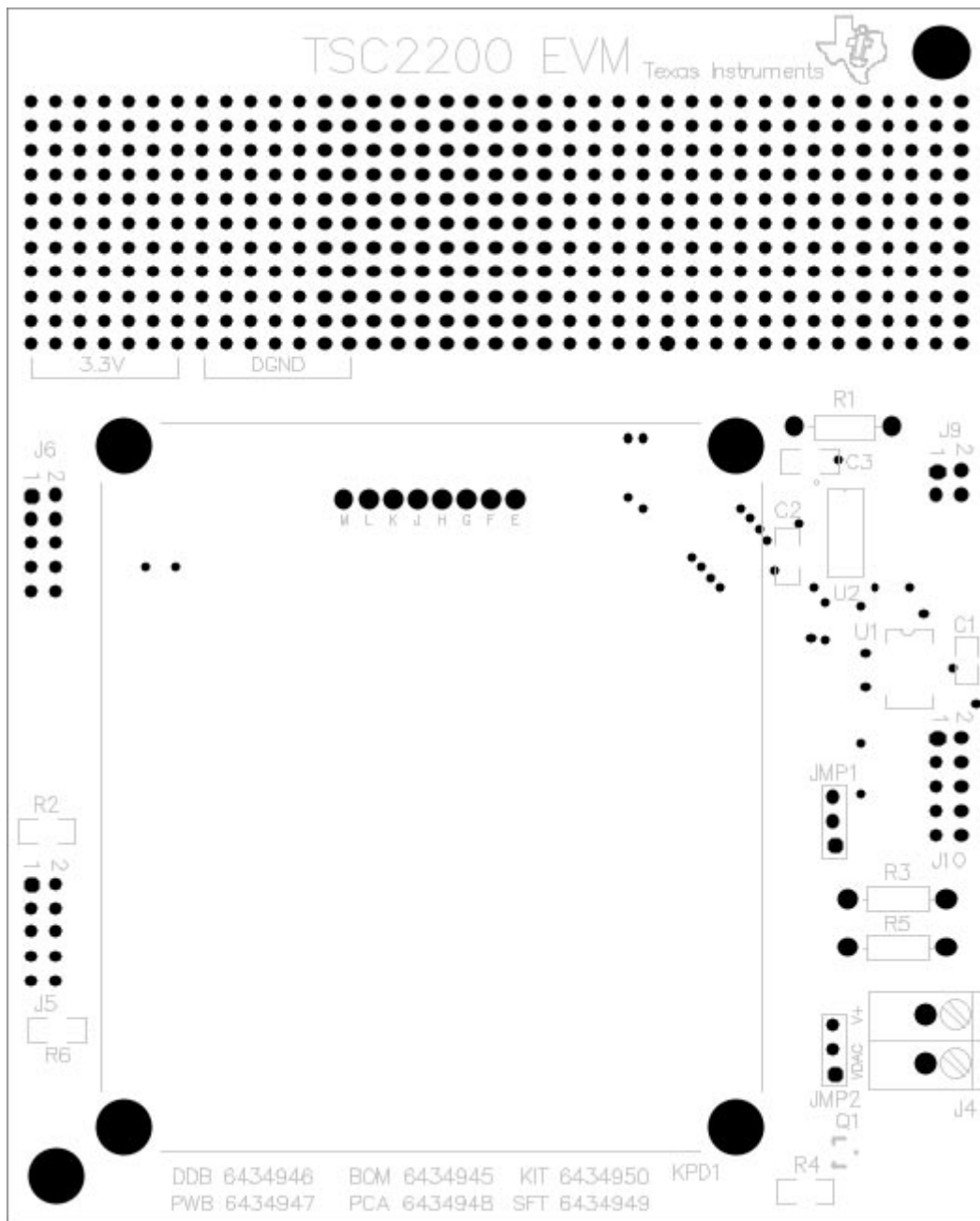

4.3 Bill of Materials

4.3.1 TSC100PM Motherboard

Item No.	Value	Reference Designators	Qty	Mfg	Mfg's Part Number	Description
1	0.1 μ F	C1	1	Panasonic or Alternate	ECJ-2VB1C104K	Cap 0.1 μ F 16V 10% Ceramic Chip 805
Not Installed	0.1 μ F	C6-C13	8	Panasonic or Alternate	ECJ-2VB1C104K	Cap 0.1 μ F 16V 10% Ceramic Chip 805
2	0.33 μ F	C2, C3	2	Panasonic or Alternate	ECJ-2YB1C334K	Cap 0.33 μ F 16V 10% Ceramic Chip 805
3	10 μ F	C4, C5	2	Panasonic or Alternate	ECJ-3YB0J106K	Cap 10 μ F 6.3V 10% Ceramic Chip 1206
4		D1	1	Micro Commercial	DL4001	Diode 1A 50V SMD MELF
5		D2, D3	2	Lumex	SML-LX1206GC-TR	LED Green Clear 1206 SMD
6		J1	1	AMP Incorporated	747842-4	DB25 Right Angle Female Conn w/Board Locks
7		J8	1	AMP Incorporated	103634-3	4-Pin Right Angle Latching Header
8		J4	1	CUI-Stack	PJ-102B	2.5mm Power Connector
9		J3	1	On Shore Technology	ED120/2DS	2 Contact Screw Terminal Block
10		J7	1	On Shore Technology	ED120/4DS	4 Contact Screw Terminal Block
11		J9	1	Samtec	SLW-102-01-S-D	4-Pin Double Row Low Profile Socket (2x2)
12		J5, J6, J10	3	Samtec	SLW-105-01-S-D	10-Pin Double Row Low Profile Socket (2x5)
13		J2	1	Samtec	TSW-105-07-L-D	10-Pin Double Row Header (5x2)
14		J11	1	Samtec	TSW-102-07-L-D	4-Pin Double Row Header (2x2)
15		JMP1	1	Samtec	TSW-103-07-L-S	3-Pin Single Row Header (3x1)
16	0	R11, R12, R13, R14, R15, R16, R17, R18	8	Panasonic or Alternate	ERJ-8GEY0R00V	RES 0 Ω 1/8W 5% 1206 SMD
17	220	R10	1	Panasonic or Alternate	ERJ-8GEYJ221V	RES 220 Ω 1/8W 5% 1206 SMD

Item No.	Value	Reference Designator	Qty	Mfg	Mfg's Part Number	Description
18	390	R9	1	Panasonic or Alternate	ERJ-8GEYJ391V	RES 390Ω 1/8W 5% 1206 SMD
19	2.7kΩ	R2, R3, R4, R19, R20	5	Panasonic or Alternate	ERJ-8GEYJ272V	RES 2.7KΩ 1/8W 5% 1206 SMD
20	4.7Ω	R1, R5, R6, R7, R8	5	Panasonic or Alternate	ERJ-8GEYJ472V	RES 4.7KΩ 1/8W 5% 1206 SMD
21		TP1	1	Keystone Electronics	5011	Multi-Purpose Test Point Loop
22		U1	1	Texas Instruments	SN74AHC244PWR	Octal Buffers/Drivers with 3-State Outputs
23		U2	1	Texas Instruments	REG1117-5.0	5V LDO Regulator DDPAK
24		U3	1	Texas Instruments	REG1117-3.3	3.3V LDO Regulator DDPAK
25		U4, U5	2	Texas Instruments	SN74LVC07APWR	Hex CMOS Open Drain Buffers
26		N/A	1	Samtec or Alternate	SNT-100-BK-TH	Shorting Jumper
27		N/A	1	Keystone Electronics or Alternate	1808	¼" x 0.625 Hex 4-40 Threaded Standoff
28		N/A	2	Keystone Electronics or Alternate	8714	¼" x 0.25 Hex 4-40 M/F Threaded Standoff
29		N/A	2	Building Fasteners or Alternate	INT LWZ 004	Number 4 Internal Tooth Lock Washer
30		N/A	2	Building Fasteners or Alternate	PMS 440 0025 PH	Pan Head Machine Screws 4-40 x ¼" Phillips
31		N/A	3	Building Fasteners or Alternate	PMS 440 0050 PH	Pan Head Machine Screws 4-40 x ½" Phillips
32		DDB		Texas Instruments	6434952	Design Database
33		PWB		Texas Instruments	6434953	Printed Wiring Board
34		PCA		Texas Instr.	6434954	Printed Circuit Assembly

4.3.2 TSC2200EVM Daughter Card

Item No.	Value	Reference Designators	Qty	Mfg	Mfg's Part Number	Description
1	1 μ F	C1	1	Panasonic or Alternate	ECJ-2YB1A105K	Cap 1 μ F 10V 10% Ceramic Chip 805
2	10 μ F	C2, C3	2	Panasonic or Alternate	ECJ-3YB0J106K	Cap 10 μ F 6.3V 10% Ceramic Chip 1206
3		J4	1	On Shore Technology	ED120/2DS	2 Contact Screw Terminal Block
4		J9	1	Samtec	TLW-102-06-G-D	4-Pin Double Row Low Profile Header (2x2)
5		J5, J6, J10	3	Samtec	TLW-105-06-G-D	10-Pin Double Row Low Profile Header (2x5)
6		JMP1, JMP2	2	Samtec	TSW-103-07-L-S	3-Pin Single Row Header (3x1)
7		KPD1	1	Grayhill	88BB2-072	4x4 Keypad
8		Q1	1	Zetex	FMMT3904	NPN Silicon Switching Transistor SOT23 SMD
9	1.5k Ω	R6	1	Panasonic or Alternate	ERJ-8GEYJ152V	RES 1.5k Ω 1/8W 5% 1206 SMD
10	10k Ω	R2	1	Panasonic or Alternate	ERJ-8GEYJ103V	RES 10k Ω 1/8W 5% 1206 SMD
11	33k Ω	R4	1	Panasonic or Alternate	ERJ-8GEYJ333V	RES 33k Ω 1/8W 5% 1206 SMD
12	100k Ω	R1	1	Yageo	MFR-25FBB-100K	RES 100k Ω 1/4W 1% Axial
13		R1, R3, R5	6	AMP Incorporated	50863-5	Miniature Spring Socket
14		U1	1	MicroChip	24LC64I/SN	64K 12C CMOS Serial EEPROM
15		U2	1	Texas Instruments	TSC2200IPW	PDA Analog Interface Circuit
16		N/A	2	Samtec or Alternate	SNT-100-BK-TH	Shorting Jumper
17		E, F, G, H, J, K, L, M	8	AMP Incorporated	50864-5	Miniature Spring Socket
18		N/A	4	Building Fasteners or Alternate	MPMS 002 0008 PH	Pan Head Machine Screws No 2x8mm Phillips

Item No.	Value	Reference Designator	Qty	Mfg	Mfg's Part Number	Description
19		N/A	4	Building Fasteners or Alternate	MLWZ 002	No 2 Metric Lock Washer
20		N/A	4	Building Fasteners or Alternate	MLWZ 002	No 2 Metric Nut
21		DDB	1	Texas Instruments	6434946	Design Database
22		PWB	1	Texas Instruments	6434947	Printed Wiring Board
23		PCA	1	Texas Instruments	6434948	Printed Circuit Assembly