

SERIES: VOF-30C | **DESCRIPTION:** AC-DC POWER SUPPLY

FEATURES

- universal input (85~264 Vac)
- 3 x 2 x 1.1 in (76.2 x 50.8 x 27 mm)
- class B EMI performance, meets CISPR32 / EN55032
- output short circuit, overcurrent & overvoltage protection
- designed to meet: IEC/EN/UL 60335 & 62368
- safety certified: IEC/EN/UL 62368

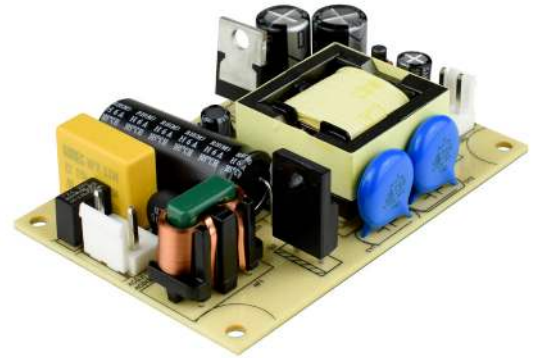

MODEL	output voltage (Vdc)	output current		output power max (W)	ripple and noise ¹ max (mVp-p)	efficiency ² typ (%)
		min (mA)	max (mA)			
VOF-30C-S3	3.3	0	4100	13.5	100	73
VOF-30C-S5	5	0	4100	20.5	100	78
VOF-30C-S9	9	0	3333	30	100	82
VOF-30C-S12	12	0	2500	30	100	84
VOF-30C-S15	15	0	2000	30	100	86
VOF-30C-S24	24	0	1250	30	100	87
VOF-30C-S48	48	0	625	30	100	88

Notes: 1. At full load, nominal input, 20 MHz bandwidth oscilloscope, with 1 μ F ceramic and 10 μ F electrolytic capacitors on the output.
 2. At 230 Vac input.
 3. All specifications are measured at Ta=25°C, humidity <75%, nominal input voltage, and rated output load unless otherwise specified.

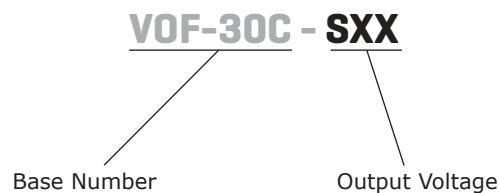
PART NUMBER KEY

INPUT

parameter	conditions/description	min	typ	max	units
voltage		85		264	Vac
		100		370	Vdc
frequency		47		60	Hz
current	at 115 Vac			750	mA
	at 230 Vac			450	mA
inrush current	at 115 Vac		20		A
	at 230 Vac		40		A
no load power consumption				0.5	W

OUTPUT

parameter	conditions/description	min	typ	max	units
capacitive load	3.3 Vdc output models			24,000	μF
	5 Vdc output models			12,000	
	9 Vdc output models			5,600	
	12 Vdc output models			5,400	
	15 Vdc output models			2,400	
	24 Vdc output models			1,440	
	48 Vdc output models			600	
initial set point accuracy	3.3 Vdc output models		±3		%
	all other models		±2		%
line regulation	at full load		±0.5		%
load regulation	from 0~100% load		±1		%
hold-up time	at 115 Vac, full load		10		ms
	at 230 Vac, full load		60		ms
switching frequency			60		kHz
temperature coefficient			±0.02		%/°C

PROTECTIONS

parameter	conditions/description	min	typ	max	units
over voltage protection	output voltage clamp, auto recovery				Vdc
	3.3, 5 Vdc output models			7.5	
	9 Vdc output models			15	
	12, 15 Vdc output models			20	
	24 Vdc output models			30	
	48 Vdc output models			60	
over current protection	hiccup, auto recovery	110		300	%
short circuit protection	hiccup, continuous, auto-recovery				

SAFETY & COMPLIANCE

parameter	conditions/description	min	typ	max	units
isolation voltage	input to output electric strength test for 1 minute, leakage current <5 mA	3,000			Vac
safety approvals	IEC/EN/UL 62368-1 certified (designed to meet IEC/EN/UL 60335-1)				
safety class	Class II				
conducted emissions	CISPR32/EN55032, Class B				
radiated emissions	CISPR32/EN55032, Class B				
ESD	IEC/EN61000-4-2, Contact ±6KV, Perf. Criteria B				
radiated immunity	IEC/EN61000-4-3 10V/m perf. Criteria A				

SAFETY & COMPLIANCE (CONTINUED)

parameter	conditions/description	min	typ	max	units
EFT/burst	IEC/EN61000-4-4, ±2 kV, perf. Criteria B				
surge	IEC/EN61000-4-5, line to line ±1KV, perf. Criteria B				
conducted immunity	IEC/EN61000-4-6, 10 Vrms, Perf. Criteria A				
voltage dips & interruptions	IEC/EN61000-4-11 , 0%,70%, perf. Criteria B				
MTBF	as per MIL-HDBK-217F at 25°C	300,000			hours
RoHS	yes				

Notes: 4. The power supply is considered a component which will be installed into final equipment. The final equipment still must be tested to meet the necessary EMC directives.

ENVIRONMENTAL

parameter	conditions/description	min	typ	max	units
operating temperature	see derating curves	-25		70	°C
storage temperature		-25		85	°C
storage humidity	non-condensing			90	%

DERATING CURVES

TEMPERATURE DERATING CURVE

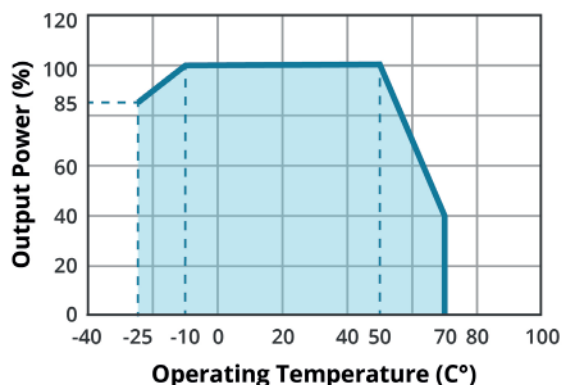

INPUT VOLTAGE DERATING CURVE (25°C)

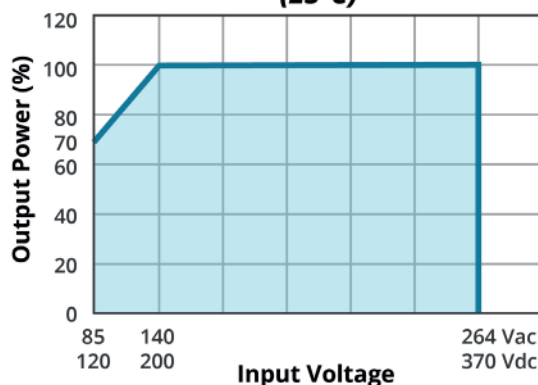

EFFICIENCY CURVES

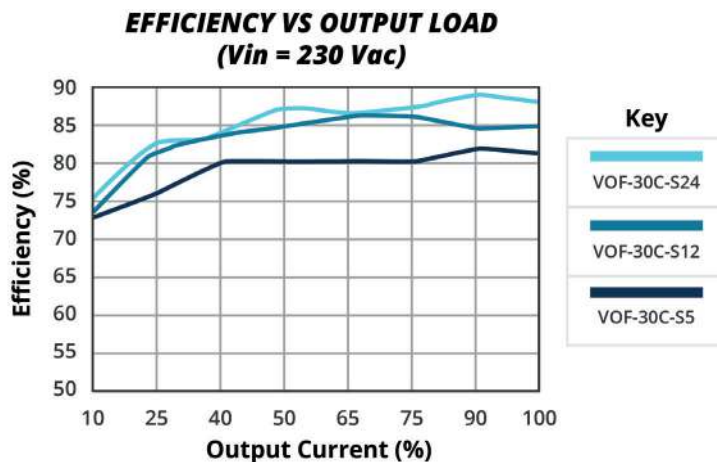
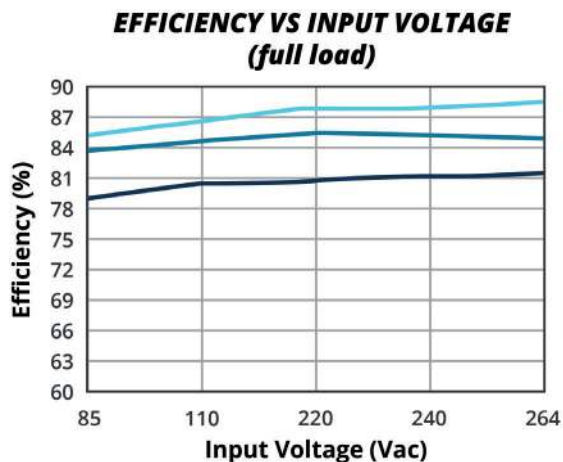

DESIGN REFERENCE

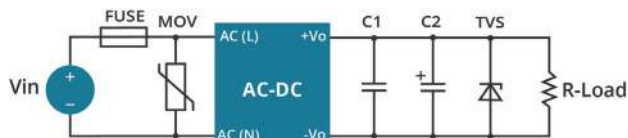

Fig. 1: Typical circuit diagram

Part No.	FUSE	MOV	C1 (μF)	C2 (μF)	TVS
VOF-30C-S3	2A/250V slow-blow	S14K300	0.1	22	SMBJ7.0A
VOF-30C-S5					SMBJ7.0A
VOF-30C-S9					SMBJ12A
VOF-30C-S12					SMBJ20A
VOF-30C-S15					SMBJ20A
VOF-30C-S24					SMBJ30A
VOF-30C-S48					SMBJ64A

Output Filter Components:

We recommend using an electrolytic capacitor with high frequency, and low ESR rating for C2 (refer to manufacture's datasheet). Choose a Capacitor voltage rating with at least 20% margin, in other words not exceeding 80%. C1 is a ceramic capacitor used for filtering high-frequency noise and TVS is a recommended suppressor diode to protect the application in case of a converter failure.

MECHANICAL

parameter	conditions/description	min	typ	max	units
dimensions	76.2 x 50.8 x 27				mm
weight			62		g

MECHANICAL DRAWING (BOARD MOUNT)

units: mm[inch]

tolerance: ±0.50[±0.020]

In CON1 model: VH-3A, Recommended terminal: VH-3Y

Out CON2 model: VH-2A, recommended terminal: VH-2Y

Mounting hole screwing torque: Max 0.4 N·m

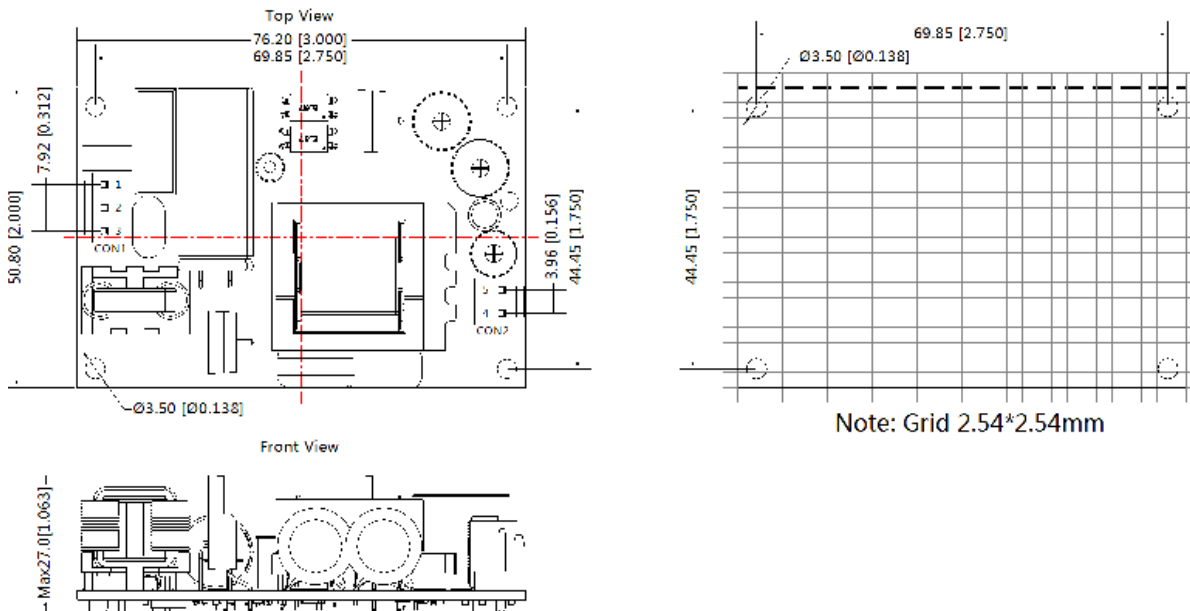

PIN-Out			
PIN	Function	Connector	Terminal
1	AC(L)	VH-3A or B2P3-VH or the same Spec.	VH-3Y or VHR-3N or the same Spec.
2	NoPin		
3	AC(N)		
4	-Vo	VH-2A or B2P-VH or the same Spec.	VH-2Y or VHR-2N or the same Spec.
5	+Vo		

REVISION HISTORY

rev.	description	date
1.0	initial release	10/24/2019
1.01	company logo updated	11/30/2020
1.02	derating and efficiency curves and circuit diagram updated	02/10/2022
1.03	UKCA mark added	06/06/2022

The revision history provided is for informational purposes only and is believed to be accurate.



CUI INC

a bel group

Headquarters
20050 SW 112th Ave.
Tualatin, OR 97062
800.275.4899

Fax 503.612.2383
cui.com
techsupport@cui.com

CUI offers a two (2) year limited warranty. Complete warranty information is listed on our website.

CUI reserves the right to make changes to the product at any time without notice. Information provided by CUI is believed to be accurate and reliable. However, no responsibility is assumed by CUI for its use, nor for any infringements of patents or other rights of third parties which may result from its use.

CUI products are not authorized or warranted for use as critical components in equipment that requires an extremely high level of reliability. A critical component is any component of a life support device or system whose failure to perform can be reasonably expected to cause the failure of the life support device or system, or to affect its safety or effectiveness.