

6

5

4

3

2

1

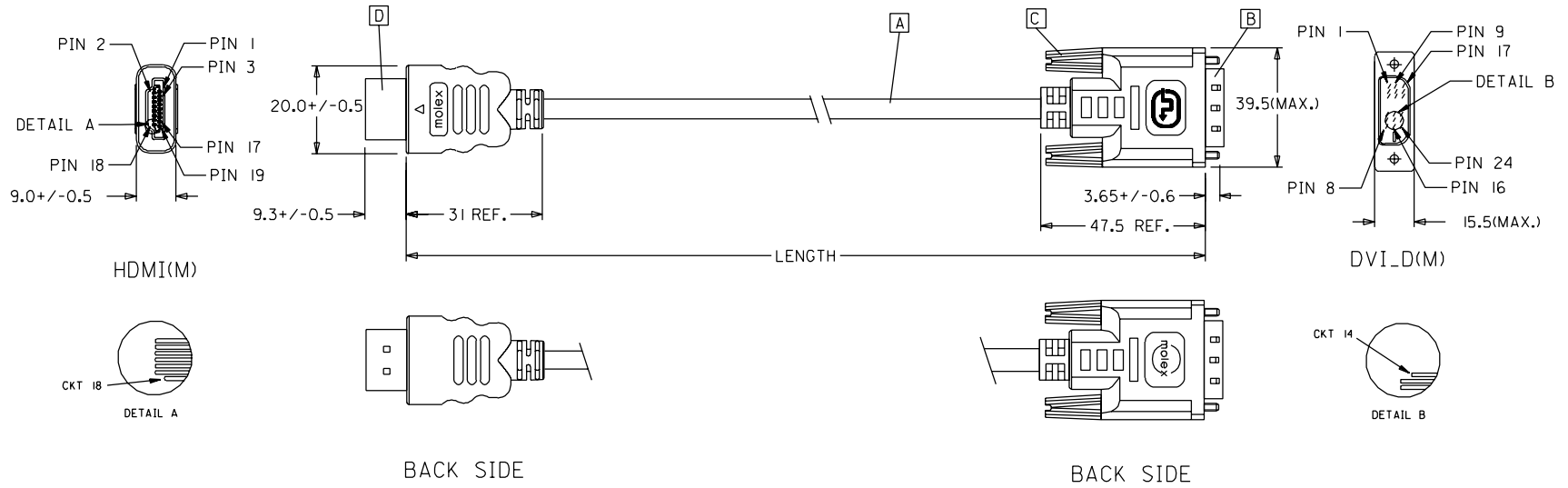

88768-3620	HDMI TO DVI-D(M) CABLE ASS'Y,3M	3000+/-80	BLACK	5,5MM(TMDS - AWG*30)
88768-3610	HDMI TO DVI-D(M) CABLE ASS'Y,2M	2000+/-60	BLACK	5,5MM(TMDS - AWG*30)
88768-3600	HDMI TO DVI-D(M) CABLE ASS'Y,1M	1000+/-30	BLACK	5,5MM(TMDS - AWG*30)
88768-3530	HDMI TO DVI-D(M) CABLE ASS'Y,5M	5000+/-100	BLACK	7,3MM(TMDS - AWG*28)
88768-3520	HDMI TO DVI-D(M) CABLE ASS'Y,3M	3000+/-80	BLACK	7,3MM(TMDS - AWG*28)
88768-3510	HDMI TO DVI-D(M) CABLE ASS'Y,2M	2000+/-60	BLACK	7,3MM(TMDS - AWG*28)
88768-3500	HDMI TO DVI-D(M) CABLE ASS'Y,1M	1000+/-30	BLACK	7,3MM(TMDS - AWG*28)
MX P/N	DESCRIPTION	LENGTH	CABLE COLOR	CABLE OD

EC NO. DRWN: CHK: APPR: C	DESCRIPTION REV	QUALITY SYMBOLS MAJOR ▼ = 0 CRITICAL ▽ = 0	GENERAL TOLERANCES: (UNLESS SPECIFIED)		SCALE N.S.T	DESIGN UNITS <input checked="" type="checkbox"/> mm <input type="checkbox"/> INCH	<input type="checkbox"/> THIRD ANGLE <input type="checkbox"/> mm <input type="checkbox"/> INCH <input checked="" type="checkbox"/> mm ONLY	SHT REV
		4 PLACES ±0. ±. 3 PLACES ±0. ±. 2 PLACES ±0. ±. 1 PLACE ±0. ±.	mm INCH ±. ±. ±. ±. ±. ±. ±. ±.	DRAWN BY & DATE Louis Chen 03/11/17	TITLE: HDMI(M) TO DVI-D(M) CABLE ASS'Y			REVISION ON CAD ONLY
		ANGULAR: ± °	APPROVED BY & DATE Baron Chen 03/11/17	MOLEX INCORPORATED			SHEET NO. 1 OF 2	
		CAD FILENAME S88768AA.SOI	MATERIAL NO. SEE TABLE	DRAWING NO. SD-88768-001	THIS DRAWING CONTAINS INFORMATION THAT IS PROPRIETARY TO MOLEX INCORPORATED AND SHOULD NOT BE USED WITHOUT WRITTEN PERMISSION.			

E

D

C

B

A

6

5

4

3

2

1

NOTE: 1. OVERMOLD SPECIFICATION

1.1 DVI BOOT MOLDED WITH SNOW WHITE PVC RESIN P/N.

1.1.1 UL94V-0

1.1.2 HARDNESS (DUROMETER): SHORE A 90-95

1.2 HDMI OUTER MOLD WITH BLACK PVC RESIN. UL94V-0.

2. MECHANICAL SPECIFICATION

2.1 CABLE SHOULD STAND THE PULL FORCE 89-111N FOR 30 SECONDS WITH NO VISIBLE TERMINATION DAMAGE.

2.2 CABLE SHOULD PASS THE FLEX TEST IN 100 CYCLES AT EACH OF PLANES, PER EIA 364-41, CONDITION 1.

3. CABLE ELECTRICAL SPECIFICATION

3.1 DIELECTRIC STRENGTH: 300V AC FOR 10MS.

3.2 INSULATION RESISTANCE: 10 MEGA Ohms MIN.

3.3 DIFFERENTIAL LINES CHARACTERISTIC IMPEDANCE: 100+/-10 Ohms @TDR.

3.4 CONTACT RESISTANCE: 2 OHMS(MAX.).

3.5 SIGNALS CROSSTALK(FEXT): 5% (MAX.) PER ANSI/EIA-364-90.







3.6 SIGNALS INTRA-PAIR SKEW : <150 ps.

4. DVI CONNECTOR SPECIFICATION

4.1 REFER TO PRODUCT SPEC. PS74320-0001.

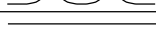
4.2 CONTACT PLATING: AU FLASH.

5. MATERIAL MUST MEET MANAGEMENT REGULATIONS FOR ENVIRONMENT (MX TS-0002).

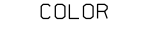
SHIELD	SHIELD		GROUND
PIN 19	PIN 16	=====	HOT PLUG DETECT
PIN 18	PIN 14	=====	POWER +5V
PIN 17	PIN 15	=====	GROUND(+5V&DDC)
PIN 16	PIN 7	=====	DDC DATA(SDA)
PIN 15	PIN 6	=====	DDC CLOCK(SCL)
PIN 11	PIN 22	=====	TMDS CLOCK SHIELD
PIN 12	PIN 24		TMDS CLOCK-
PIN 10	PIN 23		TMDS CLOCK+
PIN 8	PIN 19	=====	TMDS DATA 0 SHIELD
PIN 9	PIN 17		TMDS DATA 0-
PIN 7	PIN 18		TMDS DATA 0+
PIN 5	PIN 11	=====	TMDS DATA 1 SHIELD
PIN 6	PIN 9		TMDS DATA 1-
PIN 4	PIN 10		TMDS DATA 1+
PIN 2	PIN 3	=====	TMDS DATA 2 SHIELD
PIN 3	PIN 1		TMDS DATA 2-
PIN 1	PIN 2		TMDS DATA 2+
HDMI	DVI-D	COLOR	CABLE FUNCTION

ITEM	DESCRIPTION	QTY.
D	HDMI PLUG ASSY'	1
C	DVI THUMB SCREW	2
B	DVI_D SINGLE CHANNEL G/F CONNECTOR	1
A	DVI SINGLE LINK CABLE (SEE TABLE)	1

EC NO. DRWN: CHK: APPR: C	DESCRIPTION REV	QUALITY SYMBOLS MAJOR ▼ = 0 CRITICAL ▽ = 5	GENERAL TOLERANCES: (UNLESS SPECIFIED) <table border="1"> <thead> <tr> <th></th> <th>mm</th> <th>INCH</th> </tr> </thead> <tbody> <tr> <td>4 PLACES</td> <td>±0.</td> <td>±.</td> </tr> <tr> <td>3 PLACES</td> <td>±0.</td> <td>±.</td> </tr> <tr> <td>2 PLACES</td> <td>±0.</td> <td>±.</td> </tr> <tr> <td>1 PLACE</td> <td>±0.</td> <td>±.</td> </tr> </tbody> </table>		mm	INCH	4 PLACES	±0.	±.	3 PLACES	±0.	±.	2 PLACES	±0.	±.	1 PLACE	±0.	±.	SCALE N.S.T DESIGN UNITS <input checked="" type="checkbox"/> mm <input type="checkbox"/> INCH THIRD ANGLE PROJECTION <input type="checkbox"/> mm INCH <input type="checkbox"/> INCH mm <input checked="" type="checkbox"/> mm ONLY	DRAWN BY & DATE Louis Chen 03/11/17 CHECKED BY & DATE Teddy Kan 03/11/17 APPROVED BY & DATE Boron Chen 03/11/17	TITLE: HDMI(M) TO DVI-D(M) CABLE ASS'Y MOLEX INCORPORATED	SHT REV
			mm	INCH																		
		4 PLACES	±0.	±.																		
		3 PLACES	±0.	±.																		
2 PLACES	±0.	±.																				
1 PLACE	±0.	±.																				
CAD FILENAME S88768AA.S02	MATERIAL NO. SEE TABLE	DRAWING NO. SD-88768-001	SHEET NO. 2 OF 2																			
THIS DRAWING CONTAINS INFORMATION THAT IS PROPRIETARY TO MOLEX INCORPORATED AND SHOULD NOT BE USED WITHOUT WRITTEN PERMISSION.				SIZE A4																		

7 6 5 4 3 2 1

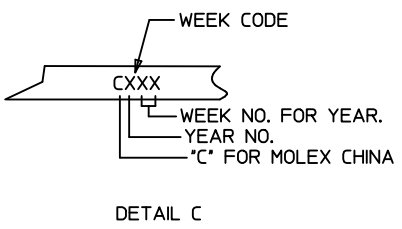
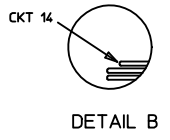
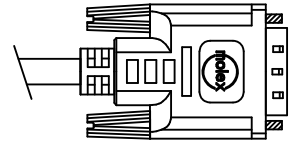
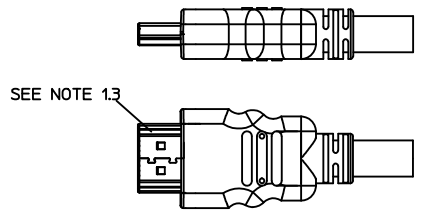
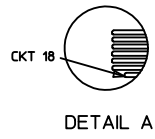
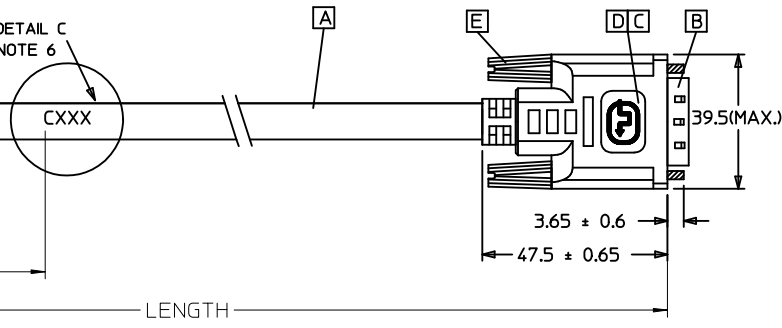
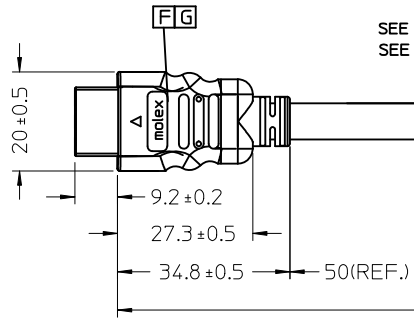
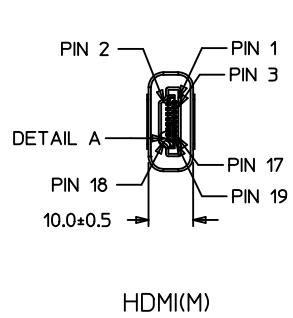

MX P/N	DESCRIPTION	LENGTH	CABLE COLOR	CABLE OD	CABLE P/N
887683630	HDMI TO DVI-D(M) CABLE ASS'Y,5M	5000 ± 100	BLACK	5.5MM(TMS - AWG#30)	887808273
887683620	HDMI TO DVI-D(M) CABLE ASS'Y,3M	3000 ± 80	BLACK	5.5MM(TMS - AWG#30)	887808273
887683610	HDMI TO DVI-D(M) CABLE ASS'Y,2M	2000 ± 60	BLACK	5.5MM(TMS - AWG#30)	887808273
887683600	HDMI TO DVI-D(M) CABLE ASS'Y,1M	1000 ± 30	BLACK	5.5MM(TMS - AWG#30)	887808273

ENTER DESCRIPTION EC NO: DG2011-0441 DRWN:FZHANG01 CHKD:JLJ113 APPR:ZXDENG	2011/05/04 2011/05/04 2011/05/11	DESCRIPTION REV	QUALITY SYMBOLS ▽=0 ◻=0	GENERAL TOLERANCES (UNLESS SPECIFIED)		DIMENSION STYLE MM ONLY		SCALE ---	DESIGN UNITS METRIC	THIRD ANGLE PROJECTION	
					mm	INCH	DRAWN BY	DATE	TITLE HDMI(M) TO DVI-D(M) CABLE ASS'Y		
				4 PLACES	± ---	± ---	FZHANG01	2011/05/04			
				3 PLACES	± ---	± ---	CHECKED BY	DATE	MOLEX INCORPORATED		
				2 PLACES	± ---	± ---	YHXU	2011/05/04			
1 PLACE	± ---	± ---	APPROVED BY	DATE	DOCUMENT NO. SD-88768-36XX						
ANGULAR ± ---°		DRAFT WHERE APPLICABLE MUST REMAIN WITHIN DIMENSIONS		MATERIAL NO. 8876836xx			SHEET NO. 1 OF 2				
THIS DRAWING CONTAINS INFORMATION THAT IS PROPRIETARY TO MOLEX INCORPORATED AND SHOULD NOT BE USED WITHOUT WRITTEN PERMISSION											

6 5 4 3 2 1

NOTE:

1. OVERMOLD SPECIFICATION:
 - 1.1 DVI BOOT MOLDED SNOW WHITE PVC RESIN UL94V-0.
 - 1.2 HDMI INNER MOLDED WITH PVC RESIN
HDMI OUTER MOLDED WITH PVC RESIN
 - 1.3 DUST COVER MOLDED WITH PE
2. THE CODE PLEASE BE PRINTED ON THE SPACE
3. PRODUCT ELECTRICAL SPECIFICATION:
 - 3.1 HI-POT VOLTAGE: 300V DC FOR 10mS
 - 3.2 INSULATION RESISTANCE: 10 MEGA Ohms MIN.
 - 3.3 CONTACT RESISTANCE: 2 OHMS MAX. FOR 1&2&3M; 3 OHMS MAX. FOR 5M.
 - 3.4 DIFFERENTIAL LINES CHARACTERISTIC IMPEDANCE) : 100± 10 Ohms @TDR.
 - 3.5 SIGNALS CROSSTALK (FEET) : 5% (MAX.) PER ANSI/EIA-364-90.
 - 3.6 SIGNALS INTRA-PAIR SKEW(PER CABLE): <150PS.
4. DVI CONNECTOR SPECIFICATION:
 - 4.1 REFER TO PRODUCT SPEC. PS74320-001
 - 4.2 CONTACT PLATING: AU FLASH.
5. THIS PRODUCT MUST MEET EU CHEMICAL SUBSTANCE SPECIFICATION FOR PRODUCTS. (EU 2002/95/EC)

SHIELD	SHIELD	OVERALL SHIELD	GROUND
PIN 19	PIN 16	WHITE	HOT PLUG DETECT
PIN 18	PIN 14	YELLOW	POWER +5V
PIN 17	PIN 15	ORANGE	GROUND(+5V&DDC)
PIN 16	PIN 7	RED	DDC DATA(SDA)
PIN 15	PIN 6	VIOLET	DDC CLOCK(SCL)
PIN 12	PIN 24	WHITE	TMDS CLOCK-
PIN 11	PIN 22	BRAID	TMDS CLOCK SHIELD
PIN 10	PIN 23	BROWN	TMDS CLOCK+
PIN 9	PIN 17	WHITE	TMDS DATA 0-
PIN 8	PIN 19	BRAID	TMDS DATA 0 SHIELD
PIN 7	PIN 18	BLUE	TMDS DATA 0+
PIN 6	PIN 9	WHITE	TMDS DATA 1-
PIN 5	PIN 11	BRAID	TMDS DATA 1 SHIELD
PIN 4	PIN 10	GREEN	TMDS DATA 1+
PIN 3	PIN 1	WHITE	TMDS DATA 2-
PIN 2	PIN 3	BRAID	TMDS DATA 2 SHIELD
PIN 1	PIN 2	RED	TMDS DATA 2+
HDMI	DVI-D	COLOR	CABLE FUNCTION

ITEM	DESCRIPTION	QTY.
G	Metal Shell For HDMI 19P Male	1
F	HDMI 19P MALE,30U"Au Solder Type	1
E	DVI THUMB SCREW	2
D	PCB	1
C	ONE BODY CAN	1
B	DVI_D SINGLE CHANNEL G/F CONNECTOR	1
A	DVI SINGLE LINK CABLE (SEE TABLE)	1

ENTER DESCRIPTION EC NO: DG2011-0441 DRWN:FZHANG01 CHKD:JLILU13 APPR:ZXDENG	2011/05/04 2011/05/04 2011/05/11	DESCRIPTION REV	QUALITY SYMBOLS ▽=0 ◻=0	GENERAL TOLERANCES (UNLESS SPECIFIED)		DIMENSION STYLE MM ONLY		SCALE ---	DESIGN UNITS METRIC	THIRD ANGLE PROJECTION		
					mm	INCH	DRAWN BY FZHANG01	DATE 2011/05/04	TITLE HDMI(M) TO DVI-D(M) CABLE ASS'Y			
				4 PLACES	± ---	± ---	CHECKED BY YHXU	DATE 2011/05/04				
				3 PLACES	± ---	± ---	APPROVED BY ZXDENG	DATE 2011/05/11	MATERIAL NO. 8876836xx		DOCUMENT NO. SD-88768-36XX	SHEET NO. 2 OF 2

DRAFT WHERE APPLICABLE MUST REMAIN WITHIN DIMENSIONS

SIZE
A 4

THIS DRAWING CONTAINS INFORMATION THAT IS PROPRIETARY TO MOLEX INCORPORATED AND SHOULD NOT BE USED WITHOUT WRITTEN PERMISSION

7 6 5 4 3 2 1

E
D
C
B
A

E
D
C
B
A

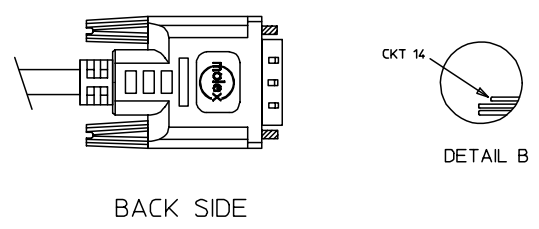
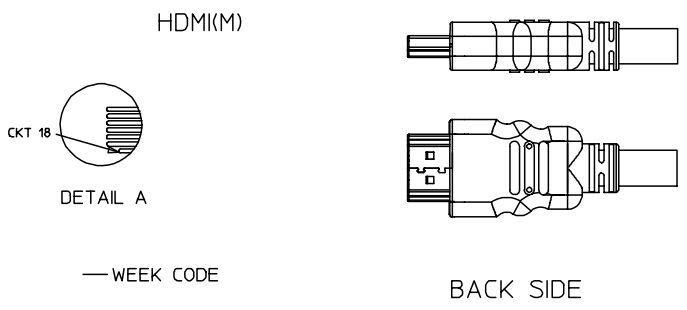
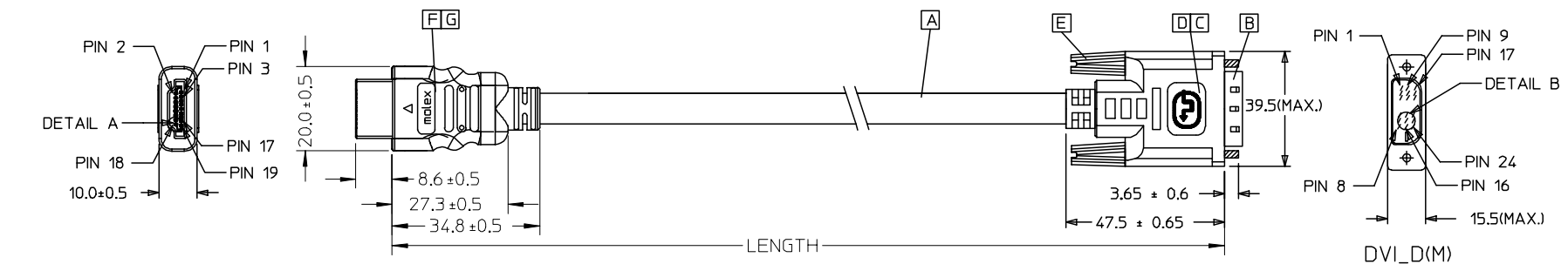

88768-3630	HDMI TO DVI-DIM) CABLE ASS'Y,5M	5000 ± 100	BLACK	5.5MM(TMDS - AWG#30)	887808273
88768-3620	HDMI TO DVI-DIM) CABLE ASS'Y,3M	3000 ± 80	BLACK	5.5MM(TMDS - AWG#30)	887808273
88768-3610	HDMI TO DVI-DIM) CABLE ASS'Y,2M	2000 ± 60	BLACK	5.5MM(TMDS - AWG#30)	887808273
88768-3600	HDMI TO DVI-DIM) CABLE ASS'Y,1M	1000 ± 30	BLACK	5.5MM(TMDS - AWG#30)	887808273
MX P/N	DESCRIPTION	LENGTH	CABLE COLOR	CABLE OD	CABLE P/N

ENTER DESCRIPTION EC NO: DG2005-0094 DRWN: JLIU13 2005/01/18 CHKD: TEDDY 2005/01/18 APPR: TKAN 2005/01/20	QUALITY SYMBOLS ▽=0 ◻=0	GENERAL TOLERANCES (UNLESS SPECIFIED)		DIMENSION STYLE		SCALE	DESIGN UNITS	THIRD ANGLE PROJECTION	
			mm	INCH	MM ONLY		---		METRIC
		4 PLACES	±---	±---	DRAWN BY	DATE	TITLE		
		3 PLACES	±---	±---	JLIU13	2005/01/18	#30 HDMI TO DVI 2M CABLE ASS'Y		
			2 PLACES	±---	±---	CHECKED BY	DATE		
			1 PLACE	±---	±---	TEDDY	2005/01/18		
			ANGULAR ±---°		APPROVED BY		DATE		
			DRAFT WHERE APPLICABLE MUST REMAIN WITHIN DIMENSIONS		BORON		2005/01/18		
					MATERIAL NO.	DOCUMENT NO.		SHEET NO.	
					887683610	SD887683610		1 OF 2	
					SIZE	THIS DRAWING CONTAINS INFORMATION THAT IS PROPRIETARY TO MOLEX INCORPORATED AND SHOULD NOT BE USED WITHOUT WRITTEN PERMISSION			
					A/4				

6 5 4 3 2 1

7 6 5 4 3 2 1

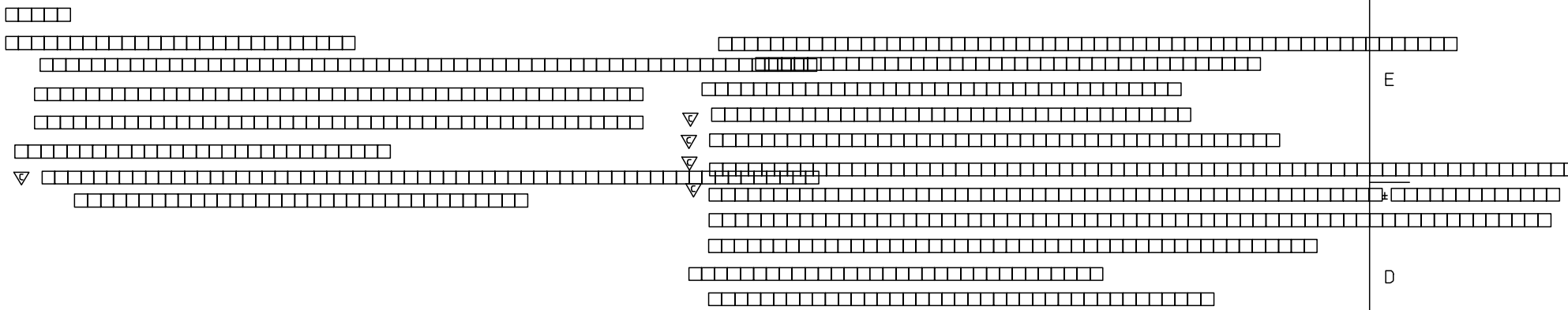

SHIELD	SHIELD	OVERALL SHIELD	GROUND
PIN 19	PIN 16	WHITE	HOT PLUG DETECT
PIN 18	PIN 14	YELLOW	POWER +5V
PIN 17	PIN 15	ORANGE	GROUND(+5V&DDC)
PIN 16	PIN 7	RED	DDC DATA(SDA)
PIN 15	PIN 6	VIOLET	DDC CLOCK(SCL)
PIN 12	PIN 24	WHITE	TMDS CLOCK-
PIN 11	PIN 22	BRAID	TMDS CLOCK SHIELD
PIN 10	PIN 23	BROWN	TMDS CLOCK+
PIN 9	PIN 17	WHITE	TMDS DATA 0-
PIN 8	PIN 19	BRAID	TMDS DATA 0 SHIELD
PIN 7	PIN 18	BLUE	TMDS DATA 0+
PIN 6	PIN 9	WHITE	TMDS DATA 1-
PIN 5	PIN 11	BRAID	TMDS DATA 1 SHIELD
PIN 4	PIN 10	GREEN	TMDS DATA 1+
PIN 3	PIN 1	WHITE	TMDS DATA 2-
PIN 2	PIN 3	BRAID	TMDS DATA 2 SHIELD
PIN 1	PIN 2	RED	TMDS DATA 2+
HDMI	DVI-D	COLOR	CABLE FUNCTION

G	HDMI METAL CAN 5011840018	1
F	HDMI HOUSING ASSY' 5011850001	1
E	DVI THUMB SCREW 887806077	2
D	PCB 887899569/887899570	1
C	ONE BODY CAN 887899396	1
B	DVI-D SINGLE CHANNEL G/F CONNECTOR 743230001	1
A	DVI SINGLE LINK CABLE (SEE TABLE)	1
ITEM	DESCRIPTION	QTY.

ENTER DESCRIPTION EC NO: DG2005-0094 DRWN: JLIU13 CH'KD: TEDDY APPR: TKAN	2005/01/18 2005/01/18 2005/01/20	DESCRIPTION REV	QUALITY SYMBOLS ▽=0 ▽=5	GENERAL TOLERANCES (UNLESS SPECIFIED) <table border="1"> <thead> <tr> <th></th> <th>mm</th> <th>INCH</th> </tr> </thead> <tbody> <tr> <td>4 PLACES</td> <td>±---</td> <td>±---</td> </tr> <tr> <td>3 PLACES</td> <td>±---</td> <td>±---</td> </tr> <tr> <td>2 PLACES</td> <td>±---</td> <td>±---</td> </tr> <tr> <td>1 PLACE</td> <td>±---</td> <td>±---</td> </tr> </tbody> </table> ANGULAR ±---°		mm	INCH	4 PLACES	±---	±---	3 PLACES	±---	±---	2 PLACES	±---	±---	1 PLACE	±---	±---	DIMENSION STYLE MM ONLY	SCALE ---	DESIGN UNITS METRIC	THIRD ANGLE PROJECTION
				mm	INCH																		
			4 PLACES	±---	±---																		
			3 PLACES	±---	±---																		
2 PLACES	±---	±---																					
1 PLACE	±---	±---																					
DRAWN BY JLIU13		DATE 2005/01/18		TITLE #30 HDMI TO DVI 2M CABLE ASS'Y																			
CHECKED BY TEDDY		DATE 2005/01/18		APPROVED BY BORON																			
APPROVED BY BORON		DATE 2005/01/18		MATERIAL NO. 887683610		DOCUMENT NO. SD887683610		SHEET NO. 2 OF 2															

DRAFT WHERE APPLICABLE
MUST REMAIN
WITHIN DIMENSIONS



THIS DRAWING CONTAINS INFORMATION THAT IS PROPRIETARY TO MOLEX INCORPORATED AND SHOULD NOT BE USED WITHOUT WRITTEN PERMISSION

6 5 4 3 2 1