

PTWE 6-2/10 - Test terminal strip



3069833

<https://www.phoenixcontact.com/us/products/3069833>

Please be informed that the data shown in this PDF document is generated from our online catalog. Please find the complete data in the user documentation. Our general terms of use for downloads are valid.



Test terminal strip, nom. voltage: 400 V, number of connections: 20, number of positions: 10, connection method: Push-in connection, 1 level, Rated cross section: 6 mm², cross section: 0.5 mm² - 10 mm², mounting type: Wall mounting, color: gray

Your advantages

- Space saving, thanks to compact, modular test terminal strips
- Cost-effective, thanks to the tailored, modular design and use of standardized CLIPLINE complete accessories
- The integrated, robust switch contact is designed for the most stringent demands, and the use of high-quality materials ensures the transmission of signal currents, even after multiple actuations
- Maximum safety with leading and automatic transformer short circuit

Commercial data

Item number	3069833
Packing unit	1 pc
Minimum order quantity	1 pc
Note	Made to order (non-returnable)
Sales key	BE06
Product key	BE6112
Catalog page	Page 622 (C-1-2019)
GTIN	4046356962131
Weight per piece (including packing)	312.9 g
Weight per piece (excluding packing)	312.9 g
Customs tariff number	85369010
Country of origin	PL

PTWE 6-2/10 - Test terminal strip



3069833

<https://www.phoenixcontact.com/us/products/3069833>

Technical data

Product properties

Product type	Test terminal strip
Number of positions	10
Pitch	8.2 mm
Number of connections	20
Number of rows	1
Potentials	10

Insulation characteristics

Overvoltage category	III
----------------------	-----

Electrical properties

Rated surge voltage	4 kV
Maximum power dissipation for nominal condition	1.31 W
Test surge voltage	5 kV

Connection data

Number of connections per level	20
Nominal cross section	6 mm ²

1 level

Stripping length	12 mm
Internal cylindrical gage	A5
Connection in acc. with standard	IEC 60947-7-1
Conductor cross section rigid	0.5 mm ² ... 10 mm ²
Cross section AWG	20 ... 8 (converted acc. to IEC)
Conductor cross section flexible	0.5 mm ² ... 6 mm ²
Conductor cross section, flexible [AWG]	20 ... 10 (converted acc. to IEC)
Conductor cross-section flexible (ferrule without plastic sleeve)	0.5 mm ² ... 6 mm ²
Flexible conductor cross section (ferrule with plastic sleeve)	0.5 mm ² ... 6 mm ²
2 conductors with the same cross section, flexible, with TWIN ferrule with plastic sleeve	0.5 mm ² ... 1.5 mm ²
Maximum load current	30 A (with 6 mm ² conductor cross section)
Nominal voltage	400 V AC/DC
Nominal cross section	6 mm ²

1 level Connection cross sections directly pluggable

Conductor cross section rigid	1 mm ² ... 10 mm ²
Conductor cross-section flexible (ferrule without plastic sleeve)	1 mm ² ... 6 mm ²
Flexible conductor cross section (ferrule with plastic sleeve)	1 mm ² ... 6 mm ²

Dimensions

PTWE 6-2/10 - Test terminal strip

3069833

<https://www.phoenixcontact.com/us/products/3069833>

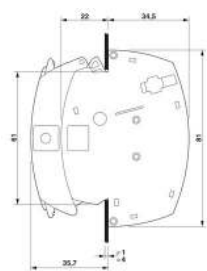
Dimensional drawing	
Width	114.8 mm
Height	81 mm
Depth	56.5 mm
Pitch	8.2 mm
Plate thickness	1 mm ... 4 mm

Material specifications

Color	gray
Flammability rating according to UL 94	V0
Insulating material group	I
Insulating material	PA
Static insulating material application in cold	-60 °C
Temperature index of insulation material (DIN EN 60216-1 (VDE 0304-21))	125 °C
Relative insulation material temperature index (Elec., UL 746 B)	130 °C
Fire protection for rail vehicles (DIN EN 45545-2) R22	HL 1 - HL 3
Fire protection for rail vehicles (DIN EN 45545-2) R23	HL 1 - HL 3
Fire protection for rail vehicles (DIN EN 45545-2) R24	HL 1 - HL 3
Fire protection for rail vehicles (DIN EN 45545-2) R26	HL 1 - HL 3
Calorimetric heat release NFPA 130 (ASTM E 1354)	27,5 MJ/kg
Surface flammability NFPA 130 (ASTM E 162)	passed
Specific optical density of smoke NFPA 130 (ASTM E 662)	passed
Smoke gas toxicity NFPA 130 (SMP 800C)	passed

Electrical tests

Surge voltage test

Test voltage setpoint	4.8 kV
Result	Test passed

Temperature-rise test

Requirement temperature-rise test	Increase in temperature \leq 45 K
Result	Test passed
Short-time withstand current 4 mm ²	0.5 kA
	0.3 kA
	0.15 kA
Result	Test passed

PTWE 6-2/10 - Test terminal strip



3069833

<https://www.phoenixcontact.com/us/products/3069833>

Power-frequency withstand voltage

Test voltage setpoint	1.89 kV
Result	Test passed

Mechanical properties

General

Terminal block mounting	0.8 Nm ... 1 Nm
-------------------------	-----------------

Mechanical data

Open side panel	No
-----------------	----

Mechanical tests

Mechanical strength

Result	Test passed
--------	-------------

Attachment on the carrier

Test force setpoint	5 N
Result	Test passed
Note	Dimensions panel cutout see appendix.

Test for conductor damage and slackening

Rotation speed	10 rpm
Revolutions	135
Conductor cross section/weight	0.5 mm ² / 0.3 kg
	6 mm ² / 1.4 kg
	10 mm ² / 2 kg
Result	Test passed

Environmental and real-life conditions

Aging

Temperature cycles	192
Result	Test passed

Needle-flame test

Time of exposure	30 s
Result	Test passed

Oscillation/broadband noise

Specification	DIN EN 50155 (VDE 0115-200):2008-03
Spectrum	Service life test category 2, bogie-mounted
Frequency	$f_1 = 5 \text{ Hz}$ to $f_2 = 250 \text{ Hz}$
ASD level	6.12 (m/s ²) ² /Hz
Acceleration	3.12g
Test duration per axis	5 h
Test directions	X-, Y- and Z-axis

PTWE 6-2/10 - Test terminal strip



3069833

<https://www.phoenixcontact.com/us/products/3069833>

Result	Test passed
--------	-------------

Shocks

Specification	DIN EN 50155 (VDE 0115-200):2008-03
Pulse shape	Half-sine
Acceleration	30g
Shock duration	18 ms
Number of shocks per direction	3
Test directions	X-, Y- and Z-axis (pos. and neg.)
Result	Test passed

Ambient conditions

Ambient temperature (operation)	-60 °C ... 105 °C (max. short-term operating temperature RTI Elec.)
Ambient temperature (storage/transport)	-25 °C ... 60 °C (for a short time, not exceeding 24 h, -60 °C to +70 °C)
Ambient temperature (assembly)	-5 °C ... 70 °C
Ambient temperature (actuation)	-5 °C ... 70 °C
Permissible humidity (storage/transport)	30 % ... 70 %

Standards and regulations

Connection in acc. with standard	IEC 60947-7-1
----------------------------------	---------------

Mounting

Mounting type	Wall mounting
Plate thickness	1 mm ... 4 mm
Terminal block mounting	0.8 Nm ... 1 Nm

PTWE 6-2/10 - Test terminal strip

3069833

<https://www.phoenixcontact.com/us/products/3069833>

Drawings

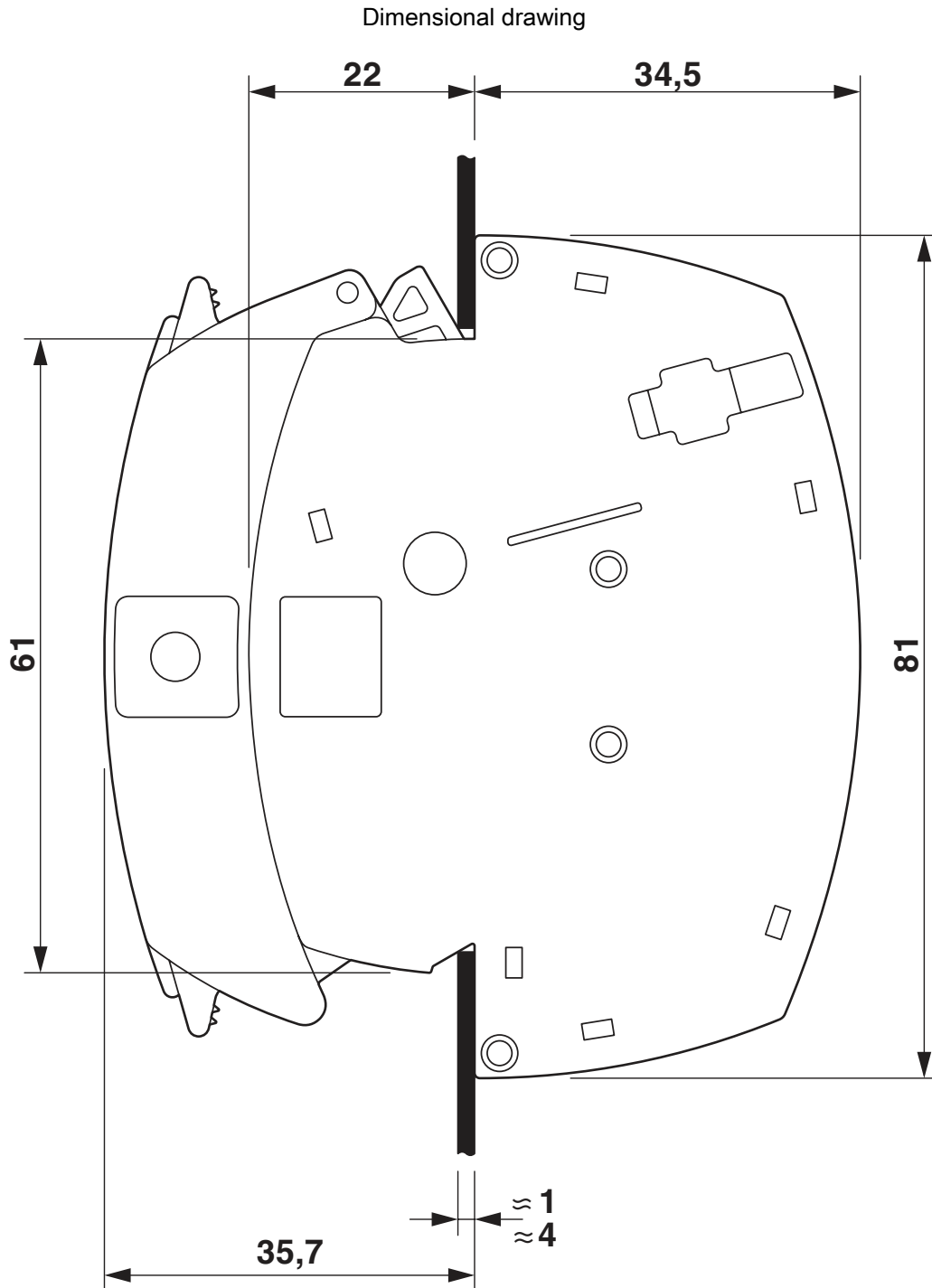

PTWE 6-2/10 - Test terminal strip

3069833

<https://www.phoenixcontact.com/us/products/3069833>



Dimensional drawing

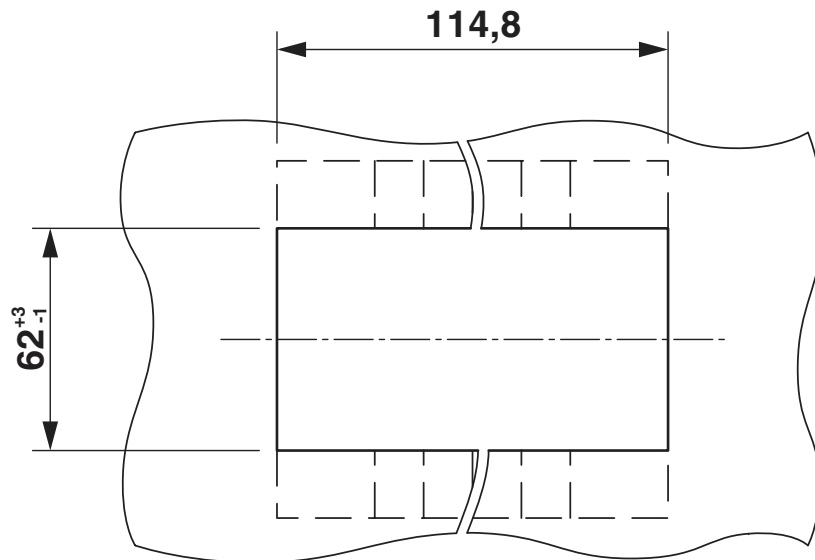

Circuit diagram

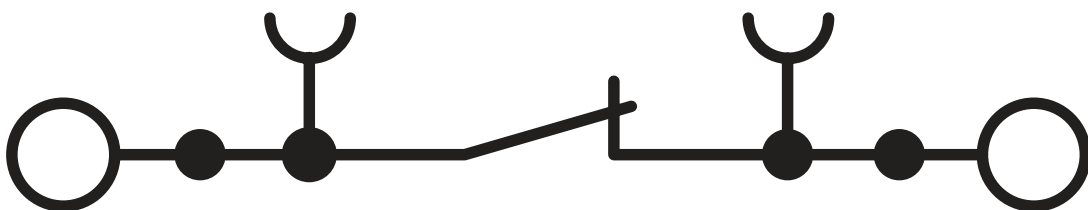

PTWE 6-2/10 - Test terminal strip





3069833

<https://www.phoenixcontact.com/us/products/3069833>

Approvals

To download certificates, visit the product detail page: <https://www.phoenixcontact.com/us/products/3069833>

 CSA Approval ID: 13631				
	Nominal voltage U_N	Nominal current I_N	Cross section AWG	Cross section mm^2
Use group B	600 V	20 A	20 - 8	-
Use group C	600 V	20 A	20 - 8	-

 EAC Approval ID: RU C-DE.BL08.B.00682				
---	--	--	--	--

 cULus Recognized Approval ID: E60425				
	Nominal voltage U_N	Nominal current I_N	Cross section AWG	Cross section mm^2
Use group B	600 V	20 A	20 - 8	-
Use group C	600 V	20 A	20 - 8	-

PTWE 6-2/10 - Test terminal strip



3069833

<https://www.phoenixcontact.com/us/products/3069833>

Classifications

ECLASS

ECLASS-11.0	27141126
ECLASS-12.0	27141126
ECLASS-13.0	27250190

ETIM

ETIM 8.0	EC000902
----------	----------

UNSPSC

UNSPSC 21.0	39121400
-------------	----------

PTWE 6-2/10 - Test terminal strip



3069833

<https://www.phoenixcontact.com/us/products/3069833>

Environmental product compliance

China RoHS	Environmentally friendly use period: unlimited = EFUP-e
	No hazardous substances above threshold values

PTWE 6-2/10 - Test terminal strip

3069833

<https://www.phoenixcontact.com/us/products/3069833>



Accessories

i Note: Applying some accessories below might limit this product.

FBS 2-8 - Plug-in bridge

3030284

<https://www.phoenixcontact.com/us/products/3030284>



Plug-in bridge, pitch: 8.2 mm, number of positions: 2, color: red

i Max. current carrying capacity: 24 A

FBS 3-8 - Plug-in bridge

3030297

<https://www.phoenixcontact.com/us/products/3030297>



Plug-in bridge, pitch: 8.2 mm, number of positions: 3, color: red

i Max. current carrying capacity: 24 A

PTWE 6-2/10 - Test terminal strip

3069833

<https://www.phoenixcontact.com/us/products/3069833>



FBS 4-8 - Plug-in bridge

3030307

<https://www.phoenixcontact.com/us/products/3030307>



Plug-in bridge, pitch: 8.2 mm, number of positions: 4, color: red

 Max. current carrying capacity: 24 A

FBS 5-8 - Plug-in bridge

3030310

<https://www.phoenixcontact.com/us/products/3030310>



Plug-in bridge, pitch: 8.2 mm, number of positions: 5, color: red

 Max. current carrying capacity: 24 A

PTWE 6-2/10 - Test terminal strip

3069833

<https://www.phoenixcontact.com/us/products/3069833>



FBS 6-8 - Plug-in bridge

3032470

<https://www.phoenixcontact.com/us/products/3032470>



Plug-in bridge, pitch: 8.2 mm, number of positions: 6, color: red

 Max. current carrying capacity: 24 A

FBS 10-8 - Plug-in bridge

3030323

<https://www.phoenixcontact.com/us/products/3030323>



Plug-in bridge, pitch: 8.2 mm, number of positions: 10, color: red

 Max. current carrying capacity: 24 A

PTWE 6-2/10 - Test terminal strip

3069833

<https://www.phoenixcontact.com/us/products/3069833>



FBSR 16-8 - Plug-in bridge

3033816

<https://www.phoenixcontact.com/us/products/3033816>



Plug-in bridge, pitch: 8.2 mm, number of positions: 16, color: red

 Max. current carrying capacity: 24 A

FBS 1/3-8 - Plug-in bridge

3032363

<https://www.phoenixcontact.com/us/products/3032363>



Plug-in bridge, pitch: 8.2 mm, number of positions: 3, pin assignment: 1,3, color: red

 Max. current carrying capacity: 24 A

PTWE 6-2/10 - Test terminal strip

3069833

<https://www.phoenixcontact.com/us/products/3069833>



FBS 1/4-8 - Plug-in bridge

3032376

<https://www.phoenixcontact.com/us/products/3032376>



Plug-in bridge, pitch: 8.2 mm, number of positions: 4, pin assignment: 1, 4, color: red

 Max. current carrying capacity: 24 A

FBS 1/3/5-8 - Plug-in bridge

3032389

<https://www.phoenixcontact.com/us/products/3032389>



Plug-in bridge, pitch: 8.2 mm, number of positions: 5, pin assignment: 1,3,5, color: red

 Max. current carrying capacity: 24 A

PTWE 6-2/10 - Test terminal strip

3069833

<https://www.phoenixcontact.com/us/products/3069833>



FBS 1/4/7/10-8 - Plug-in bridge

3032402

<https://www.phoenixcontact.com/us/products/3032402>



Plug-in bridge, pitch: 8.2 mm, number of positions: 10, pin assignment: 1,4,7,10, color: red

 Max. current carrying capacity: 24 A

FBS 2-8 CT - Plug-in bridge

3033830

<https://www.phoenixcontact.com/us/products/3033830>



Plug-in bridge, pitch: 8.2 mm, number of positions: 2, color: orange

 Max. current carrying capacity: 24 A

PTWE 6-2/10 - Test terminal strip

3069833

<https://www.phoenixcontact.com/us/products/3069833>



FBS 3-8 CT - Plug-in bridge

3033831

<https://www.phoenixcontact.com/us/products/3033831>



Plug-in bridge, pitch: 8.2 mm, number of positions: 3, color: orange

 Max. current carrying capacity: 24 A

FBS 4-8 CT - Plug-in bridge

3033832

<https://www.phoenixcontact.com/us/products/3033832>



Plug-in bridge, pitch: 8.2 mm, number of positions: 4, color: orange

 Max. current carrying capacity: 24 A

PTWE 6-2/10 - Test terminal strip

3069833

<https://www.phoenixcontact.com/us/products/3069833>



FBS 10-8 CT - Plug-in bridge

3033833

<https://www.phoenixcontact.com/us/products/3033833>



Plug-in bridge, pitch: 8.2 mm, number of positions: 10, color: orange

 Max. current carrying capacity: 24 A

FBS 2-8 BU - Plug-in bridge

3032567

<https://www.phoenixcontact.com/us/products/3032567>



Plug-in bridge, pitch: 8.2 mm, number of positions: 2, color: blue

 Max. current carrying capacity: 24 A

PTWE 6-2/10 - Test terminal strip

3069833

<https://www.phoenixcontact.com/us/products/3069833>



FBS 3-8 BU - Plug-in bridge

3032570

<https://www.phoenixcontact.com/us/products/3032570>



Plug-in bridge, pitch: 8.2 mm, number of positions: 3, color: blue

 Max. current carrying capacity: 24 A

FBS 4-8 BU - Plug-in bridge

3032583

<https://www.phoenixcontact.com/us/products/3032583>



Plug-in bridge, pitch: 8.2 mm, number of positions: 4, color: blue

 Max. current carrying capacity: 24 A

PTWE 6-2/10 - Test terminal strip

3069833

<https://www.phoenixcontact.com/us/products/3069833>



FBS 5-8 BU - Plug-in bridge

3032596

<https://www.phoenixcontact.com/us/products/3032596>



Plug-in bridge, pitch: 8.2 mm, number of positions: 5, color: blue

 Max. current carrying capacity: 24 A

FBS 6-8 BU - Plug-in bridge

3032677

<https://www.phoenixcontact.com/us/products/3032677>



Plug-in bridge, pitch: 8.2 mm, number of positions: 6, color: blue

 Max. current carrying capacity: 24 A

PTWE 6-2/10 - Test terminal strip

3069833

<https://www.phoenixcontact.com/us/products/3069833>



FBS 10-8 BU - Plug-in bridge

3032606

<https://www.phoenixcontact.com/us/products/3032606>



Plug-in bridge, pitch: 8.2 mm, number of positions: 10, color: blue

 Max. current carrying capacity: 24 A

SZF 2-0,8X4,0 - Screwdriver

1204520

<https://www.phoenixcontact.com/us/products/1204520>



Actuation tool, for ST terminal blocks, also suitable for use as a bladed screwdriver, size: 0.8 x 4.0 x 100 mm, 2-component grip, with non-slip grip

PTWE 6-2/10 - Test terminal strip

3069833

<https://www.phoenixcontact.com/us/products/3069833>



PT-IL - Mounting material

3208090

<https://www.phoenixcontact.com/us/products/3208090>

Operating decal for the push-in Technology



FTPR-2/10 - Test plug

3001688

<https://www.phoenixcontact.com/us/products/3001688>

Test plug, Freely configurable, with twist grip, nom. voltage: 400 V, nominal current: 24 A, Rated cross section: 2.5 mm², color: gray



PTWE 6-2/10 - Test terminal strip

3069833

<https://www.phoenixcontact.com/us/products/3069833>



FTP-2/10 - Test plug

3001712

<https://www.phoenixcontact.com/us/products/3001712>

Test plug, freely configurable, nom. voltage: 400 V, nominal current: 24 A, Rated cross section: 2.5 mm², color: gray



FBP-2/10 - Blind plug

3069881

<https://www.phoenixcontact.com/us/products/3069881>

Blind plug, pitch: 8.2 mm, length: 72.9 mm, width: 114.4 mm, height: 72.9 mm, number of positions: 10, color: gray, mounting type: Insertion in base strip



PTWE 6-2/10 - Test terminal strip

3069833

<https://www.phoenixcontact.com/us/products/3069833>



AP RSC-T - Cover profile

3059139

<https://www.phoenixcontact.com/us/products/3059139>



Cover profile, for covering terminal strips, directly snapped onto RBO... and RSC... test disconnect terminal blocks. Length supplied: 1 m

APH-UTWE 6-2 - Cover profile carrier

3069057

<https://www.phoenixcontact.com/us/products/3069057>



Cover profile carrier, material: PA, color: gray

PTWE 6-2/10 - Test terminal strip

3069833

<https://www.phoenixcontact.com/us/products/3069833>



PC-UTWE-TRI - Coding profile

3069897

<https://www.phoenixcontact.com/us/products/3069897>



Coding profile, For UTWE 6-2 and UTRE 6-2 block, design: delta, length: 44.7 mm, width: 10.7 mm, height: 44.7 mm, color: red, mounting type: Snap in

FTP-2/2 SERVICE - Test plug

3069464

<https://www.phoenixcontact.com/us/products/3069464>



Test plug, nom. voltage: 400 V, nominal current: 24 A, Rated cross section: 2.5 mm², color: red

PTWE 6-2/10 - Test terminal strip

3069833

<https://www.phoenixcontact.com/us/products/3069833>



FTP-2/3 SERVICE - Test plug

3069465

<https://www.phoenixcontact.com/us/products/3069465>



Test plug, nom. voltage: 400 V, nominal current: 24 A, Rated cross section: 2.5 mm², color: red

FTP-2/1 SERVICE 0R1 - Test plug

3069466

<https://www.phoenixcontact.com/us/products/3069466>



Test plug, with integrated resistance of 100 mOhm, 3 W, nom. voltage: 400 V, nominal current: 1 A, Rated cross section: 2.5 mm², color: red

PTWE 6-2/10 - Test terminal strip

3069833

<https://www.phoenixcontact.com/us/products/3069833>



FTP-2/4 SERVICE - Test plug

3069468

<https://www.phoenixcontact.com/us/products/3069468>



Test plug, nom. voltage: 400 V, nominal current: 24 A, Rated cross section: 2.5 mm², color: red

FTP-2/1 SERVICE - Test plug

3069469

<https://www.phoenixcontact.com/us/products/3069469>



Test plug, nom. voltage: 400 V, nominal current: 24 A, Rated cross section: 2.5 mm², color: red

PTWE 6-2/10 - Test terminal strip

3069833

<https://www.phoenixcontact.com/us/products/3069833>



PAI-4-N GY - Test adapter

3032871

<https://www.phoenixcontact.com/us/products/3032871>



4 mm test adapter, for terminal blocks with 5.2 mm, 6.2 mm and 8.2 mm pitch

PAI-4-FIX BU - Test adapter

3032729

<https://www.phoenixcontact.com/us/products/3032729>



Test adapter, Touch proof against unintentional direct contact according to DIN EN 50274 when plugged in, for 4 mm test plug and terminal blocks with 8.2 mm pitch, number of positions: 1, color: blue

PTWE 6-2/10 - Test terminal strip

3069833

<https://www.phoenixcontact.com/us/products/3069833>



PAI-4-FIX OG - Test adapter

3034455

<https://www.phoenixcontact.com/us/products/3034455>



4 mm test adapter, for terminal blocks with 8.2 mm pitch

PAI-4-FIX YE - Test adapter

3032745

<https://www.phoenixcontact.com/us/products/3032745>



Test adapter, Touch proof against unintentional direct contact according to DIN EN 50274 when plugged in, for 4 mm test plug and terminal blocks with 8.2 mm pitch, number of positions: 1, color: yellow

PTWE 6-2/10 - Test terminal strip

3069833

<https://www.phoenixcontact.com/us/products/3069833>



PAI-4-FIX RD - Test adapter

3032732

<https://www.phoenixcontact.com/us/products/3032732>



Test adapter, Touch proof against unintentional direct contact according to DIN EN 50274 when plugged in, for 4 mm test plug and terminal blocks with 8.2 mm pitch, number of positions: 1, color: red

PAI-4-FIX GN - Test adapter

3032758

<https://www.phoenixcontact.com/us/products/3032758>



Test adapter, Touch proof against unintentional direct contact according to DIN EN 50274 when plugged in, for 4 mm test plug and terminal blocks with 8.2 mm pitch, number of positions: 1, color: green

PTWE 6-2/10 - Test terminal strip

3069833

<https://www.phoenixcontact.com/us/products/3069833>



PAI-4-FIX BK - Test adapter

3032774

<https://www.phoenixcontact.com/us/products/3032774>



Test adapter, Touch proof against unintentional direct contact according to DIN EN 50274 when plugged in, for 4 mm test plug and terminal blocks with 8.2 mm pitch, number of positions: 1, color: black

PAI-4-FIX GY - Test adapter

3032790

<https://www.phoenixcontact.com/us/products/3032790>



Test adapter, Touch proof against unintentional direct contact according to DIN EN 50274 when plugged in, for 4 mm test plug and terminal blocks with 8.2 mm pitch, number of positions: 1, color: gray

PTWE 6-2/10 - Test terminal strip

3069833

<https://www.phoenixcontact.com/us/products/3069833>



PAI-4-FIX VT - Test adapter

3032761

<https://www.phoenixcontact.com/us/products/3032761>



Test adapter, Touch proof against unintentional direct contact according to DIN EN 50274 when plugged in, for 4 mm test plug and terminal blocks with 4.2 mm .. 8.2 mm pitch, number of positions: 1, color: violet

PAI-4-FIX BN - Test adapter

3032787

<https://www.phoenixcontact.com/us/products/3032787>



Test adapter, Touch proof against unintentional direct contact according to DIN EN 50274 when plugged in, for 4 mm test plug and terminal blocks with 8.2 mm pitch, number of positions: 1, color: brown

PTWE 6-2/10 - Test terminal strip

3069833

<https://www.phoenixcontact.com/us/products/3069833>



PAI-4-FIX WH - Test adapter

3032797

<https://www.phoenixcontact.com/us/products/3032797>



4 mm test adapter, for terminal blocks with 8.2 mm pitch

PAIS-4-FIX GY - Test adapter

3032791

<https://www.phoenixcontact.com/us/products/3032791>



Test adapter, Touch proof against unintentional direct contact according to DIN EN 50274 when plugged in, for 4 mm test plug and terminal blocks with 5.2 mm, 6.2 mm, and 8.2 mm pitch, number of positions: 1, color: gray

PTWE 6-2/10 - Test terminal strip

3069833

<https://www.phoenixcontact.com/us/products/3069833>



PAIS-4-FIX BK - Test adapter

3032792

<https://www.phoenixcontact.com/us/products/3032792>



Test adapter, Touch proof against unintentional direct contact according to DIN EN 50274 when plugged in, for 4 mm test plug and terminal blocks with 5.2 mm, 6.2 mm, and 8.2 mm pitch, number of positions: 1, color: black

PAIS-4-FIX RD - Test adapter

3032793

<https://www.phoenixcontact.com/us/products/3032793>



Test adapter, Do not plug in while the power is connected, for 4 mm test plug and terminal blocks with 5.2 mm, 6.2 mm, and 8.2 mm pitch, number of positions: 1, color: red

PTWE 6-2/10 - Test terminal strip

3069833

<https://www.phoenixcontact.com/us/products/3069833>



PAIS-4-FIX BU - Test adapter

3032798

<https://www.phoenixcontact.com/us/products/3032798>



Test adapter, Touch proof against unintentional direct contact according to DIN EN 50274 when plugged in, for 4 mm test plug and terminal blocks with 5.2 mm, 6.2 mm, and 8.2 mm pitch, number of positions: 1, color: blue

PAIS-4-FIX YE - Test adapter

3032799

<https://www.phoenixcontact.com/us/products/3032799>



Test adapter, Touch proof against unintentional direct contact according to DIN EN 50274 when plugged in, for 4 mm test plug and terminal blocks with 5.2 mm, 6.2 mm, and 8.2 mm pitch, number of positions: 1, color: yellow

PTWE 6-2/10 - Test terminal strip

3069833

<https://www.phoenixcontact.com/us/products/3069833>



PAIS-4-FIX GN - Test adapter

3032801

<https://www.phoenixcontact.com/us/products/3032801>



Test adapter, Touch proof against unintentional direct contact according to DIN EN 50274 when plugged in, for 4 mm test plug and terminal blocks with 5.2 mm, 6.2 mm, and 8.2 mm pitch, number of positions: 1, color: green

PAIS-4-FIX VT - Test adapter

3032802

<https://www.phoenixcontact.com/us/products/3032802>



Test adapter, Touch proof against unintentional direct contact according to DIN EN 50274 when plugged in, for 4 mm test plug and terminal blocks with 5.2 mm, 6.2 mm, and 8.2 mm pitch, number of positions: 1, color: violet

PTWE 6-2/10 - Test terminal strip

3069833

<https://www.phoenixcontact.com/us/products/3069833>



PSBJ-URTK 6 FARBLOS - Female test connector

3026450

<https://www.phoenixcontact.com/us/products/3026450>



Female test connector, number of positions: 1, color: transparent

PSBJ-URTK 6 RD - Female test connector

3026719

<https://www.phoenixcontact.com/us/products/3026719>



Female test connector, number of positions: 1, color: red

PTWE 6-2/10 - Test terminal strip

3069833

<https://www.phoenixcontact.com/us/products/3069833>



PSBJ-URTK 6 BU - Female test connector

3026434

<https://www.phoenixcontact.com/us/products/3026434>



Female test connector, number of positions: 1, color: blue

PSBJ-URTK 6 YE - Female test connector

3026405

<https://www.phoenixcontact.com/us/products/3026405>



Female test connector, number of positions: 1, color: yellow

PTWE 6-2/10 - Test terminal strip

3069833

<https://www.phoenixcontact.com/us/products/3069833>



PSBJ-URTK 6 GN - Female test connector

3026418

<https://www.phoenixcontact.com/us/products/3026418>



Female test connector, number of positions: 1, color: green

PSBJ-URTK 6 VT - Female test connector

3026421

<https://www.phoenixcontact.com/us/products/3026421>



Female test connector, number of positions: 1, color: violet

PTWE 6-2/10 - Test terminal strip

3069833

<https://www.phoenixcontact.com/us/products/3069833>



PSBJ-URTK 6 GY - Female test connector

3026612

<https://www.phoenixcontact.com/us/products/3026612>



Female test connector, number of positions: 1, color: gray

PSBJ-URTK 6 BK - Female test connector

3026447

<https://www.phoenixcontact.com/us/products/3026447>



Female test connector, number of positions: 1, color: black

PTWE 6-2/10 - Test terminal strip

3069833

<https://www.phoenixcontact.com/us/products/3069833>



PSBJ-URTK 6 BN - Female test connector

3026971

<https://www.phoenixcontact.com/us/products/3026971>



Female test connector, number of positions: 1, color: brown

PSBJ-URTK 6 WH - Female test connector

3026448

<https://www.phoenixcontact.com/us/products/3026448>



Female test connector, number of positions: 1, color: white

PTWE 6-2/10 - Test terminal strip

3069833

<https://www.phoenixcontact.com/us/products/3069833>



ZB 8:UNBEDRUCKT - Zack marker strip

1052002

<https://www.phoenixcontact.com/us/products/1052002>



Zack marker strip, Strip, white, unlabeled, can be labeled with: CMS-P1-PLOTTER, PLOTMARK, mounting type: snapped, for terminal block width: 8.2 mm, lettering field size: 10.5 x 8.15 mm, Number of individual labels: 10

ZB 8 CUS - Zack marker strip

0825011

<https://www.phoenixcontact.com/us/products/0825011>



Zack marker strip, can be ordered: Strip, white, labeled according to customer specifications, mounting type: snap into tall marker groove, for terminal block width: 8.2 mm, lettering field size: 10.5 x 8.15 mm, Number of individual labels: 10

PTWE 6-2/10 - Test terminal strip

3069833

<https://www.phoenixcontact.com/us/products/3069833>



UC-TM 8 - Marker for terminal blocks

0818072

<https://www.phoenixcontact.com/us/products/0818072>



Marker for terminal blocks, Sheet, white, unlabeled, can be labeled with: BLUEMARK ID COLOR, BLUEMARK ID, BLUEMARK CLED, PLOTMARK, CMS-P1-PLOTTER, mounting type: snapped, for terminal block width: 8.2 mm, lettering field size: 7.6 x 10.5 mm, Number of individual labels: 56

UC-TM 8 CUS - Marker for terminal blocks

0824597

<https://www.phoenixcontact.com/us/products/0824597>



Marker for terminal blocks, can be ordered: by sheet, white, labeled according to customer specifications, mounting type: snap into tall marker groove, for terminal block width: 8.2 mm, lettering field size: 7.6 x 10.5 mm, Number of individual labels: 56

PTWE 6-2/10 - Test terminal strip

3069833

<https://www.phoenixcontact.com/us/products/3069833>



UCT-TM 8 - Marker for terminal blocks

0828740

<https://www.phoenixcontact.com/us/products/0828740>



Marker for terminal blocks, Sheet, white, unlabeled, can be labeled with: TOPMARK NEO, TOPMARK LASER, BLUEMARK ID COLOR, BLUEMARK ID, BLUEMARK CLED, THERMOMARK PRIME, THERMOMARK CARD 2.0, THERMOMARK CARD, mounting type: snapped, for terminal block width: 8.2 mm, lettering field size: 7.6 x 10.5 mm, Number of individual labels: 42

UCT-TM 8 CUS - Marker for terminal blocks

0829616

<https://www.phoenixcontact.com/us/products/0829616>



Marker for terminal blocks, can be ordered: by sheet, white, labeled according to customer specifications, mounting type: snap into tall marker groove, for terminal block width: 8.2 mm, lettering field size: 7.6 x 10.5 mm, Number of individual labels: 42

PTWE 6-2/10 - Test terminal strip

3069833

<https://www.phoenixcontact.com/us/products/3069833>



ZB 8,LGS:FORTL.ZAHLEN - Zack marker strip

1052015

<https://www.phoenixcontact.com/us/products/1052015>



Zack marker strip, Strip, white, labeled, can be labeled with: CMS-P1-PLOTTER, printed horizontally: consecutive numbers 1 ... 10, 11 ... 20, etc. up to 91 ... 100, mounting type: snapped, for terminal block width: 8.2 mm, lettering field size: 10. 5 x 8.15 mm, Number of individual labels: 10

ZB 8,QR:FORTL.ZAHLEN - Zack marker strip

1052028

<https://www.phoenixcontact.com/us/products/1052028>



Zack marker strip, Strip, white, labeled, can be labeled with: CMS-P1-PLOTTER, Printed vertically: consecutive numbers 1 ... 10, 11 ... 20, etc. up to 91 ... 100, mounting type: snapped, for terminal block width: 8.2 mm, lettering field size: 10. 5 x 8.15 mm, Number of individual labels: 10

PTWE 6-2/10 - Test terminal strip

3069833

<https://www.phoenixcontact.com/us/products/3069833>



ZB 8,LGS:L1-N,PE - Marker for terminal blocks

1052413

<https://www.phoenixcontact.com/us/products/1052413>



Marker for terminal blocks, Strip, white, labeled, can be labeled with: CMS-P1-PLOTTER, horizontal: L1, L2, L3, N, PE, L1, L2, L3, N, PE, mounting type: snapped, for terminal block width: 8.2 mm, lettering field size: 10.5 x 8.15 mm, Number of individual labels: 10

TMT (EX9,5)R - Marker for terminal blocks

0828295

<https://www.phoenixcontact.com/us/products/0828295>



Marker for terminal blocks, Roll, white, unlabeled, can be labeled with: THERMOMARK E.300 (D)/600 (D), THERMOMARK ROLL 2.0, THERMOMARK ROLL, THERMOMARK ROLL X1, THERMOMARK ROLLMASTER 300/600, THERMOMARK X1.2, mounting type: snapped, snap into tall marker groove, for terminal block width: 30000 mm, lettering field size: 9.5 x 50000 mm, Number of individual labels: 1

PTWE 6-2/10 - Test terminal strip

3069833

<https://www.phoenixcontact.com/us/products/3069833>



US-TM 100 - Marker for terminal blocks

0829255

<https://www.phoenixcontact.com/us/products/0829255>

Marker for terminal blocks, Card, white, unlabeled, can be labeled with: BLUEMARK ID COLOR, BLUEMARK ID, THERMOMARK PRIME, THERMOMARK CARD 2.0, THERMOMARK CARD, mounting type: snapped, lettering field size: 104 x 9.8 mm, Number of individual labels: 13



Phoenix Contact 2023 © - all rights reserved

<https://www.phoenixcontact.com>

Phoenix Contact USA
586 Fulling Mill Road
Middletown, PA 17057, United States
(+717) 944-1300
info@phoenixcon.com