

6 CAP POSITION WITH RESPECT TO CONNECTOR

FOR CKT 10 & BELOW & CKT 14, 18, 22, 26, 30,
34, 38, 42, 46, 50, 54, 58, 62, 66, 70, 74, 78, 82,
86, 90, 94, 98

FOR 12, 16, 20, 24, 28, 32, 36, 40, 44, 48, 52,
56, 60, 64, 68, 72, 76, 80, 84, 86, 92, 96, 100

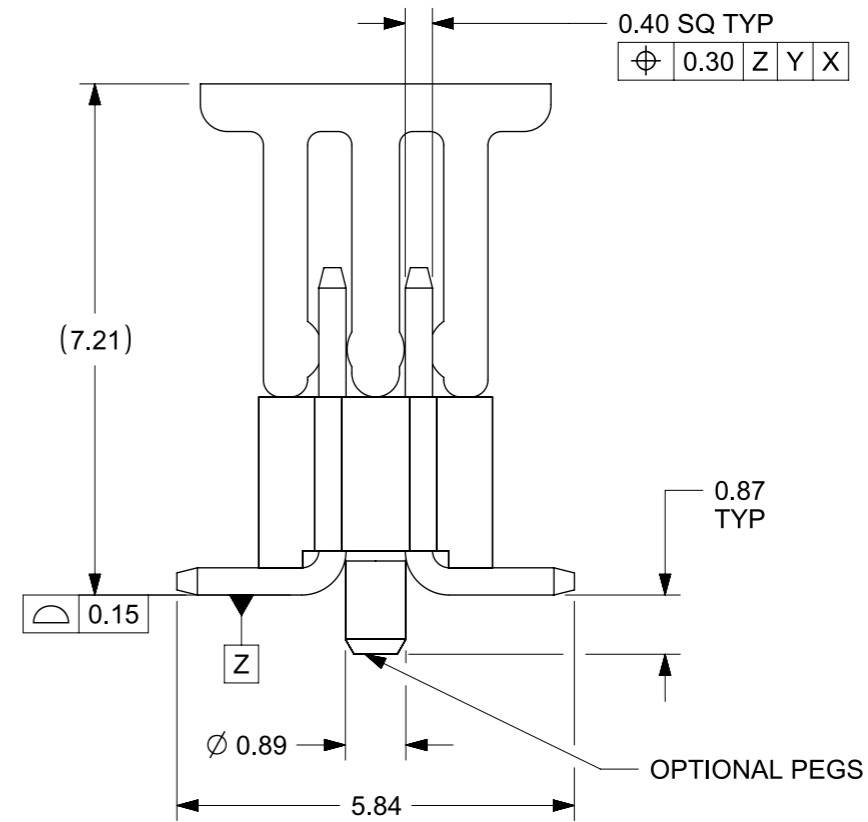
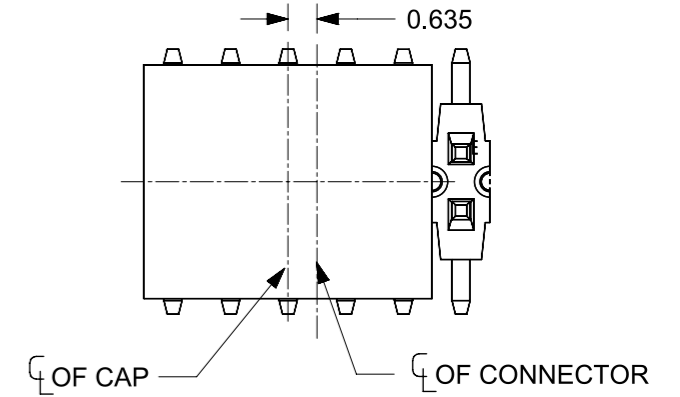
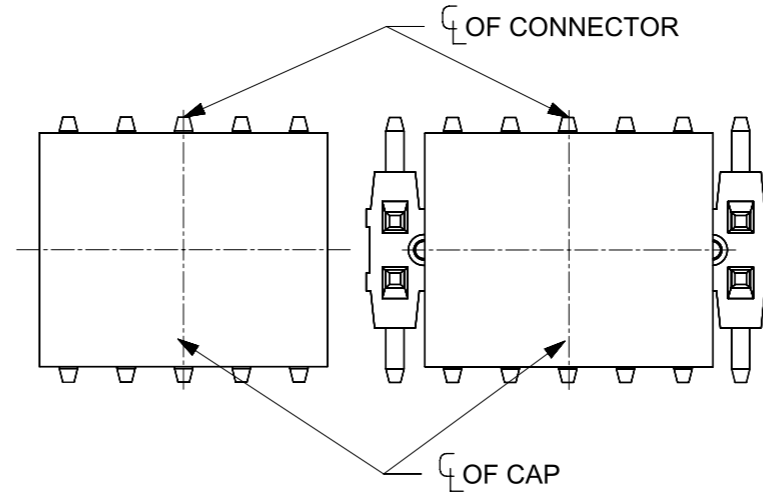

THIS DRAWING CONTAINS INFORMATION THAT IS PROPRIETARY TO MOLEX ELECTRONIC TECHNOLOGIES, LLC AND SHOULD NOT BE USED WITHOUT WRITTEN PERMISSION		CURRENT REV DESC:		molex	
DIMENSION UNITS	SCALE				
mm	NTS			1.27MM PITCH SMT HEADER WITH CAP PACKED IN TUBE	
GENERAL TOLERANCES (UNLESS SPECIFIED)				PRODUCT CUSTOMER DRAWING	
ANGULAR TOL ± 3.0°				DOCUMENT NUMBER	
4 PLACES ±		EC NO: 743277		SD-87933-0001	
3 PLACES ±		DRWN: DANUSA	2022/11/18	DOC TYPE	DOC PART
2 PLACES ±		CHK'D: SUAIFR	2023/03/22	PSD	000
1 PLACE ±		APPR: MRAMAKRISHNA	2023/03/23	REVISION	
0 PLACES ±		INITIAL REVISION:		C5	
DRAFT WHERE APPLICABLE MUST REMAIN WITHIN DIMENSIONS		DRWN: SCHEONG	2016/09/14		
THIRD ANGLE PROJECTION		APPR: SCHEONG	2016/11/10		
DRAWING		SERIES	MATERIAL NUMBER	CUSTOMER	
A3-SIZE		87933	SEE TABLE	GENERAL MARKET	
		SHEET NUMBER		1 OF 6	

CKT SIZE	DIM A	DIM B	DIM C
4	2.54	1.27	-
6	3.81	2.54	-
8	5.08	3.81	-
10	6.35	5.08	3.81
12	7.62	6.35	-
14	8.89	7.62	-
16	10.16	8.89	-
18	11.43	10.16	-
20	12.70	11.43	10.16
22	13.97	12.70	-
24	15.24	13.97	-

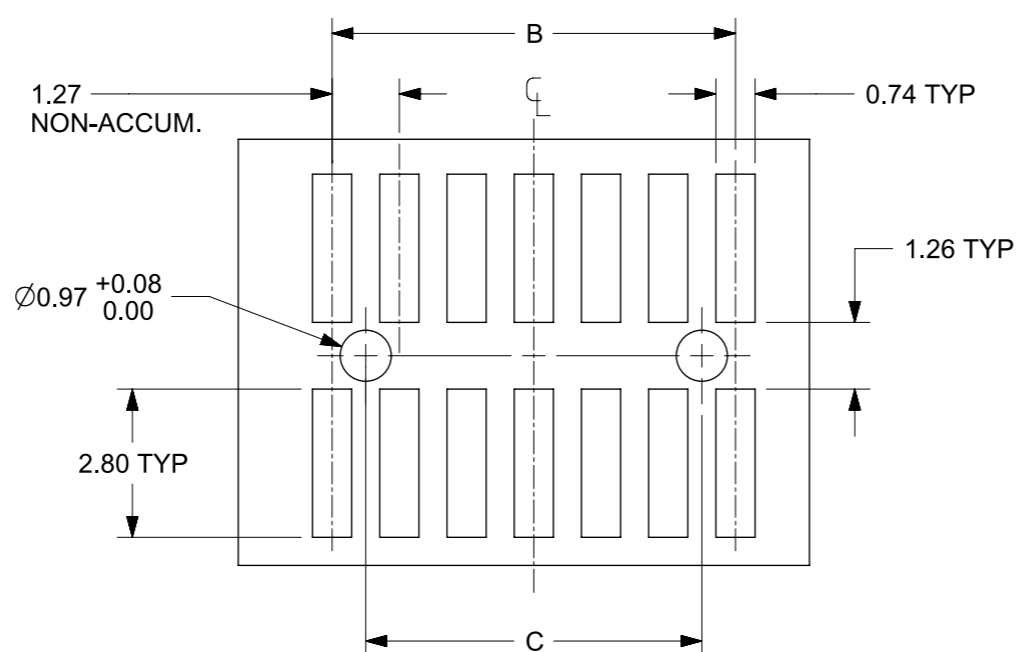

RECOMMENDED PCB LAYOUT
(PARTS WITH PEGS)
MANUFACTURING TOLERANCE ±0.05

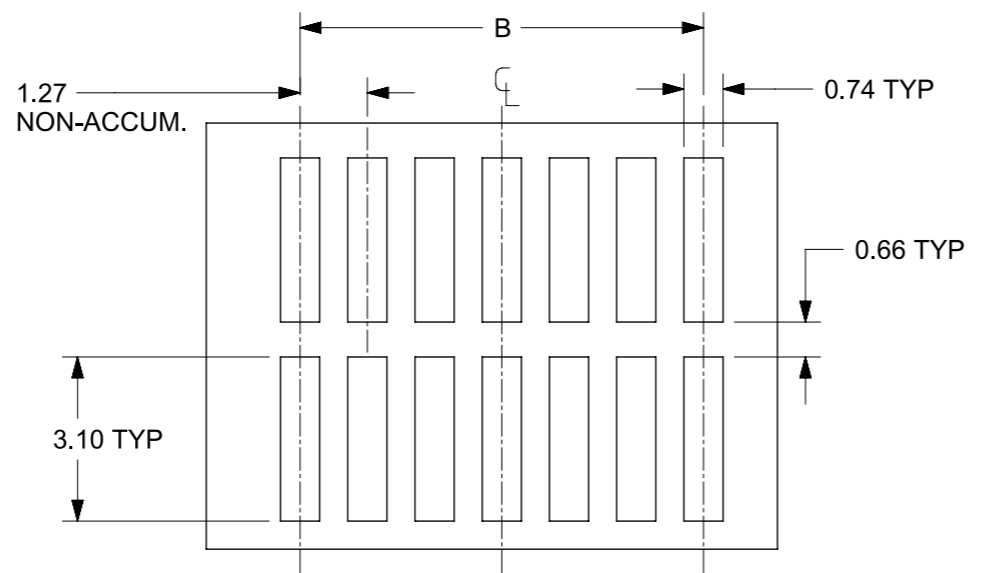

RECOMMENDED PCB LAYOUT
(IMPROVED FOR WITHOUT PEGS OPTION)
MANUFACTURING TOLERANCE ±0.05

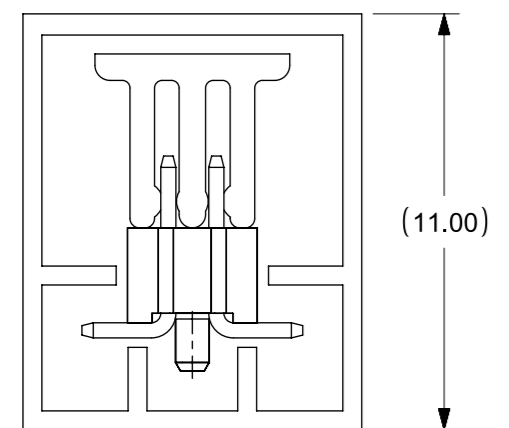

PART WITH PEG & CAP
PACKED IN TUBE

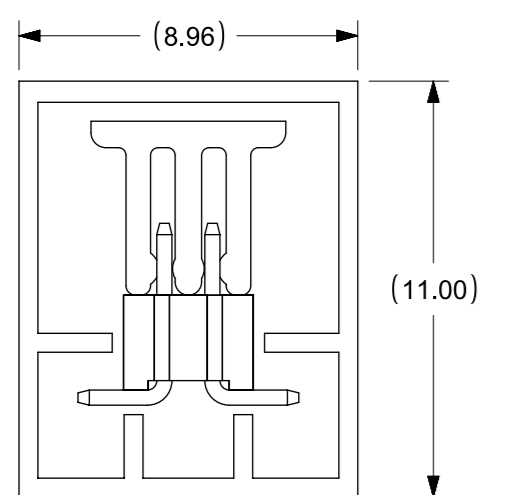

PART WITHOUT PEG &
WITH CAP PACKED IN TUBE

- NOTE:
- MATERIAL: HOUSING: LCP GLASS FILLED, COLOR: BLACK
TERMINAL: COPPER ALLOY
 - PIN PUSHOUT FORCE: 0.4KG MIN. IN EITHER DIRECTION.
 - PLATING FINISH:
 - 2 MICRO INCH MIN. GOLD FLASH OVERALL, 50 MICRO INCH MIN. NICKEL UNDERPLATED
 - 100 MICRO INCH MIN. TIN OVERALL, 50 MICRO INCH MIN. NICKEL UNDERPLATED
 - 30 MICRO INCH MIN. GOLD PLATE IN SELECTED AREA AND 80 MICRO INCH MIN. TIN IN SELECTED AREA OVER, 50 MICRO INCH MIN. NICKEL UNDERPLATED
 - 15 MICRO INCH MIN. GOLD PLATE IN SELECTED AREA AND 80 MICRO INCH MIN. TIN IN SELECTED AREA OVER, 50 MICRO INCH MIN. NICKEL UNDERPLATED
 - 2 MICRO INCH MIN. GOLD FLASH IN SELECTED AREA AND 100 MICRO INCH MIN. TIN IN SELECTED AREA OVER, 50 MICRO INCH MIN. NICKEL UNDERPLATED
 - THE ABOVE 14 CKT SHOWN IS FOR ILLUSTRATION ONLY.
 - PARTS TO BE PACKED IN TUBE EXCEPT FOR 4 CKTS.
 - POSITION OF CAP TO BE LOCATED AS SHOWN.
 - IRREGULAR CIRCUIT CUTOFF WITHIN BREAKAWAY SECTION IS PERMISSIBLE. CUTTING OR CHIPPING OF THE MAIN BODY IS NOT ACCEPTABLE.
 - PACKAGING SPECIFICATION REFER TO
TUBE : PK-89990-565
TAPE & REEL : PK-87933-300
 - PRODUCT SPECIFICATION: 879330001_PS
 - MATED SERIES: 78120 EXCEPT FOR FULL TIN PLATING FINISH
 - PARTS CONFORMS TO CLASS "B" REQUIREMENT TO COSMETIC SPECIFICATION PS-45499-002

THIS DRAWING CONTAINS INFORMATION THAT IS PROPRIETARY TO MOLEX ELECTRONIC TECHNOLOGIES, LLC AND SHOULD NOT BE USED WITHOUT WRITTEN PERMISSION		CURRENT REV DESC:		molex	
DIMENSION UNITS	SCALE				
mm	NTS			1.27MM PITCH SMT HEADER WITH CAP PACKED IN TUBE	
GENERAL TOLERANCES (UNLESS SPECIFIED)				PRODUCT CUSTOMER DRAWING	
ANGULAR TOL	± 3.0 °			DOCUMENT NUMBER	
4 PLACES	±	EC NO: 743277		SD-87933-0001	
3 PLACES	±	DRWN: DANUSA	2022/11/18	DOC TYPE	DOC PART
2 PLACES	± 0.2	CHK'D: SUAIFR	2023/03/22	PSD	000
1 PLACE	±	APPR: MRAMAKRISHNA	2023/03/23	REVISION	
0 PLACES	±	INITIAL REVISION:		C5	
DRAFT WHERE APPLICABLE MUST REMAIN WITHIN DIMENSIONS		DRWN: SCHEONG	2016/09/14		
THIRD ANGLE PROJECTION		APPR: SCHEONG	2016/11/10		
DRAWING		SERIES	MATERIAL NUMBER	CUSTOMER	
A3-SIZE		87933	SEE TABLE	GENERAL MARKET	
				SHEET NUMBER	
				2 OF 6	

	10	9	8	7	6	5	4	3	2	1
	P/N WITH CAP PACKED IN T&R	TOOLED	NOT TOOLED	P/N WITH CAP PACKED IN TUBE	PEG	CKT SIZE	PLATING OPTIONS	DIM. M		
F	87933-0422		X	-	N	04	1	1.65		
	87933-0438		X	-	N	04	2	1.65		
	87933-0439		X	-	N	04	3	1.65		
	87933-0440		X	-	N	04	4	1.65		
	87933-0446		X	-	N	04	5	1.65		
	87933-0441		X	-	N	04	1	1.91		
	87933-0442		X	-	N	04	2	1.91		
	87933-0443		X	-	N	04	3	1.91		
E	87933-0444		X	-	N	04	4	1.91		
	87933-0448		X	-	N	04	5	1.91		
	87933-0425		X	-	N	04	1	3.05		
	87933-0426		X	-	N	04	2	3.05		
	87933-0427		X	-	N	04	3	3.05		
	87933-0428		X	-	N	04	4	3.05		
	87933-0424		X	-	N	04	5	3.05		
	87933-0622	X		87933-0607	N	06	1	1.65		
D	87933-0638	X		87933-0608	N	06	2	1.65		
	87933-0639	X		87933-0609	N	06	3	1.65		
	87933-0640	X		87933-0610	N	06	4	1.65		
	87933-0646	X		87933-0645	N	06	5	1.65		
	87933-0641	X		87933-0611	N	06	1	1.91		
	87933-0642	X		87933-0612	N	06	2	1.91		
	87933-0643	X		87933-0613	N	06	3	1.91		
	87933-0644	X		87933-0614	N	06	4	1.91		
	87933-0648	X		87933-0647	N	06	5	1.91		
C	87933-0625	X		87933-0615	N	06	1	3.05		
	87933-0626	X		87933-0616	N	06	2	3.05		
	87933-0627	X		87933-0617	N	06	3	3.05		
	87933-0628	X		87933-0618	N	06	4	3.05		
	87933-0624	X		87933-0623	N	06	5	3.05		
	87933-0822		X	87933-0807	N	08	1	1.65		
	87933-0838		X	87933-0808	N	08	2	1.65		
	87933-0839		X	87933-0809	N	08	3	1.65		
B	87933-0840		X	87933-0810	N	08	4	1.65		
	87933-0846		X	87933-0845	N	08	5	1.65		
	87933-0841		X	87933-0811	N	08	1	1.91		
	87933-0842		X	87933-0812	N	08	2	1.91		
	87933-0843		X	87933-0813	N	08	3	1.91		
	87933-0844		X	87933-0814	N	08	4	1.91		
	87933-0848		X	87933-0847	N	08	5	1.91		
	87933-0825		X	87933-0815	N	08	1	3.05		
A	87933-0826		X	87933-0816	N	08	2	3.05		
	87933-0827		X	87933-0817	N	08	3	3.05		

	10	9	8	7	6	5	4	3	2	1
	P/N WITH CAP PACKED IN T&R	TOOLED	NOT TOOLED	P/N WITH CAP PACKED IN TUBE	PEG	CKT SIZE	PLATING OPTIONS	DIM. M		
	87933-0828		X	-	N	08	4	3.05		
	87933-0824	X		-	N	08	5	3.05		
	87933-1022	X		-	N	10	1	1.65		
	87933-1038	X		-	N	10	2	1.65		
	87933-1039	X		-	N	10	3	1.65		
	87933-1040	X		-	N	10	4	1.65		
	87933-1046	X		-	N	10	5	1.65		
	87933-1041	X		-	N	10	1	1.91		
	87933-1042	X		-	N	10	2	1.91		
	87933-1043	X		-	N	10	3	1.91		
	87933-1044	X		-	N	10	4	1.91		
	87933-1048	X		-	N	10	5	1.91		
	87933-1025	X		-	N	10	1	3.05		
	87933-1026	X		-	N	10	2	3.05		
	87933-1021	X		-	N	10	3	3.05		
	87933-1028	X		87933-1058	N	10	4	3.05		
	87933-1024	X		-	N	10	5	3.05		
	87933-1237		X	-	N	12	1	1.65		
	87933-1238		X	-	N	12	2	1.65		
	87933-1239		X	-	N	12	3	1.65		
	87933-1240		X	-	N	12	4	1.65		
	87933-1246		X	-	N	12	5	1.65		
	87933-1241		X	-	N	12	1	1.91		
	87933-1242		X	-	N	12	2	1.91		
	87933-1243		X	-	N	12	3	1.91		
	87933-1244		X	-	N	12	4	1.91		
	87933-1248		X	-	N	12	5	1.91		
	87933-1225		X	-	N	12	1	3.05		
	87933-1229		X	-	N	12	2	3.05		
	87933-1227		X	-	N	12	3	3.05		
	87933-1232		X	-	N	12	4	3.05		
	87933-1224		X	-	N	12	5	3.05		

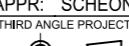
THIS DRAWING CONTAINS INFORMATION THAT IS PROPRIETARY TO MOLEX ELECTRONIC TECHNOLOGIES, LLC AND SHOULD NOT BE USED WITHOUT WRITTEN PERMISSION									
DIMENSION UNITS		SCALE		CURRENT REV DESC:					
mm		NTS		 1.27MM PITCH SMT HEADER WITH CAP PACKED IN TUBE					
GENERAL TOLERANCES (UNLESS SPECIFIED)									
ANGULAR TOL ± 3.0°									
4 PLACES ±									
3 PLACES ±		EC NO: 743277		DRWN: DANUSA		2022/11/18		PRODUCT CUSTOMER DRAWING	
2 PLACES ± 0.2		CHK'D: SUAIFR		APPR: MRAMAKRISHNA		2023/03/22			
1 PLACE ±		INITIAL REVISION:		DRWN: SCHEONG		2016/09/14		DOCUMENT NUMBER	
0 PLACES ±		APPR: SCHEONG		2016/11/10		SD-87933-0001		DOC TYPE DOC PART REVISION	
DRAFT WHERE APPLICABLE MUST REMAIN WITHIN DIMENSIONS		THIRD ANGLE PROJECTION		DRAWING		SERIES		MATERIAL NUMBER	
				A3-SIZE		87933		CUSTOMER	
				SEE TABLE		GENERAL MARKET		SHEET NUMBER	
								3 OF 6	

10	9	8	7	6			
P/N WITH CAP PACKED IN T&R	TOOLED	NOT TOOLED	P/N WITH CAP PACKED IN TUBE	PEG	CKT SIZE	PLATING OPTIONS	DIM. M
87933-1422		X	87933-1407	N	14	1	1.65
87933-1438		X	87933-1408	N	14	2	1.65
87933-1439		X	87933-1409	N	14	3	1.65
87933-1440		X	87933-1410	N	14	4	1.65
87933-1446		X	87933-1445	N	14	5	1.65
87933-1441		X	87933-1411	N	14	1	1.91
87933-1442		X	87933-1412	N	14	2	1.91
87933-1443		X	87933-1413	N	14	3	1.91
87933-1444		X	87933-1414	N	14	4	1.91
87933-1448		X	87933-1447	N	14	5	1.91
87933-1425		X	87933-1415	N	14	1	3.05
87933-1426		X	87933-1416	N	14	2	3.05
87933-1427		X	87933-1417	N	14	3	3.05
87933-1428		X	87933-1418	N	14	4	3.05
87933-1424		X	87933-1423	N	14	5	3.05
87933-1622		X	87933-1607	N	16	1	1.65
87933-1638		X	87933-1608	N	16	2	1.65
87933-1639		X	87933-1609	N	16	3	1.65
87933-1640		X	87933-1610	N	16	4	1.65
87933-1646		X	87933-1645	N	16	5	1.65
87933-1641		X	87933-1611	N	16	1	1.91
87933-1642		X	87933-1612	N	16	2	1.91
87933-1643		X	87933-1613	N	16	3	1.91
87933-1644		X	87933-1614	N	16	4	1.91
87933-1648		X	87933-1647	N	16	5	1.91
87933-1625		X	87933-1615	N	16	1	3.05
87933-1626		X	87933-1616	N	16	2	3.05
87933-1627		X	87933-1617	N	16	3	3.05
87933-1628		X	87933-1618	N	16	4	3.05
87933-1624		X	87933-1623	N	16	5	3.05
87933-1822		X	87933-1807	N	18	1	1.65
87933-1838		X	87933-1808	N	18	2	1.65
87933-1839		X	87933-1809	N	18	3	1.65
87933-1840		X	87933-1810	N	18	4	1.65
87933-1846		X	87933-1845	N	18	5	1.65
87933-1841		X	87933-1811	N	18	1	1.91
87933-1842		X	87933-1812	N	18	2	1.91
87933-1843		X	87933-1813	N	18	3	1.91
87933-1844		X	87933-1814	N	18	4	1.91
87933-1848		X	87933-1847	N	18	5	1.91
87933-1825		X	87933-1815	N	18	1	3.05
87933-1826		X	87933-1816	N	18	2	3.05
87933-1827		X	87933-1817	N	18	3	3.05

5	4	3	2	1			
P/N WITH CAP PACKED IN T&R	TOOLED	NOT TOOLED	P/N WITH CAP PACKED IN TUBE	PEG	CKT SIZE	PLATING OPTIONS	DIM. M
87933-1828	X		87933-1818	N	18	4	3.05
87933-1824	X		87933-1823	N	18	5	3.05
87933-2037	X		87933-2007	N	20	1	1.65
87933-2038	X		87933-2008	N	20	2	1.65
87933-2039	X		87933-2009	N	20	3	1.65
87933-2040	X		87933-2010	N	20	4	1.65
87933-2046	X		87933-2045	N	20	5	1.65
87933-2041	X		87933-2011	N	20	1	1.91
87933-2042	X		87933-2012	N	20	2	1.91
87933-2043	X		87933-2013	N	20	3	1.91
87933-2044	X		87933-2014	N	20	4	1.91
87933-2048	X		87933-2047	N	20	5	1.91
87933-2025	X		87933-2015	N	20	1	3.05
87933-2026	X		87933-2016	N	20	2	3.05
87933-2027	X		87933-2017	N	20	3	3.05
87933-2021	X		87933-2018	N	20	4	3.05
87933-2024	X		87933-2023	N	20	5	3.05
87933-2237		X	87933-2207	N	22	1	1.65
87933-2238		X	87933-2208	N	22	2	1.65
87933-2239		X	87933-2209	N	22	3	1.65
87933-2240		X	87933-2210	N	22	4	1.65
87933-2246		X	87933-2245	N	22	5	1.65
87933-2241		X	87933-2211	N	22	1	1.91
87933-2242		X	87933-2212	N	22	2	1.91
87933-2243		X	87933-2213	N	22	3	1.91
87933-2244		X	87933-2214	N	22	4	1.91
87933-2248		X	87933-2247	N	22	5	1.91
87933-2225		X	87933-2215	N	22	1	3.05
87933-2226		X	87933-2216	N	22	2	3.05
87933-2227		X	87933-2217	N	22	3	3.05
87933-2228		X	87933-2218	N	22	4	3.05
87933-2224		X	87933-2223	N	22	5	3.05

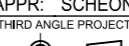
THIS DRAWING CONTAINS INFORMATION THAT IS PROPRIETARY TO MOLEX ELECTRONIC TECHNOLOGIES, LLC AND SHOULD NOT BE USED WITHOUT WRITTEN PERMISSION															
DIMENSION UNITS		SCALE		CURRENT REV DESC:											
mm		NTS													
GENERAL TOLERANCES (UNLESS SPECIFIED)				EC NO: 743277 DRWN: DANUSA 2022/11/18 CHK'D: SUAIFR 2023/03/22 APPR: MRAMAKRISHNA 2023/03/23				PRODUCT CUSTOMER DRAWING							
ANGULAR TOL		± 3.0 °						DOCUMENT NUMBER				DOC TYPE		DOC PART	
4 PLACES		±						SD-87933-0001				PSD		000	
3 PLACES		±						INITIAL REVISION:				DATE		REVISION	
2 PLACES		± 0.2						DRWN: SCHEONG 2016/09/14				2016/11/10		C5	
1 PLACE		±		MATERIAL NUMBER				CUSTOMER		SHEET NUMBER					
0 PLACES		±		THIRD ANGLE PROJECTION		DRAWING		SERIES		GENERAL MARKET					
DRAFT WHERE APPLICABLE MUST REMAIN WITHIN DIMENSIONS						A3-SIZE		87933		4 OF 6					

10	9	8	7	6	5	4	3	2	1
P/N WITH CAP PACKED IN T&R	TOOLED	NOT TOOLED	P/N WITH CAP PACKED IN TUBE	PEG	CKT SIZE	PLATING OPTIONS	DIM. M		
87933-2437		X	87933-2407	N	24	1	1.65		
87933-2438		X	87933-2408	N	24	2	1.65		
87933-2439		X	87933-2409	N	24	3	1.65		
87933-2440		X	87933-2410	N	24	4	1.65		
87933-2446		X	87933-2445	N	24	5	1.65		
87933-2441		X	87933-2411	N	24	1	1.91		
87933-2442		X	87933-2412	N	22	2	1.91		
87933-2443		X	87933-2413	N	24	3	1.91		
87933-2444		X	87933-2414	N	24	4	1.91		
87933-2448		X	87933-2447	N	24	5	1.91		
87933-2425		X	87933-2415	N	24	1	3.05		
87933-2426		X	87933-2416	N	24	2	3.05		
87933-2427		X	87933-2417	N	24	3	3.05		
87933-2428		X	87933-2418	N	24	4	3.05		
87933-2424		X	87933-2423	N	24	5	3.05		

THIS DRAWING CONTAINS INFORMATION THAT IS PROPRIETARY TO MOLEX ELECTRONIC TECHNOLOGIES, LLC AND SHOULD NOT BE USED WITHOUT WRITTEN PERMISSION												
DIMENSION UNITS		SCALE		CURRENT REV DESC:				molex		1.27MM PITCH SMT HEADER WITH CAP PACKED IN TUBE		
mm		NTS										
GENERAL TOLERANCES (UNLESS SPECIFIED)				EC NO: 743277 DRWN: DANUSA 2022/11/18 CHK'D: SUAIFR 2023/03/22 APPR: MRAMAKRISHNA 2023/03/23				PRODUCT CUSTOMER DRAWING				
ANGULAR TOL ± 3.0 °												
4 PLACES		±		INITIAL REVISION: DRWN: SCHEONG 2016/09/14 APPR: SCHEONG 2016/11/10				DOCUMENT NUMBER		DOC TYPE	DOC PART	REVISION
3 PLACES		±						SD-87933-0001		PSD	000	C5
2 PLACES		± 0.2		THIRD ANGLE PROJECTION 				MATERIAL NUMBER		CUSTOMER		SHEET NUMBER
1 PLACE		±						A3-SIZE 87933		SEE TABLE		GENERAL MARKET
0 PLACES		±		DRAFT WHERE APPLICABLE MUST REMAIN WITHIN DIMENSIONS								

DOCUMENT STATUS	P1	RELEASE DATE	2023/03/23	05:13:54
-----------------	----	--------------	------------	----------

BOARD TO BOARD (BTB) DISTANCE

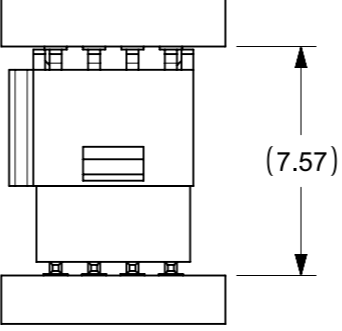
HEADER	MATES WITH (RECEPTACLE)	BTB DIST.	PICTORIAL VIEW
87933	78120	7.57	

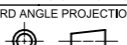
THIS DRAWING CONTAINS INFORMATION THAT IS PROPRIETARY TO MOLEX ELECTRONIC TECHNOLOGIES, LLC AND SHOULD NOT BE USED WITHOUT WRITTEN PERMISSION											
DIMENSION UNITS	SCALE	CURRENT REV DESC:									
mm	NTS										
GENERAL TOLERANCES (UNLESS SPECIFIED)		EC NO: 743277 DRWN: DANUSA 2022/11/18 CHK'D: SUAIFR 2023/03/22 APPR: MRAMAKRISHNA 2023/03/23				1.27MM PITCH SMT HEADER WITH CAP PACKED IN TUBE					
ANGULAR TOL	± 3.0 °					PRODUCT CUSTOMER DRAWING					
4 PLACES	±					INITIAL REVISION:		DOCUMENT NUMBER	DOC TYPE	DOC PART	REVISION
3 PLACES	±					DRWN: SCHEONG 2016/09/14	2016/11/10	SD-87933-0001	PSD	000	C5
2 PLACES	± 0.2					APPR: SCHEONG 2016/11/10					
1 PLACE	±	THIRD ANGLE PROJECTION		DRAWING	SERIES	MATERIAL NUMBER	CUSTOMER	SHEET NUMBER			
0 PLACES	±			A3-SIZE	87933	SEE TABLE	GENERAL MARKET	6 OF 6			
DRAFT WHERE APPLICABLE MUST REMAIN WITHIN DIMENSIONS											

DOCUMENT STATUS	P1	RELEASE DATE	2023/03/23 05:13:54
-----------------	----	--------------	---------------------