

# 14-Bit, 125MSPS/105MSPS/ 80MSPS Low Power Octal ADCs

## FEATURES

- **8-Channel Simultaneous Sampling ADC**
- **73.1dB SNR**
- **88dB SFDR**
- Low Power: 140mW/113mW/94mW per Channel
- Single 1.8V Supply
- Serial LVDS Outputs: 1 or 2 Bits per Channel
- Selectable Input Ranges: 1V<sub>P-P</sub> to 2V<sub>P-P</sub>
- 800MHz Full Power Bandwidth S/H
- Shutdown and Nap Modes
- Serial SPI Port for Configuration
- Internal Bypass Capacitance, No External Components
- 140-Pin (11.25mm × 9mm) BGA Package

## APPLICATIONS

- Communications
- Cellular Base Stations
- Software Defined Radios
- Portable Medical Imaging
- Multichannel Data Acquisition
- Nondestructive Testing

## DESCRIPTION

The LTM<sup>®</sup>9011-14/LTM9010-14/LTM9009-14 are 8-channel, simultaneous sampling 14-bit A/D converters designed for digitizing high frequency, wide dynamic range signals. AC performance includes 73.1dB SNR and 88dB spurious free dynamic range (SFDR). Low power consumption per channel reduces heat in high channel count applications. Integrated bypass capacitance and flow-through pinout reduces overall board space requirements.

DC specs include ±1LSB INL (typ), ±0.3LSB DNL (typ) and no missing codes over temperature. The transition noise is a low 1.2LSB<sub>RMS</sub>.

The digital outputs are serial LVDS to minimize the number of data lines. Each channel outputs two bits at a time (2-lane mode). At lower sampling rates there is a one bit per channel option (1-lane mode).

The ENC<sup>+</sup> and ENC<sup>-</sup> inputs may be driven differentially or single-ended with a sine wave, PECL, LVDS, TTL, or CMOS inputs. An internal clock duty cycle stabilizer allows high performance at full speed for a wide range of clock duty cycles.

All registered trademarks and trademarks are the property of their respective owners.

## TYPICAL APPLICATION

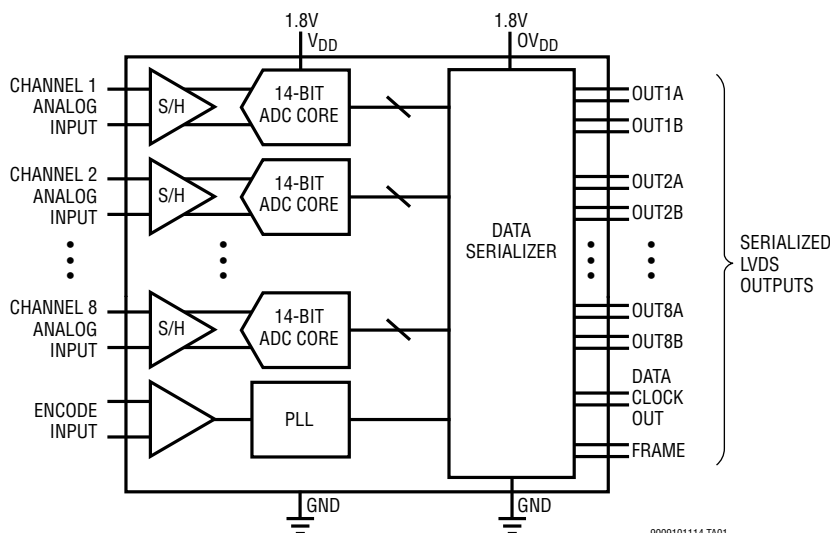

LTM9011-14, 125MSPS,  
2-Tone FFT,  $f_{IN} = 70\text{MHz}$  and  $75\text{MHz}$

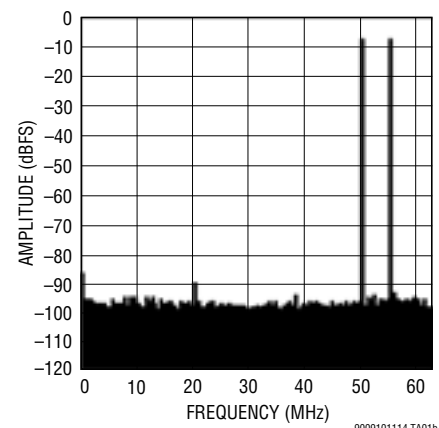

# LTM9011-14/ LTM9010-14/LTM9009-14

## ABSOLUTE MAXIMUM RATINGS

(Notes 1, 2)

Supply Voltages

$V_{DD}$ ,  $OV_{DD}$ ..... -0.3V to 2V

Analog Input Voltage ( $A_{IN}^+$ ,  $A_{IN}^-$ ,

$\overline{PAR/SER}$ ,  $\overline{SENSE}$ ) (Note 3)..... -0.3V to ( $V_{DD} + 0.2V$ )

Digital Input Voltage ( $\overline{ENC}^+$ ,  $\overline{ENC}^-$ ,  $\overline{CS}$ ,

$\overline{SDI}$ ,  $\overline{SCK}$ ) (Note 4) ..... -0.3V to 3.9V

$\overline{SDO}$  (Note 4)..... -0.3V to 3.9V

Digital Output Voltage ..... -0.3V to ( $OV_{DD} + 0.3V$ )

Operating Temperature Range

LTM9011C, LTM9010C, LTM9009C ..... 0°C to 70°C

LTM9011I, LTM9010I, LTM9009I ..... -40°C to 85°C

Storage Temperature Range ..... -55°C to 125°C

## PIN CONFIGURATION

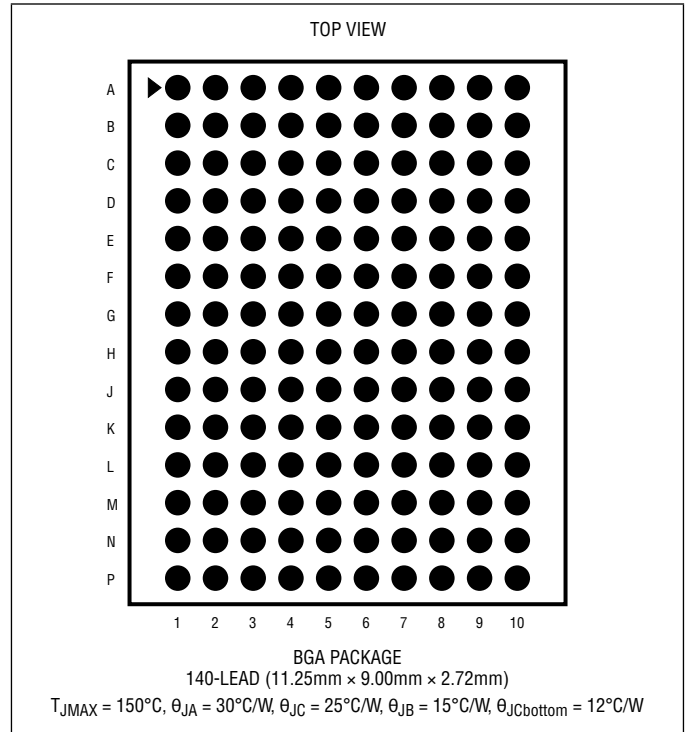

## ORDER INFORMATION <http://www.linear.com/product/LTM9011-14#orderinfo>

| LEAD FREE FINISH | TRAY             | PART MARKING* | PACKAGE DESCRIPTION                   | TEMPERATURE RANGE |
|------------------|------------------|---------------|---------------------------------------|-------------------|
| LTM9011CY-14#PBF | LTM9011CY-14#PBF | LTM9011Y14    | 140-Lead (11.25mm × 9mm × 2.72mm) BGA | 0°C to 70°C       |
| LTM9011IY-14#PBF | LTM9011IY-14#PBF | LTM9011Y14    | 140-Lead (11.25mm × 9mm × 2.72mm) BGA | -40°C to 85°C     |
| LTM9010CY-14#PBF | LTM9010CY-14#PBF | LTM9010Y14    | 140-Lead (11.25mm × 9mm × 2.72mm) BGA | 0°C to 70°C       |
| LTM9010IY-14#PBF | LTM9010IY-14#PBF | LTM9010Y14    | 140-Lead (11.25mm × 9mm × 2.72mm) BGA | -40°C to 85°C     |
| LTM9009CY-14#PBF | LTM9009CY-14#PBF | LTM9009Y14    | 140-Lead (11.25mm × 9mm × 2.72mm) BGA | 0°C to 70°C       |
| LTM9009IY-14#PBF | LTM9009IY-14#PBF | LTM9009Y14    | 140-Lead (11.25mm × 9mm × 2.72mm) BGA | -40°C to 85°C     |

Consult LTC Marketing for parts specified with wider operating temperature ranges. \*The temperature grade is identified by a label on the shipping container.

For more information on lead free part marking, go to: <http://www.linear.com/leadfree/>

For more information on tape and reel specifications, go to: <http://www.linear.com/tapeandreel/>. Some packages are available in 500 unit reels through designated sales channels with #TRMPBF suffix.

**CONVERTER CHARACTERISTICS** The ● denotes the specifications which apply over the full operating temperature range, otherwise specifications are at  $T_A = 25^\circ\text{C}$ . (Note 5)

| PARAMETER                     | CONDITIONS                               | LTM9011-14 |      |            | LTM9010-14 |       |            | LTM9009-14 |       |            | UNITS |                    |
|-------------------------------|--|------------|------|------------|------------|-------|------------|------------|-------|------------|-------|--------------------|
|                               |  | MIN        | TYP  | MAX        | MIN        | TYP   | MAX        | MIN        | TYP   | MAX        |       |                    |
| Resolution (No Missing Codes) |  | ●          | 14   |            | 14         |       | 14         |            | 14    |            | Bits  |                    |
| Integral Linearity Error      | Differential Analog Input (Note 6)       | ●          | -4.1 | ±1.2       | 4.1        | -3.25 | ±1         | 3.25       | -2.75 | ±1         | 2.75  | LSB                |
| Differential Linearity Error  | Differential Analog Input                | ●          | -0.9 | ±0.3       | 0.9        | -0.8  | ±0.3       | 0.8        | -0.8  | ±0.3       | 0.8   | LSB                |
| Offset Error                  | (Note 7)                                 | ●          | -12  | ±3         | 12         | -12   | ±3         | 12         | -12   | ±3         | 12    | mV                 |
| Gain Error                    | Internal Reference<br>External Reference | ●          |      | -1.3       |            |       | -1.3       |            |       | -1.3       |       | %FS<br>%FS         |
| Offset Drift                  |  |            |      | ±20        |            |       | ±20        |            |       | ±20        |       | μV/°C              |
| Full-Scale Drift              | Internal Reference<br>External Reference |            |      | ±35<br>±25 |            |       | ±35<br>±25 |            |       | ±35<br>±25 |       | ppm/°C<br>ppm/°C   |
| Gain Matching                 | External Reference                       |            |      | ±0.2       |            |       | ±0.2       |            |       | ±0.2       |       | %FS                |
| Offset Matching               |  |            |      | ±3         |            |       | ±3         |            |       | ±3         |       | mV                 |
| Transition Noise              | External Reference                       |            |      | 1.2        |            |       | 1.2        |            |       | 1.2        |       | LSB <sub>RMS</sub> |

**ANALOG INPUT** The ● denotes the specifications which apply over the full operating temperature range, otherwise specifications are at  $T_A = 25^\circ\text{C}$ . (Note 5)

| SYMBOL       | PARAMETER  | CONDITIONS  | MIN | TYP               | MAX      | UNITS            |                   |
|--------------|--|---|-----|-------------------|----------|------------------|-------------------|
| $V_{IN}$     | Analog Input Range ( $A_{IN}^+ - A_{IN}^-$ )         | $1.7V < V_{DD} < 1.9V$                                  | ●   | 1 to 2            |          | $V_{P-P}$        |                   |
| $V_{IN(CM)}$ | Analog Input Common Mode ( $A_{IN}^+ + A_{IN}^-$ )/2 | Differential Analog Input (Note 8)                      | ●   | $V_{CM} - 100mV$  | $V_{CM}$ | $V_{CM} + 100mV$ | V                 |
| $V_{SENSE}$  | External Voltage Reference Applied to SENSE          | External Reference Mode                                 | ●   | 0.625             | 1.250    | 1.300            | V                 |
| $I_{INCM}$   | Analog Input Common Mode Current                     | Per Pin, 125Msps<br>Per Pin, 105Msps<br>Per Pin, 80Msps |     | 155<br>130<br>100 |          |                  | μA<br>μA<br>μA    |
| $I_{IN1}$    | Analog Input Leakage Current                         | $0 < A_{IN}^+, A_{IN}^- < V_{DD}$ , No Encode           | ●   | -1                | 1        |                  | μA                |
| $I_{IN2}$    | PAR/SER Input Leakage Current                        | $0 < PAR/SER < V_{DD}$                                  | ●   | -3                | 3        |                  | μA                |
| $I_{IN3}$    | SENSE Input Leakage Current                          | $0.625 < SENSE < 1.3V$                                  | ●   | -6                | 6        |                  | μA                |
| $t_{AP}$     | Sample-and-Hold Acquisition Delay Time               |   |     | 0                 |          |                  | ns                |
| $t_{JITTER}$ | Sample-and-Hold Acquisition Delay Jitter             |   |     | 0.15              |          |                  | ps <sub>RMS</sub> |
| CMRR         | Analog Input Common Mode Rejection Ratio             |   |     | 80                |          |                  | dB                |
| BW-3B        | Full-Power Bandwidth                                 | Figure 6 Test Circuit                                   |     | 800               |          |                  | MHz               |

# LTM9011-14/ LTM9010-14/LTM9009-14

**DYNAMIC ACCURACY** The ● denotes the specifications which apply over the full operating temperature range, otherwise specifications are at  $T_A = 25^\circ\text{C}$ .  $A_{IN} = -1\text{dBFS}$ . (Note 5)

| SYMBOL       | PARAMETER   | CONDITIONS            | LTM9011-14 |      |      | LTM9010-14 |      |      | LTM9009-14 |      |      | UNITS |
|--------------|---|-----------------------|------------|------|------|------------|------|------|------------|------|------|-------|
|              |   |                       | MIN        | TYP  | MAX  | MIN        | TYP  | MAX  | MIN        | TYP  | MAX  |       |
| SNR          | Signal-to-Noise Ratio                                 | 5MHz Input            |            | 73.1 |      |            | 73   |      |            | 73   |      | dBFS  |
|              |   | 70MHz Input           | ●          | 70.8 | 73   |            | 70.6 | 72.9 |            | 69.7 | 72.9 | dBFS  |
|              |   | 140MHz Input          |            |      | 72.6 |            |      | 72.6 |            |      | 72.5 | dBFS  |
| SFDR         | Spurious Free Dynamic Range<br>2nd or 3rd Harmonic    | 5MHz Input            |            | 88   |      |            | 88   |      |            | 88   |      | dBFS  |
|              |   | 70MHz Input           | ●          | 69   | 85   |            | 71   | 85   |            | 74   | 85   | dBFS  |
|              |   | 140MHz Input          |            |      | 82   |            |      | 82   |            |      | 82   | dBFS  |
|              | Spurious Free Dynamic Range<br>4th Harmonic or Higher | 5MHz Input            |            | 81   | 90   |            | 81   | 90   |            | 82   | 90   | dBFS  |
| 70MHz Input  |   | ●                     |            | 90   |      |            | 90   |      |            | 90   | dBFS |       |
| 140MHz Input |   |                       |            | 90   |      |            | 90   |      |            | 90   | dBFS |       |
| S/(N+D)      | Signal-to-Noise Plus<br>Distortion Ratio              | 5MHz Input            |            | 73   |      |            | 73   |      |            | 72.9 |      | dBFS  |
|              |   | 70MHz Input           | ●          | 68.4 | 72.6 |            | 69.7 | 72.6 |            | 69.6 | 72.6 | dBFS  |
|              |   | 140MHz Input          |            |      | 72   |            |      | 72   |            |      | 72   | dBFS  |
|              | Crosstalk, Near Channel                               | 10MHz Input (Note 12) |            | -90  |      |            | -90  |      |            | -90  |      | dBc   |
|              | Crosstalk, Far Channel                                | 10MHz Input (Note 12) |            | -105 |      |            | -105 |      |            | -105 |      | dBc   |

**INTERNAL REFERENCE CHARACTERISTICS** The ● denotes the specifications which apply over the full operating temperature range, otherwise specifications are at  $T_A = 25^\circ\text{C}$ .  $A_{IN} = -1\text{dBFS}$ . (Note 5)

| PARAMETER                          | CONDITIONS                               | MIN                              | TYP                | MAX                              | UNITS                 |
|------------------------------------|--|----------------------------------|--------------------|----------------------------------|-----------------------|
| $V_{CM}$ Output Voltage            | $I_{OUT} = 0$                            | $0.5 \cdot V_{DD} - 25\text{mV}$ | $0.5 \cdot V_{DD}$ | $0.5 \cdot V_{DD} + 25\text{mV}$ | V                     |
| $V_{CM}$ Output Temperature Drift  |  |                                  | $\pm 25$           |                                  | ppm/ $^\circ\text{C}$ |
| $V_{CM}$ Output Resistance         | $-600\mu\text{A} < I_{OUT} < 1\text{mA}$ |                                  | 4                  |                                  | $\Omega$              |
| $V_{REF}$ Output Voltage           | $I_{OUT} = 0$                            | 1.225                            | 1.250              | 1.275                            | V                     |
| $V_{REF}$ Output Temperature Drift |  |                                  | $\pm 25$           |                                  | ppm/ $^\circ\text{C}$ |
| $V_{REF}$ Output Resistance        | $-400\mu\text{A} < I_{OUT} < 1\text{mA}$ |                                  | 7                  |                                  | $\Omega$              |
| $V_{REF}$ Line Regulation          | $1.7\text{V} < V_{DD} < 1.9\text{V}$     |                                  | 0.6                |                                  | mV/V                  |

**DIGITAL INPUTS AND OUTPUTS** The ● denotes the specifications which apply over the full operating temperature range, otherwise specifications are at  $T_A = 25^\circ\text{C}$ . (Note 5)

| SYMBOL  | PARAMETER                          | CONDITIONS  |        | MIN            | TYP            | MAX            | UNITS    |
|---|------------------------------------|---|--------|----------------|----------------|----------------|----------|
| <b>ENCODE INPUTS (ENC<sup>+</sup>, ENC<sup>-</sup>)</b>   |                                    |   |        |                |                |                |          |
| <b>Differential Encode Mode (ENC<sup>-</sup> Not Tied to GND)</b>   |                                    |   |        |                |                |                |          |
| V <sub>ID</sub>   | Differential Input Voltage         | (Note 8)  | ●      | 0.2            |                |                | V        |
| V <sub>ICM</sub>  | Common Mode Input Voltage          | Internally Set<br>Externally Set (Note 8)                                 | ●      | 1.1            | 1.2            | 1.6            | V<br>V   |
| V <sub>IN</sub>   | Input Voltage Range                | ENC <sup>+</sup> , ENC <sup>-</sup> to GND                                | ●      | 0.2            |                | 3.6            | V        |
| R <sub>IN</sub>   | Input Resistance                   | (See Figure 10)   |        |                | 10             |                | kΩ       |
| C <sub>IN</sub>   | Input Capacitance                  |   |        |                | 3.5            |                | pF       |
| <b>Single-Ended Encode Mode (ENC<sup>-</sup> Tied to GND)</b>   |                                    |   |        |                |                |                |          |
| V <sub>IH</sub>   | High Level Input Voltage           | V <sub>DD</sub> = 1.8V  | ●      | 1.2            |                |                | V        |
| V <sub>IL</sub>   | Low Level Input Voltage            | V <sub>DD</sub> = 1.8V  | ●      |                |                | 0.6            | V        |
| V <sub>IN</sub>   | Input Voltage Range                | ENC <sup>+</sup> to GND   | ●      | 0              |                | 3.6            | V        |
| R <sub>IN</sub>   | Input Resistance                   | (See Figure 11)   |        |                | 30             |                | kΩ       |
| C <sub>IN</sub>   | Input Capacitance                  |   |        |                | 3.5            |                | pF       |
| <b>DIGITAL INPUTS (CS, SDI, SCK in Serial or Parallel Programming Mode. SDO in Parallel Programming Mode)</b> |                                    |   |        |                |                |                |          |
| V <sub>IH</sub>   | High Level Input Voltage           | V <sub>DD</sub> = 1.8V  | ●      | 1.3            |                |                | V        |
| V <sub>IL</sub>   | Low Level Input Voltage            | V <sub>DD</sub> = 1.8V  | ●      |                |                | 0.6            | V        |
| I <sub>IN</sub>   | Input Current                      | V <sub>IN</sub> = 0V to 3.6V  | ●      | -10            |                | 10             | μA       |
| C <sub>IN</sub>   | Input Capacitance                  |   |        |                | 3              |                | pF       |
| <b>SDO OUTPUT (Serial Programming Mode. Open-Drain Output. Requires 2kΩ Pull-Up Resistor if SDO Is Used)</b>  |                                    |   |        |                |                |                |          |
| R <sub>OL</sub>   | Logic Low Output Resistance to GND | V <sub>DD</sub> = 1.8V, SDO = 0V  |        |                | 200            |                | Ω        |
| I <sub>OH</sub>   | Logic High Output Leakage Current  | SDO = 0V to 3.6V  | ●      | -10            |                | 10             | μA       |
| C <sub>OUT</sub>  | Output Capacitance                 |   |        |                | 3              |                | pF       |
| <b>DIGITAL DATA OUTPUTS</b>   |                                    |   |        |                |                |                |          |
| V <sub>OD</sub>   | Differential Output Voltage        | 100Ω Differential Load, 3.5mA Mode<br>100Ω Differential Load, 1.75mA Mode | ●<br>● | 247<br>125     | 350<br>175     | 454<br>250     | mV<br>mV |
| V <sub>OS</sub>   | Common Mode Output Voltage         | 100Ω Differential Load, 3.5mA Mode<br>100Ω Differential Load, 1.75mA Mode | ●<br>● | 1.125<br>1.125 | 1.250<br>1.250 | 1.375<br>1.375 | V<br>V   |
| R <sub>TERM</sub>   | On-Chip Termination Resistance     | Termination Enabled, 0V <sub>DD</sub> = 1.8V                              |        |                | 100            |                | Ω        |

# LTM9011-14/ LTM9010-14/LTM9009-14

## POWER REQUIREMENTS

The ● denotes the specifications which apply over the full operating temperature range, otherwise specifications are at  $T_A = 25^\circ\text{C}$ . (Note 9)

| SYMBOL        | PARAMETER   | CONDITIONS               | LTM9011-14 |      |      | LTM9010-14 |      |      | LTM9009-14 |     |     | UNITS |    |
|---------------|---|--------------------------|------------|------|------|------------|------|------|------------|-----|-----|-------|----|
|               |   |                          | MIN        | TYP  | MAX  | MIN        | TYP  | MAX  | MIN        | TYP | MAX |       |    |
| $V_{DD}$      | Analog Supply Voltage   | (Note 10)                | ●          | 1.7  | 1.8  | 1.9        | 1.7  | 1.8  | 1.9        | 1.7 | 1.8 | 1.9   | V  |
| $OV_{DD}$     | Output Supply Voltage   | (Note 10)                | ●          | 1.7  | 1.8  | 1.9        | 1.7  | 1.8  | 1.9        | 1.7 | 1.8 | 1.9   | V  |
| $I_{VDD}$     | Analog Supply Current   | Sine Wave Input          | ●          | 582  | 632  |            | 476  | 508  |            | 395 | 450 |       | mA |
| $I_{OVDD}$    | Digital Supply Current  | 2-Lane Mode, 1.75mA Mode | ●          | 54   | 62   |            | 52   | 62   |            | 50  | 58  |       | mA |
|               |   | 2-Lane Mode, 3.5mA Mode  | ●          | 98   | 108  |            | 96   | 106  |            | 94  | 104 |       | mA |
| $P_{DISS}$    | Power Dissipation   | 2-Lane Mode, 1.75mA Mode | ●          | 1145 | 1249 |            | 950  | 1026 |            | 801 | 914 |       | mW |
|               |   | 2-Lane Mode, 3.5mA Mode  | ●          | 1224 | 1332 |            | 1030 | 1105 |            | 880 | 997 |       | mW |
| $P_{SLEEP}$   | Sleep Mode Power  |                          |            | 2    |      |            | 2    |      |            | 2   |     | mW    |    |
| $P_{NAP}$     | Nap Mode Power  |                          |            | 170  |      |            | 170  |      |            | 170 |     | mW    |    |
| $P_{DIFFCLK}$ | Power Decrease With Single-Ended Encode Mode Enabled (No Decrease for Sleep Mode) |                          |            | 40   |      |            | 40   |      |            | 40  |     | mW    |    |

## TIMING CHARACTERISTICS

The ● denotes the specifications which apply over the full operating temperature range, otherwise specifications are at  $T_A = 25^\circ\text{C}$ . (Note 5)

| SYMBOL     | PARAMETER                              | CONDITIONS                | LTM9011-14 |     |     | LTM9010-14 |      |      | LTM9009-14 |      |      | UNITS |    |
|------------|--|---------------------------|------------|-----|-----|------------|------|------|------------|------|------|-------|----|
|            |  |                           | MIN        | TYP | MAX | MIN        | TYP  | MAX  | MIN        | TYP  | MAX  |       |    |
| $f_S$      | Sampling Frequency                     | (Notes 10,11)             | ●          | 5   | 125 | 5          | 105  | 5    | 80         |      | MHz  |       |    |
| $t_{ENCL}$ | ENC Low Time (Note 8)                  | Duty Cycle Stabilizer Off | ●          | 3.8 | 4   | 100        | 4.52 | 4.76 | 100        | 5.93 | 6.25 | 100   | ns |
|            |  | Duty Cycle Stabilizer On  | ●          | 2   | 4   | 100        | 2    | 4.76 | 100        | 2    | 6.25 | 100   | ns |
| $t_{ENCH}$ | ENC High Time (Note 8)                 | Duty Cycle Stabilizer Off | ●          | 3.8 | 4   | 100        | 4.52 | 4.76 | 100        | 5.93 | 6.25 | 100   | ns |
|            |  | Duty Cycle Stabilizer On  | ●          | 2   | 4   | 100        | 2    | 4.76 | 100        | 2    | 6.25 | 100   | ns |
| $t_{AP}$   | Sample-and-Hold Acquisition Delay Time |                           |            | 0   |     |            | 0    |      |            | 0    |      | ns    |    |

| SYMBOL  | PARAMETER              | CONDITIONS                    | MIN | TYP                      | MAX                      | UNITS                    |   |
|---|------------------------|-------------------------------|-----|--------------------------|--------------------------|--------------------------|---|
| <b>Digital Data Outputs (<math>R_{TERM} = 100\Omega</math> Differential, <math>C_L = 2\text{pF}</math> to GND on Each Output)</b> |                        |                               |     |                          |                          |                          |   |
| $t_{SER}$   | Serial Data Bit Period | 2-Lanes, 16-Bit Serialization |     | $1/(8 \cdot f_S)$        |                          | s                        |   |
|   |                        | 2-Lanes, 14-Bit Serialization |     | $1/(7 \cdot f_S)$        |                          | s                        |   |
|   |                        | 2-Lanes, 12-Bit Serialization |     | $1/(6 \cdot f_S)$        |                          | s                        |   |
|   |                        | 1-Lane, 16-Bit Serialization  |     | $1/(16 \cdot f_S)$       |                          | s                        |   |
|   |                        | 1-Lane, 14-Bit Serialization  |     | $1/(14 \cdot f_S)$       |                          | s                        |   |
|   |                        | 1-Lane, 12-Bit Serialization  |     | $1/(12 \cdot f_S)$       |                          | s                        |   |
| $t_{FRAME}$   | FR to DCO Delay        | (Note 8)                      | ●   | $0.35 \cdot t_{SER}$     | $0.5 \cdot t_{SER}$      | $0.65 \cdot t_{SER}$     | s |
| $t_{DATA}$  | DATA to DCO Delay      | (Note 8)                      | ●   | $0.35 \cdot t_{SER}$     | $0.5 \cdot t_{SER}$      | $0.65 \cdot t_{SER}$     | s |
| $t_{PD}$  | Propagation Delay      | (Note 8)                      | ●   | $0.7n + 2 \cdot t_{SER}$ | $1.1n + 2 \cdot t_{SER}$ | $1.5n + 2 \cdot t_{SER}$ | s |
| $t_R$   | Output Rise Time       | Data, DCO, FR, 20% to 80%     |     | 0.17                     |                          | ns                       |   |
| $t_F$   | Output Fall Time       | Data, DCO, FR, 20% to 80%     |     | 0.17                     |                          | ns                       |   |
|   | DCO Cycle-Cycle Jitter | $t_{SER} = 1\text{ns}$        |     | 60                       |                          | psp-p                    |   |
|   | Pipeline Latency       |                               |     | 6                        |                          | Cycles                   |   |

**TIMING CHARACTERISTICS** The ● denotes the specifications which apply over the full operating temperature range, otherwise specifications are at  $T_A = 25^\circ\text{C}$ . (Note 5)

| SYMBOL                          | PARAMETER                                | CONDITIONS  | MIN    | TYP       | MAX | UNITS    |
|---------------------------------|--|---|--------|-----------|-----|----------|
| <b>SPI Port Timing (Note 8)</b> |  |   |        |           |     |          |
| $t_{\text{SCK}}$                | SCK Period                               | Write Mode<br>Read Back Mode, $C_{\text{SDO}} = 20\text{pF}$ ,<br>$R_{\text{PULLUP}} = 2\text{k}$ | ●<br>● | 40<br>250 |     | ns<br>ns |
| $t_{\text{S}}$                  | $\overline{\text{CS}}$ to SCK Setup Time |   | ●      | 5         |     | ns       |
| $t_{\text{H}}$                  | SCK to $\overline{\text{CS}}$ Setup Time |   | ●      | 5         |     | ns       |
| $t_{\text{DS}}$                 | SDI Setup Time                           |   | ●      | 5         |     | ns       |
| $t_{\text{DH}}$                 | SDI Hold Time                            |   | ●      | 5         |     | ns       |
| $t_{\text{DO}}$                 | SCK Falling to SDO Valid                 | Read Back Mode, $C_{\text{SDO}} = 20\text{pF}$ ,<br>$R_{\text{PULLUP}} = 2\text{k}$               | ●      |           | 125 | ns       |

**Note 1:** Stresses beyond those listed under Absolute Maximum Ratings may cause permanent damage to the device. Exposure to any Absolute Maximum Rating condition for extended periods may affect device reliability and lifetime.

**Note 2:** All voltage values are with respect to GND (unless otherwise noted).

**Note 3:** When these pin voltages are taken below GND or above  $V_{\text{DD}}$ , they will be clamped by internal diodes. This product can handle input currents of greater than 100mA below GND or above  $V_{\text{DD}}$  without latchup.

**Note 4:** When these pin voltages are taken below GND they will be clamped by internal diodes. When these pin voltages are taken above  $V_{\text{DD}}$  they will not be clamped by internal diodes. This product can handle input currents of greater than 100mA below GND without latchup.

**Note 5:**  $V_{\text{DD}} = \text{OV}_{\text{DD}} = 1.8\text{V}$ ,  $f_{\text{SAMPLE}} = 125\text{MHz}$  (LTM9011), 105MHz (LTM9010), or 80MHz (LTM9009), 2-lane output mode, differential  $\text{ENC}^+/\text{ENC}^- = 2V_{\text{P-P}}$  sine wave, input range =  $2V_{\text{P-P}}$  with differential drive, unless otherwise noted.

**Note 6:** Integral nonlinearity is defined as the deviation of a code from a best fit straight line to the transfer curve. The deviation is measured from the center of the quantization band.

**Note 7:** Offset error is the offset voltage measured from  $-0.5$  LSB when the output code flickers between 00 0000 0000 0000 and 11 1111 1111 1111 in 2's complement output mode.

**Note 8:** Guaranteed by design, not subject to test.

**Note 9:**  $V_{\text{DD}} = \text{OV}_{\text{DD}} = 1.8\text{V}$ ,  $f_{\text{SAMPLE}} = 125\text{MHz}$  (LTM9011), 105MHz (LTM9010), or 80MHz (LTM9009), 2-lane output mode, differential  $\text{ENC}^+/\text{ENC}^- = 2V_{\text{P-P}}$  sine wave, input range =  $2V_{\text{P-P}}$  with differential drive, unless otherwise noted. The supply current and power dissipation specifications are totals for the entire device, not per channel.

**Note 10:** Recommended operating conditions.

**Note 11:** The maximum sampling frequency depends on the speed grade of the part and also which serialization mode is used. The maximum serial data rate is 1000Mbps so  $t_{\text{SER}}$  must be greater than or equal to 1ns.

**Note 12:** Near-channel crosstalk refers to Ch. 1 to Ch.2, and Ch.7 to Ch.8. Far-channel crosstalk refers to Ch.1 to Ch.7, Ch.1 to Ch.8, Ch.2 to Ch.7, and Ch.2 to Ch.8.

## TIMING DIAGRAMS

### 2-Lane Output Mode, 16-Bit Serialization\*

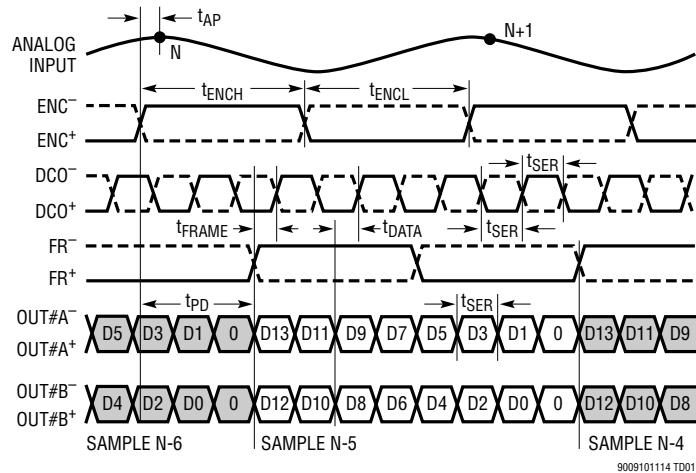

### 2-Lane Output Mode, 14-Bit Serialization

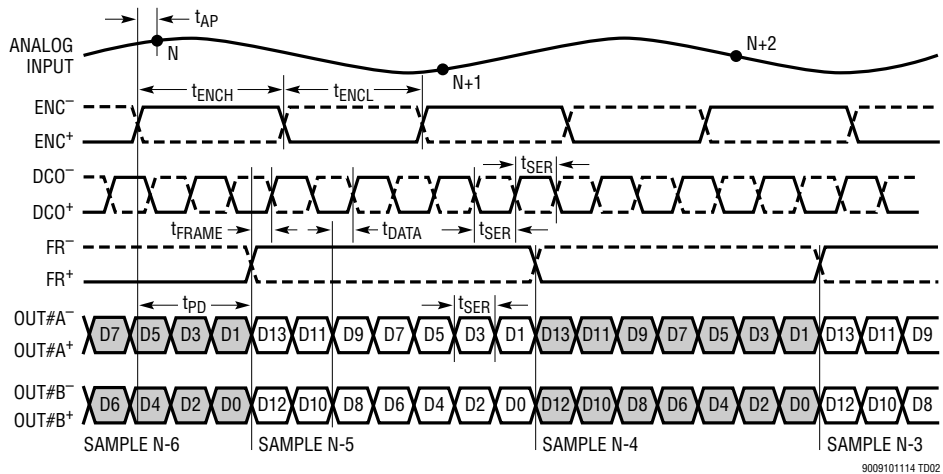



# TIMING DIAGRAMS

## 2-Lane Output Mode, 12-Bit Serialization

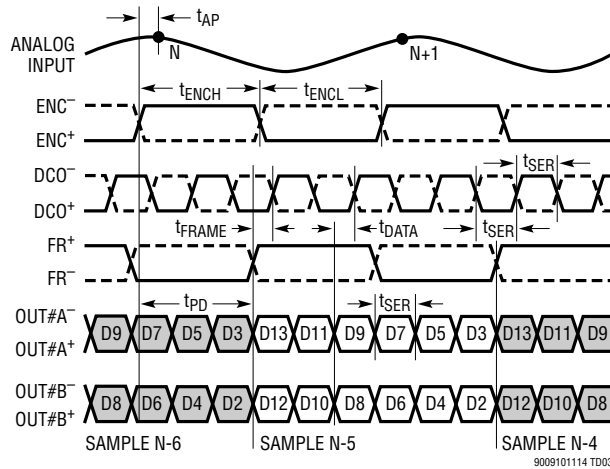

## 1-Lane Output Mode, 16-Bit Serialization

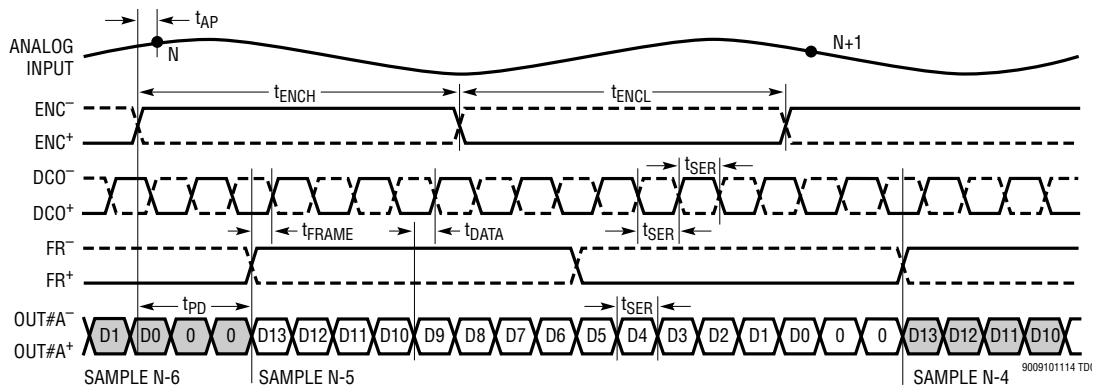

OUT#B<sup>+</sup>, OUT#B<sup>-</sup> ARE DISABLED

## TIMING DIAGRAMS

### 1-Lane Output Mode, 14-Bit Serialization

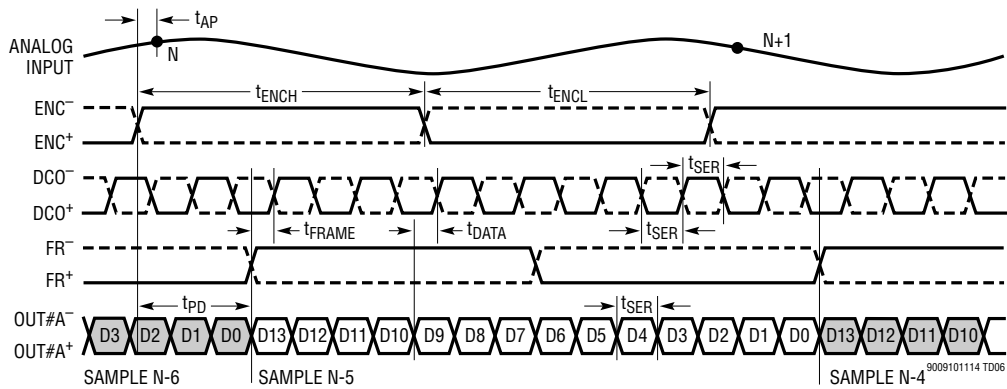

OUT#B<sup>+</sup>, OUT#B<sup>-</sup> ARE DISABLED

### 1-Lane Output Mode, 12-Bit Serialization

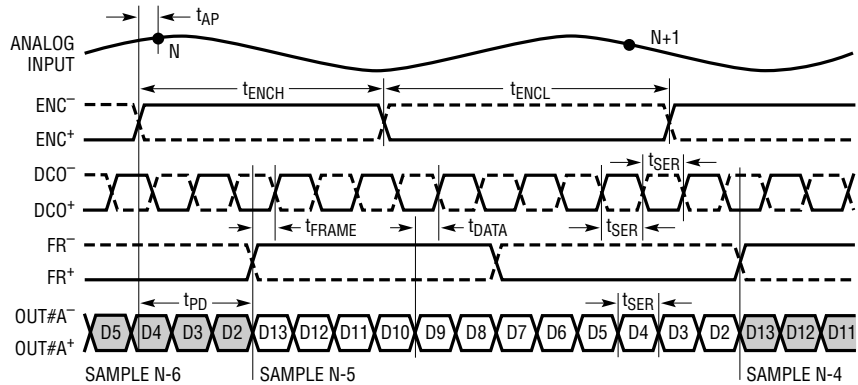

OUT#B<sup>+</sup>, OUT#B<sup>-</sup> ARE DISABLED

## TIMING DIAGRAMS

SPI Port Timing (Readback Mode)

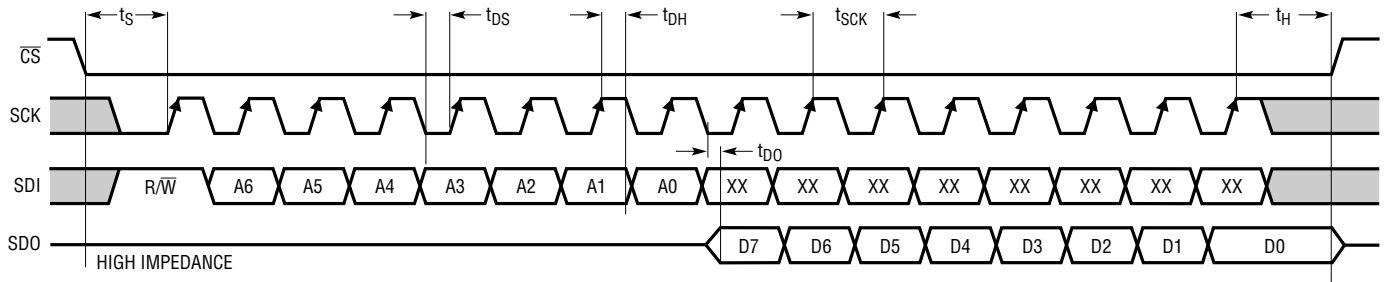

SPI Port Timing (Write Mode)

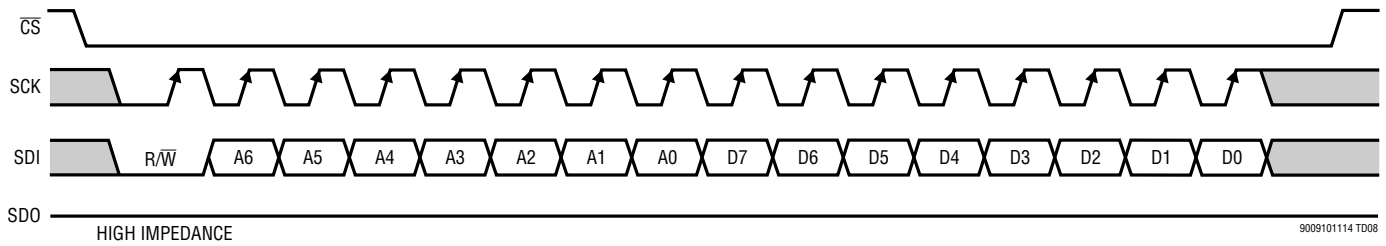

9009101114 T008

## TYPICAL PERFORMANCE CHARACTERISTICS

**LTM9011-14: Integral Nonlinearity (INL)**

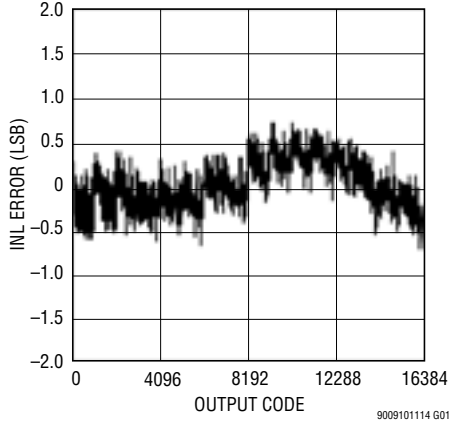

**LTM9011-14: Differential Nonlinearity (DNL)**

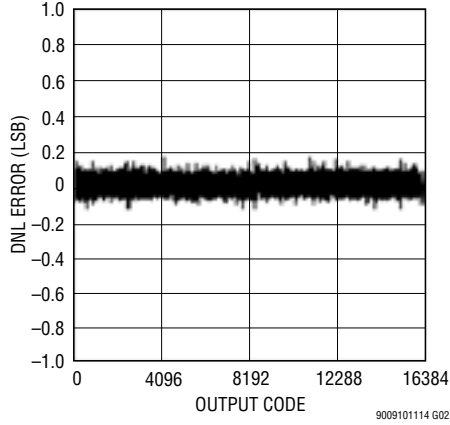

**LTM9011-14: 8k Point FFT,  $f_{IN} = 5\text{MHz}$ , -1dBFS, 125Mpsps**

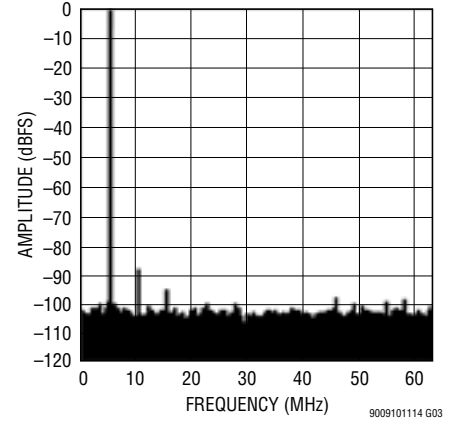

**LTM9011-14: 8k Point FFT,  $f_{IN} = 30\text{MHz}$ , -1dBFS, 125Mpsps**

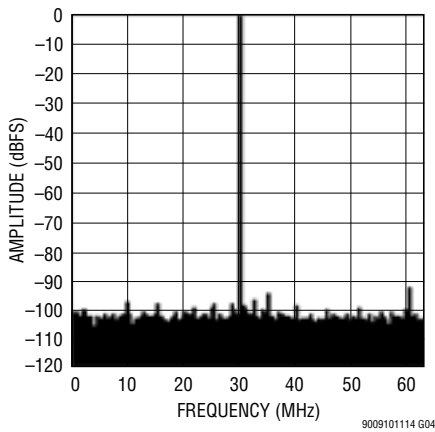

**LTM9011-14: 8k Point FFT,  $f_{IN} = 70\text{MHz}$ , -1dBFS, 125Mpsps**

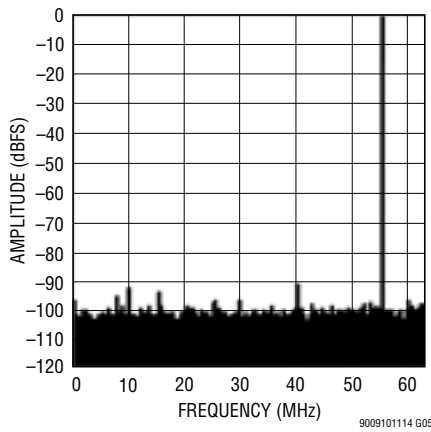

**LTM9011-14: 8k Point FFT,  $f_{IN} = 140\text{MHz}$ , -1dBFS, 125Mpsps**

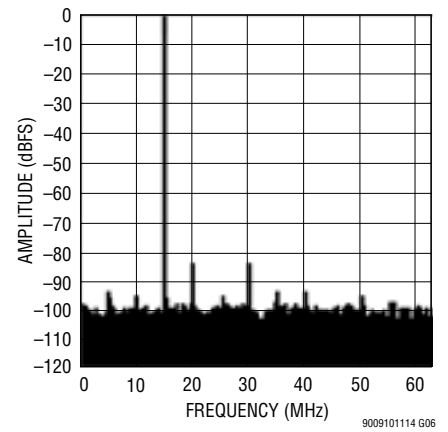

**LTM9011-14: 8k Point 2-Tone FFT,  $f_{IN} = 70\text{MHz}$ , 75MHz, -7dBFS per Tone, 125Mpsps**

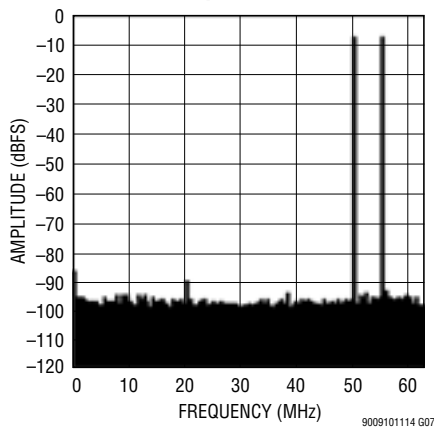

**LTM9011-14: Shorted Input Histogram**

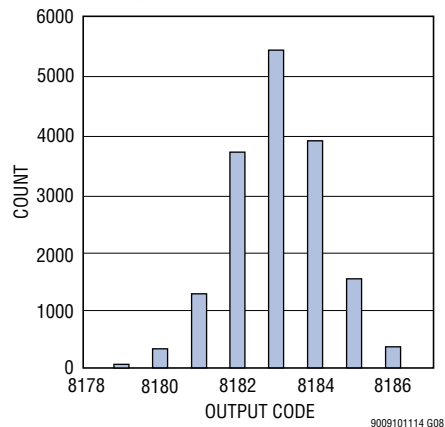

## TYPICAL PERFORMANCE CHARACTERISTICS

**LTM9011-14: SNR vs Input Frequency, -1dBFS, 2V Range, 125Mps**

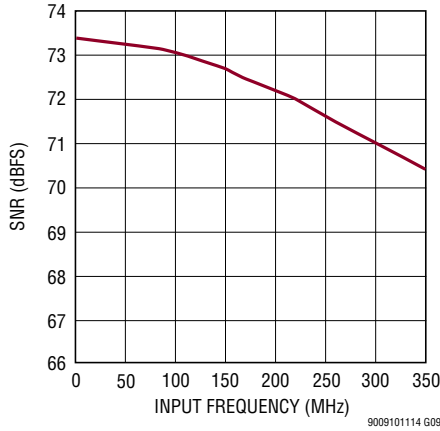

**LTM9011-14: SFDR vs Input Frequency, -1dBFS, 2V Range, 125Mps**

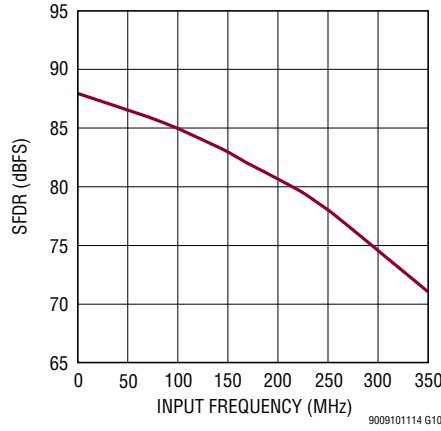

**LTM9011-14: SFDR vs Input Level,  $f_{IN} = 70\text{MHz}$ , 2V Range, 125Mps**

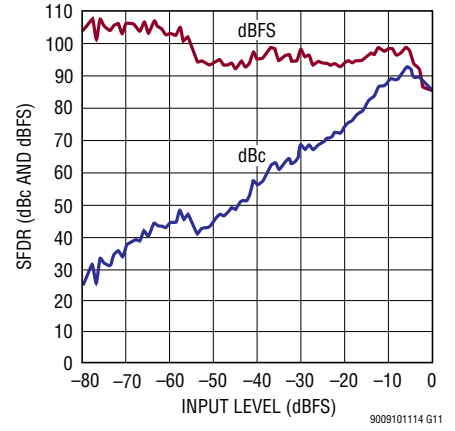

**LTM9011-14: SNR vs Input Level,  $f_{IN} = 70\text{MHz}$ , 2V Range, 125Mps**

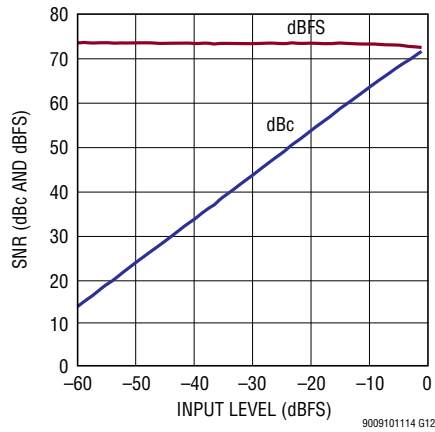

**LTM9011-14:  $I_{VDD}$  vs Sample Rate, 5MHz Sine Wave Input, -1dBFS**

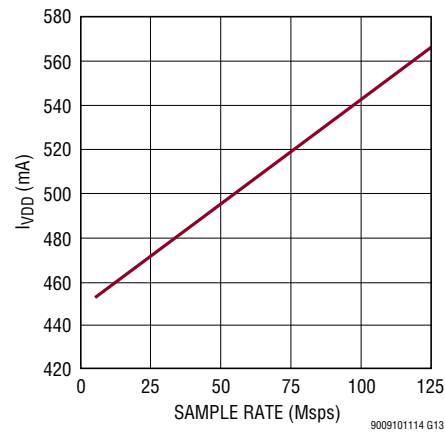

**$I_{VDD}$  vs Sample Rate, 5MHz Sine Wave Input, -1dBFS**

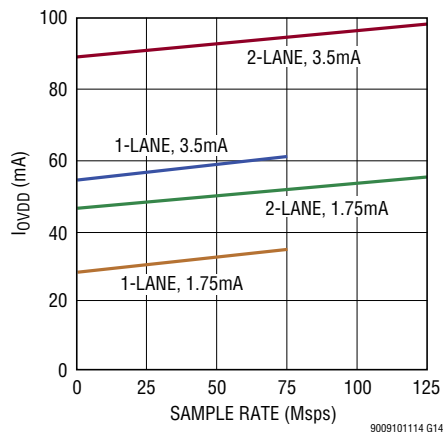

**LTM9011-14: SNR vs SENSE,  $f_{IN} = 5\text{MHz}$ , -1dBFS**

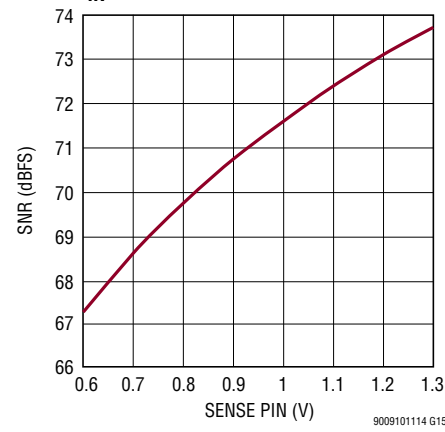

## TYPICAL PERFORMANCE CHARACTERISTICS

**LTM9010-14: Integral Nonlinearity (INL)**

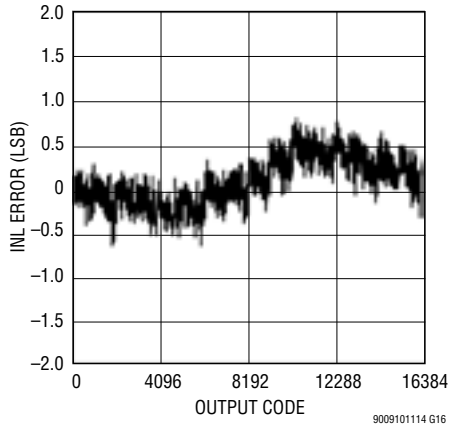

**LTM9010-14: Differential Nonlinearity (DNL)**

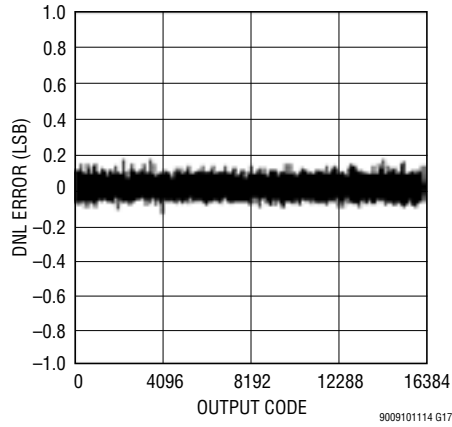

**LTM9010-14: 8k Point FFT,  $f_{IN} = 5\text{MHz}$ ,  $-1\text{dBFS}$ ,  $105\text{Mpsps}$**

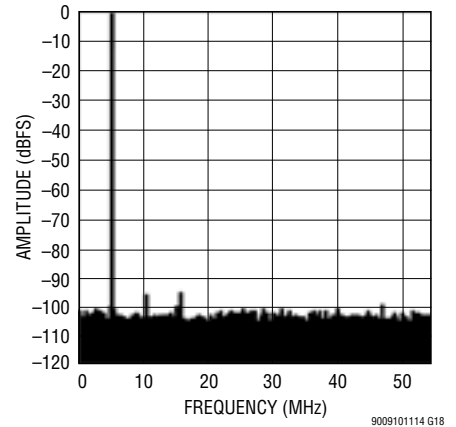

**LTM9010-14: 8k Point FFT,  $f_{IN} = 30\text{MHz}$ ,  $-1\text{dBFS}$ ,  $105\text{Mpsps}$**

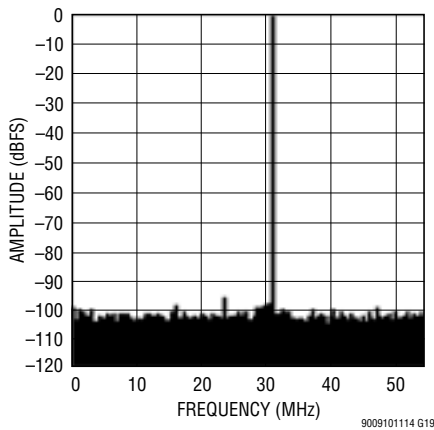

**LTM9010-14: 8k Point FFT,  $f_{IN} = 70\text{MHz}$ ,  $-1\text{dBFS}$ ,  $105\text{Mpsps}$**

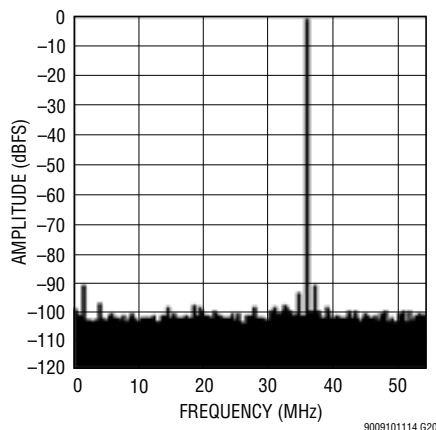

**LTM9010-14: 8k Point FFT,  $f_{IN} = 140\text{MHz}$ ,  $-1\text{dBFS}$ ,  $105\text{Mpsps}$**

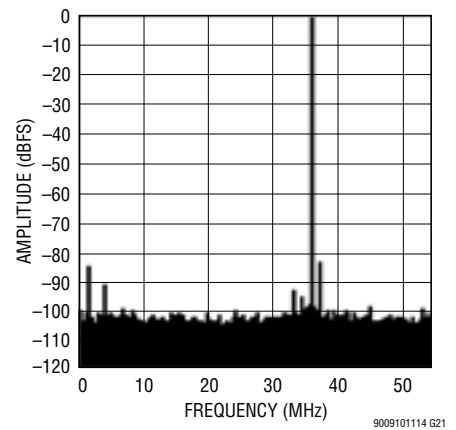

**LTM9010-14: 8k Point 2-Tone FFT,  $f_{IN} = 70\text{MHz}$ ,  $75\text{MHz}$ ,  $-7\text{dBFS}$  per Tone,  $105\text{Mpsps}$**

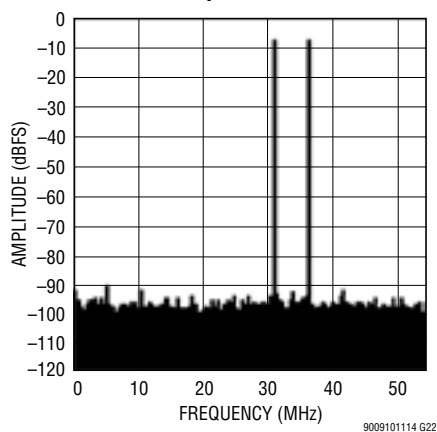

**LTM9010-14: Shorted Input Histogram**

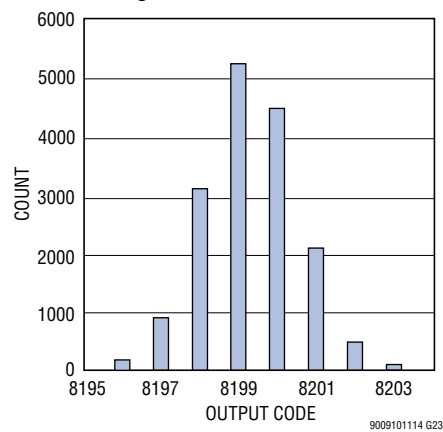

## TYPICAL PERFORMANCE CHARACTERISTICS

**LTM9010-14: SNR vs Input Frequency, -1dBFS, 2V Range, 105Msps**

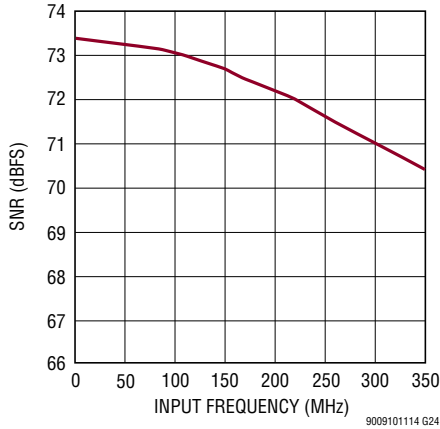

**LTM9010-14: SFDR vs Input Frequency, -1dBFS, 2V Range, 105Msps**

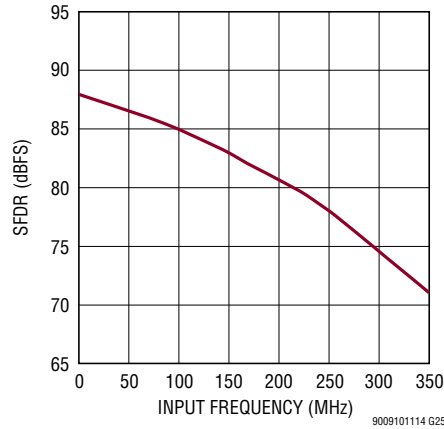

**LTM9010-14: SFDR vs Input Level,  $f_{IN} = 70\text{MHz}$ , 2V Range, 105Msps**

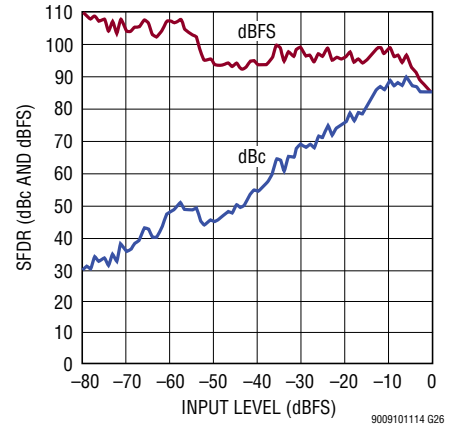

**LTM9010-14:  $I_{VDD}$  vs Sample Rate, 5MHz Sine Wave Input, -1dBFS**

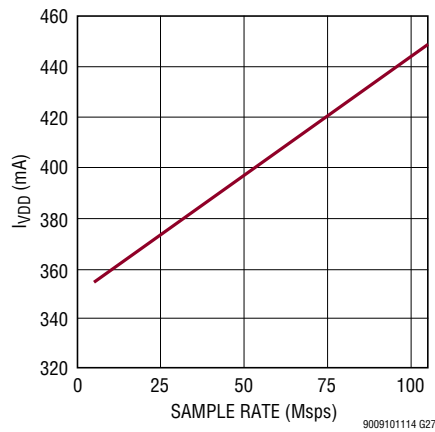

**LTM9010-14: SNR vs SENSE,  $f_{IN} = 5\text{MHz}$ , -1dBFS**

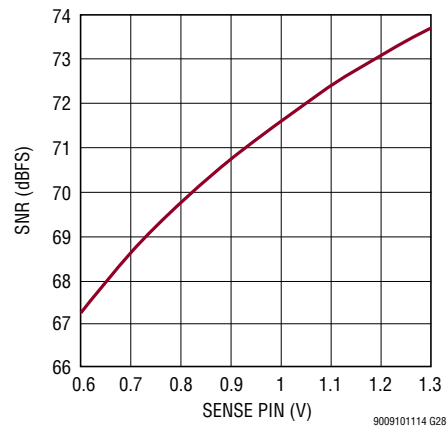

## TYPICAL PERFORMANCE CHARACTERISTICS

**LTM9009-14: Integral Nonlinearity (INL)**

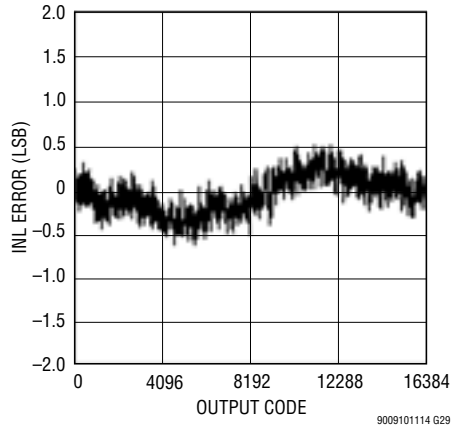

**LTM9009-14: Differential Nonlinearity (DNL)**

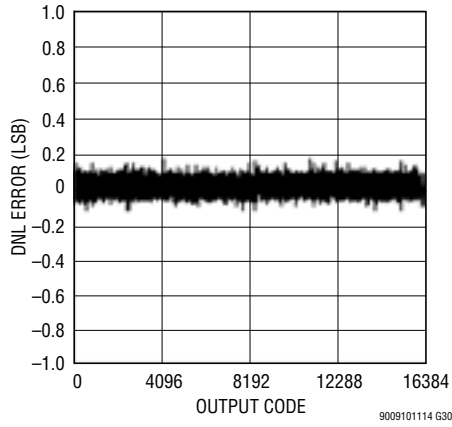

**LTM9009-14: 8k Point FFT,  $f_{IN} = 5\text{MHz}$ ,  $-1\text{dBFS}$ ,  $80\text{Mpsps}$**

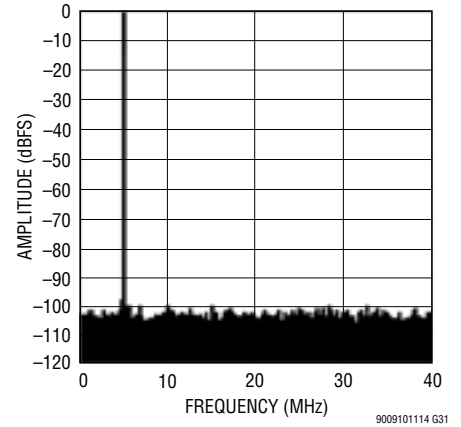

**LTM9009-14: 8k Point FFT,  $f_{IN} = 30\text{MHz}$ ,  $-1\text{dBFS}$ ,  $80\text{Mpsps}$**

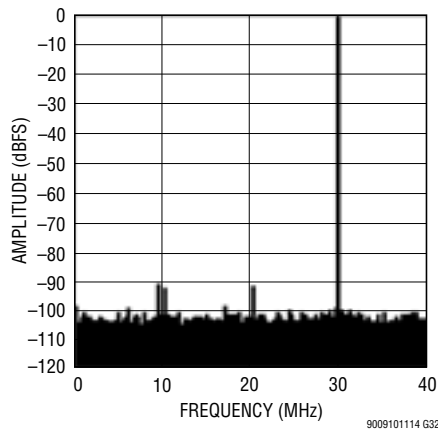

**LTM9009-14: 8k Point FFT,  $f_{IN} = 70\text{MHz}$ ,  $-1\text{dBFS}$ ,  $80\text{Mpsps}$**

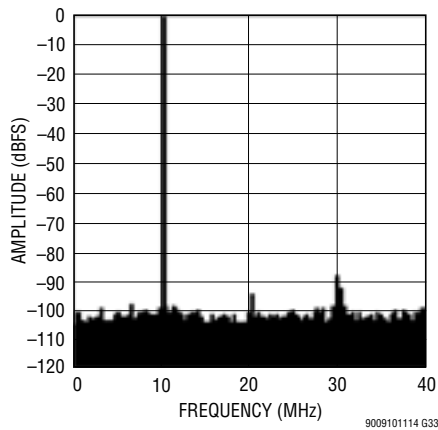

**LTM9009-14: 8k Point FFT,  $f_{IN} = 140\text{MHz}$ ,  $-1\text{dBFS}$ ,  $80\text{Mpsps}$**

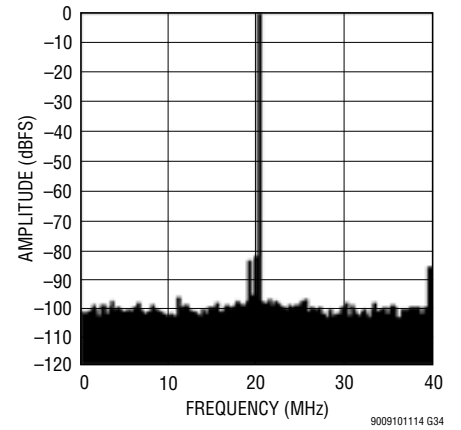

**LTM9009-14: 8k Point 2-Tone FFT,  $f_{IN} = 70\text{MHz}$ ,  $75\text{MHz}$ ,  $-7\text{dBFS}$  per Tone,  $80\text{Mpsps}$**

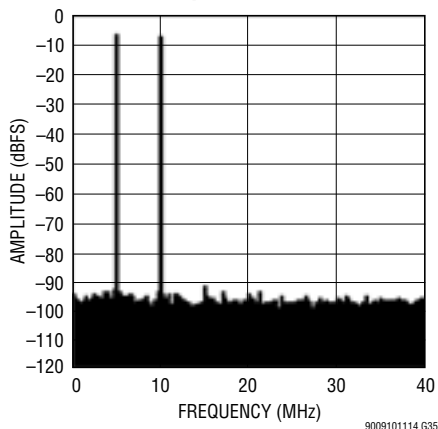

**LTM9009-14: Shorted Input Histogram**

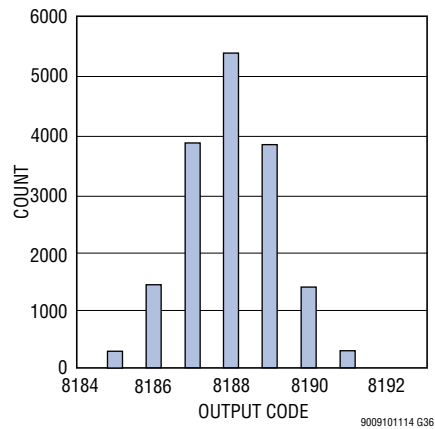



## TYPICAL PERFORMANCE CHARACTERISTICS

**LTM9009-14: SNR vs Input Frequency, -1dBFS, 2V Range, 80Msps**

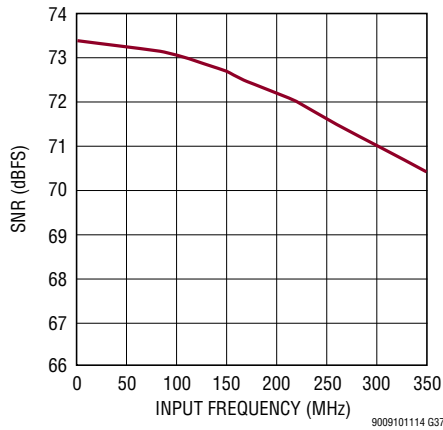

**LTM9009-14: SFDR vs Input Frequency, -1dBFS, 2V Range, 80Msps**

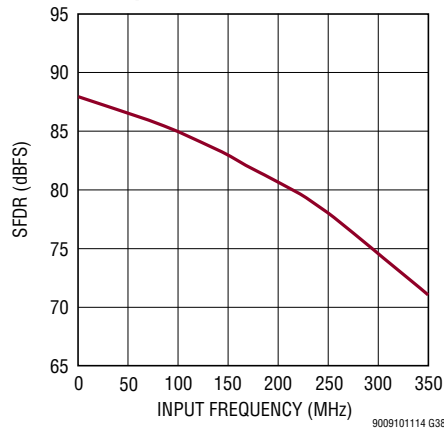

**LTM9009-14: SFDR vs Input Level,  $f_{IN} = 70\text{MHz}$ , 2V Range, 80Msps**

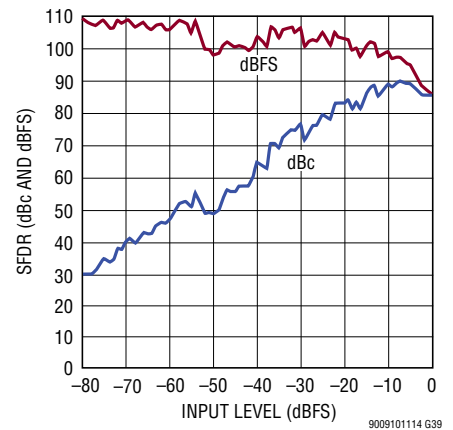

**LTM9009-14:  $I_{VDD}$  vs Sample Rate, 5MHz Sine Wave Input, -1dBFS**

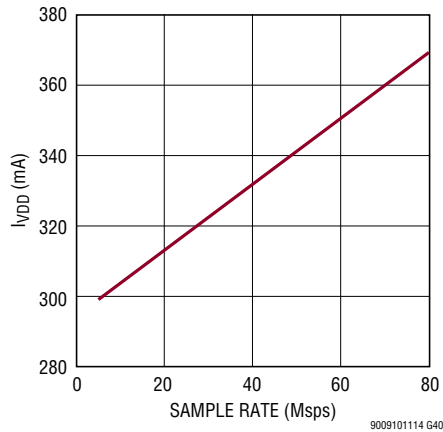

**LTM9009-14: SNR vs SENSE,  $f_{IN} = 5\text{MHz}$ , -1dBFS**

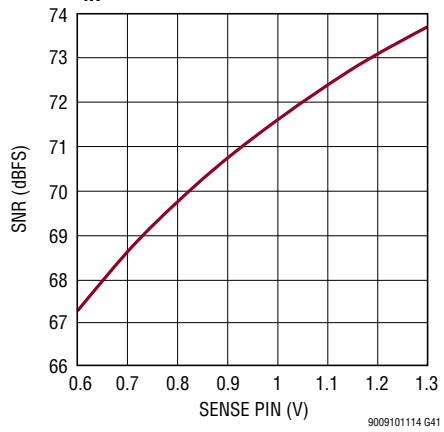

**DCO Cycle-Cycle Jitter vs Serial Data Rate**

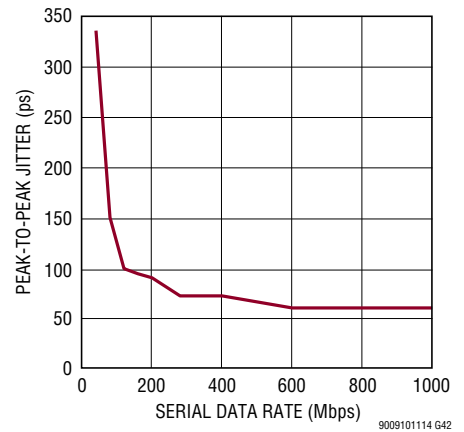

## PIN FUNCTIONS

**A<sub>IN1</sub><sup>+</sup> (B2):** Channel 1 Positive Differential Analog Input.

**A<sub>IN1</sub><sup>-</sup> (B1):** Channel 1 Negative Differential Analog Input.

**V<sub>CM14</sub> (B3):** Common Mode Bias Output, Nominally Equal to  $V_{DD}/2$ .  $V_{CM}$  should be used to bias the common mode of the analog inputs of channels 1 and 4.  $V_{CM}$  is internally bypassed to ground with a 0.1 $\mu$ F ceramic capacitor. No external capacitance is required.

**A<sub>IN2</sub><sup>+</sup> (C2):** Channel 2 Positive Differential Analog Input.

**A<sub>IN2</sub><sup>-</sup> (C1):** Channel 2 Negative Differential Analog Input.

**A<sub>IN3</sub><sup>+</sup> (E2):** Channel 3 Positive Differential Analog Input.

**A<sub>IN3</sub><sup>-</sup> (E1):** Channel 3 Negative Differential Analog Input.

**V<sub>CM23</sub> (F3):** Common Mode Bias Output, Nominally Equal to  $V_{DD}/2$ .  $V_{CM}$  should be used to bias the common mode of the analog inputs of channels 2 and 3.  $V_{CM}$  is internally bypassed to ground with a 0.1 $\mu$ F ceramic capacitor. No external capacitance is required.

**A<sub>IN4</sub><sup>+</sup> (G2):** Channel 4 Positive Differential Analog Input.

**A<sub>IN4</sub><sup>-</sup> (G1):** Channel 4 Negative Differential Analog Input.

**A<sub>IN5</sub><sup>+</sup> (H1):** Channel 5 Positive Differential Analog Input.

**A<sub>IN5</sub><sup>-</sup> (H2):** Channel 5 Negative Differential Analog Input.

**V<sub>CM67</sub> (J3):** Common Mode Bias Output, Nominally Equal to  $V_{DD}/2$ .  $V_{CM}$  should be used to bias the common mode of the analog inputs of channels 6 and 7.  $V_{CM}$  is internally bypassed to ground with a 0.1 $\mu$ F ceramic capacitor. No external capacitance is required.

**A<sub>IN6</sub><sup>+</sup> (K1):** Channel 6 Positive Differential Analog Input.

**A<sub>IN6</sub><sup>-</sup> (K2):** Channel 6 Negative Differential Analog Input.

**A<sub>IN7</sub><sup>+</sup> (M1):** Channel 7 Positive Differential Analog Input.

**A<sub>IN7</sub><sup>-</sup> (M2):** Channel 7 Negative Differential Analog Input.

**V<sub>CM58</sub> (N3):** Common Mode Bias Output, Nominally Equal to  $V_{DD}/2$ .  $V_{CM}$  should be used to bias the common mode of the analog inputs of channels 5 and 8.  $V_{CM}$  is internally bypassed to ground with a 0.1 $\mu$ F ceramic capacitor. No external capacitance is required.

**A<sub>IN8</sub><sup>+</sup> (N1):** Channel 8 Positive Differential Analog Input.

**A<sub>IN8</sub><sup>-</sup> (N2):** Channel 8 Negative Differential Analog Input

**V<sub>DD</sub> (D3, D4, E3, E4, K3, K4, L3, L4):** 1.8V Analog Power Supply.  $V_{DD}$  is internally bypassed to ground with 0.1 $\mu$ F ceramic capacitors.

**ENC<sup>+</sup> (P5):** Encode Input. Conversion starts on the rising edge.

**ENC<sup>-</sup> (P6):** Encode Complement Input. Conversion starts on the falling edge.

**$\overline{CSA}$  (L5):** In serial programming mode, ( $PAR/\overline{SER} = 0V$ ),  $\overline{CSA}$  is the serial interface chip select input for registers controlling channels 1, 4, 5 and 8. When  $\overline{CS}$  is low, SCK is enabled for shifting data on SDI into the mode control registers. In parallel programming mode ( $PAR/\overline{SER} = V_{DD}$ ),  $\overline{CS}$  selects 2-lane or 1-lane output mode.  $\overline{CS}$  can be driven with 1.8V to 3.3V logic.

**$\overline{CSB}$  (M5):** In serial programming mode, ( $PAR/\overline{SER} = 0V$ ),  $\overline{CSB}$  is the serial interface chip select input for registers controlling channels 2, 3, 6 and 7. When  $\overline{CS}$  is low, SCK is enabled for shifting data on SDI into the mode control registers. In parallel programming mode ( $PAR/\overline{SER} = V_{DD}$ ),  $\overline{CS}$  selects 2-lane or 1-lane output mode.  $\overline{CS}$  can be driven with 1.8V to 3.3V logic.

**SCK (L6):** In serial programming mode, ( $PAR/\overline{SER} = 0V$ ), SCK is the serial interface clock input. In parallel programming mode ( $PAR/\overline{SER} = V_{DD}$ ), SCK selects 3.5mA or 1.75mA LVDS output currents. SCK can be driven with 1.8V to 3.3V logic.

**SDI (M6):** In serial programming mode, ( $PAR/\overline{SER} = 0V$ ), SDI is the serial interface data Input. Data on SDI is clocked into the mode control registers on the rising edge of SCK. In parallel programming mode ( $PAR/\overline{SER} = V_{DD}$ ), SDI can be used to power down the part. SDI can be driven with 1.8V to 3.3V logic.

**GND (See Pin Configuration Table):** ADC Power Ground. Use multiple vias close to pins.

## PIN FUNCTIONS

**OV<sub>DD</sub> (G9, G10):** Output Driver Supply. OV<sub>DD</sub> is internally bypassed to ground with a 0.1µF ceramic capacitor.

**SDOA (E6):** In serial programming mode, (PAR/ $\overline{\text{SER}} = 0\text{V}$ ), SDOA is the optional serial interface data output for registers controlling channels 1, 4, 5 and 8. Data on SDO is read back from the mode control registers and can be latched on the falling edge of SCK. SDO is an open-drain N-channel MOSFET output that requires an external 2k pull-up resistor from 1.8V to 3.3V. If read back from the mode control registers is not needed, the pull-up resistor is not necessary and SDO can be left unconnected. In parallel programming mode (PAR/ $\overline{\text{SER}} = V_{\text{DD}}$ ), SDOA is an input that enables internal 100Ω termination resistors on the digital outputs of channels 1, 4, 5 and 8. When used as an input, SDO can be driven with 1.8V to 3.3V logic through a 1k series resistor.

**SDOB (D6):** Serial Data Output Pin for Channels 2, 3, 6 and 7. See description for SDOA.

**PAR/ $\overline{\text{SER}}$  (A7):** Programming Mode Selection Pin. Connect to ground to enable the serial programming mode.  $\overline{\text{CSA}}$ ,  $\overline{\text{CSB}}$ , SCK, SDI, SDOA and SDOB become a serial interface that control the A/D operating modes. Connect to V<sub>DD</sub> to enable parallel programming mode where  $\overline{\text{CSA}}$ ,  $\overline{\text{CSB}}$ , SCK, SDI, SDOA and SDOB become parallel logic inputs that control a reduced set of the A/D operating modes. PAR/ $\overline{\text{SER}}$  should be connected directly to ground or the V<sub>DD</sub> of the part and not be driven by a logic signal.

**V<sub>REF</sub> (B6):** Reference Voltage Output. V<sub>REF</sub> is internally bypassed to ground with a 1µF ceramic capacitor, nominally 1.25V.

**SENSE (C5):** Reference Programming Pin. Connecting SENSE to V<sub>DD</sub> selects the internal reference and a ±1V input range. Connecting SENSE to ground selects the internal reference and a ±0.5V input range. An external reference between 0.625V and 1.3V applied to SENSE selects an input range of ±0.8 • V<sub>SENSE</sub>. SENSE is internally bypassed to ground with a 0.1µF ceramic capacitor.

## LVDS Outputs

**All pins in this section are differential LVDS outputs. The output current level is programmable. There is an optional internal 100Ω termination resistor between the pins of each LVDS output pair.**

**OUT1A<sup>-</sup>/OUT1A<sup>+</sup>, OUT1B<sup>-</sup>/OUT1B<sup>+</sup> (E7/E8, C8/D8):** Serial Data Outputs for Channel 1. In 1-lane output mode only OUT1A<sup>-</sup>/OUT1A<sup>+</sup> are used.

**OUT2A<sup>-</sup>/OUT2A<sup>+</sup>, OUT2B<sup>-</sup>/OUT2B<sup>+</sup> (B8/A8, D7/C7):** Serial Data Outputs for Channel 2. In 1-lane output mode only OUT2A<sup>-</sup>/OUT2A<sup>+</sup> are used.

**OUT3A<sup>-</sup>/OUT3A<sup>+</sup>, OUT3B<sup>-</sup>/OUT3B<sup>+</sup> (D10/D9, E10/E9):** Serial Data Outputs for Channel 3. In 1-lane output mode only OUT3A<sup>-</sup>/OUT3A<sup>+</sup> are used.

**OUT4A<sup>-</sup>/OUT4A<sup>+</sup>, OUT4B<sup>-</sup>/OUT4B<sup>+</sup> (C9/C10, F7/F8):** Serial Data Outputs for Channel 4. In 1-lane output mode only OUT4A<sup>-</sup>/OUT4A<sup>+</sup> are used.

**OUT5A<sup>-</sup>/OUT5A<sup>+</sup>, OUT5B<sup>-</sup>/OUT5B<sup>+</sup> (J8/J7, K8/K7):** Serial Data Outputs for Channel 5. In 1-lane output mode only OUT5A<sup>-</sup>/OUT5A<sup>+</sup> are used.

**OUT6A<sup>-</sup>/OUT6A<sup>+</sup>, OUT6B<sup>-</sup>/OUT6B<sup>+</sup> (K9/K10, L9/L10):** Serial Data Outputs for Channel 6. In 1-lane output mode only OUT6A<sup>-</sup>/OUT6A<sup>+</sup> are used.

**OUT7A<sup>-</sup>/OUT7A<sup>+</sup>, OUT7B<sup>-</sup>/OUT7B<sup>+</sup> (M7/L7, P8/N8):** Serial Data Outputs for Channel 7. In 1-lane output mode only OUT7A<sup>-</sup>/OUT7A<sup>+</sup> are used.

**OUT8A<sup>-</sup>/OUT8A<sup>+</sup>, OUT8B<sup>-</sup>/OUT8B<sup>+</sup> (L8/M8, M10/M9):** Serial Data Outputs for Channel 8. In 1-lane output mode only OUT8A<sup>-</sup>/OUT8A<sup>+</sup> are used.

**FRA<sup>-</sup>/FRA<sup>+</sup> (H7/H8):** Frame Start Outputs for Channels 1, 4, 5 and 8.

**FRB<sup>-</sup>/FRB<sup>+</sup> (J9/J10):** Frame Start Outputs for Channels 2, 3, 6 and 7.

**DCOA<sup>-</sup>/DCOA<sup>+</sup> (G8/G7):** Data Clock Outputs for Channels 1, 4, 5 and 8.

**DCOB<sup>-</sup>/DCOB<sup>+</sup> (F10, F9):** Data Clock Outputs for Channels 2, 3, 6 and 7.

## PIN CONFIGURATION TABLE

|          | 1                             | 2                             | 3                 | 4               | 5                       | 6                | 7                  | 8                  | 9                  | 10                 |
|----------|-------------------------------|-------------------------------|-------------------|-----------------|-------------------------|------------------|--------------------|--------------------|--------------------|--------------------|
| <b>A</b> | GND                           | GND                           | GND               | GND             | GND                     | GND              | PAR/SER            | OUT2A <sup>+</sup> | GND                | GND                |
| <b>B</b> | A <sub>IN1</sub> <sup>-</sup> | A <sub>IN1</sub> <sup>+</sup> | V <sub>CM14</sub> | GND             | GND                     | V <sub>REF</sub> | GND                | OUT2A <sup>-</sup> | GND                | GND                |
| <b>C</b> | A <sub>IN2</sub> <sup>-</sup> | A <sub>IN2</sub> <sup>+</sup> | GND               | GND             | SENSE                   | GND              | OUT2B <sup>+</sup> | OUT1B <sup>-</sup> | OUT4A <sup>-</sup> | OUT4A <sup>+</sup> |
| <b>D</b> | GND                           | GND                           | V <sub>DD</sub>   | V <sub>DD</sub> | GND                     | SDOB             | OUT2B <sup>-</sup> | OUT1B <sup>+</sup> | OUT3A <sup>+</sup> | OUT3A <sup>-</sup> |
| <b>E</b> | A <sub>IN3</sub> <sup>-</sup> | A <sub>IN3</sub> <sup>+</sup> | V <sub>DD</sub>   | V <sub>DD</sub> | GND                     | SDOA             | OUT1A <sup>-</sup> | OUT1A <sup>+</sup> | OUT3B <sup>+</sup> | OUT3B <sup>-</sup> |
| <b>F</b> | GND                           | GND                           | V <sub>CM23</sub> | GND             | GND                     | GND              | OUT4B <sup>-</sup> | OUT4B <sup>+</sup> | DCOB <sup>+</sup>  | DCOB <sup>-</sup>  |
| <b>G</b> | A <sub>IN4</sub> <sup>-</sup> | A <sub>IN4</sub> <sup>+</sup> | GND               | GND             | GND                     | GND              | DCOA <sup>+</sup>  | DCOA <sup>-</sup>  | OV <sub>DD</sub>   | OV <sub>DD</sub>   |
| <b>H</b> | A <sub>IN5</sub> <sup>+</sup> | A <sub>IN5</sub> <sup>-</sup> | GND               | GND             | GND                     | GND              | FRA <sup>-</sup>   | FRA <sup>+</sup>   | GND                | GND                |
| <b>J</b> | GND                           | GND                           | V <sub>CM67</sub> | GND             | GND                     | GND              | OUT5A <sup>+</sup> | OUT5A <sup>-</sup> | FRB <sup>-</sup>   | FRB <sup>+</sup>   |
| <b>K</b> | A <sub>IN6</sub> <sup>+</sup> | A <sub>IN6</sub> <sup>-</sup> | V <sub>DD</sub>   | V <sub>DD</sub> | GND                     | GND              | OUT5B <sup>+</sup> | OUT5B <sup>-</sup> | OUT6A <sup>-</sup> | OUT6A <sup>+</sup> |
| <b>L</b> | GND                           | GND                           | V <sub>DD</sub>   | V <sub>DD</sub> | $\overline{\text{CSA}}$ | SCK              | OUT7A <sup>+</sup> | OUT8A <sup>-</sup> | OUT6B <sup>-</sup> | OUT6B <sup>+</sup> |
| <b>M</b> | A <sub>IN7</sub> <sup>+</sup> | A <sub>IN7</sub> <sup>-</sup> | GND               | GND             | $\overline{\text{CSB}}$ | SDI              | OUT7A <sup>-</sup> | OUT8A <sup>+</sup> | OUT8B <sup>+</sup> | OUT8B <sup>-</sup> |
| <b>N</b> | A <sub>IN8</sub> <sup>+</sup> | A <sub>IN8</sub> <sup>-</sup> | V <sub>CM58</sub> | GND             | GND                     | GND              | GND                | OUT7B <sup>+</sup> | GND                | GND                |
| <b>P</b> | GND                           | GND                           | GND               | GND             | ENC <sup>+</sup>        | ENC <sup>-</sup> | GND                | OUT7B <sup>-</sup> | GND                | GND                |

Top View of BGA Package (Looking Through Component).

# FUNCTIONAL BLOCK DIAGRAM

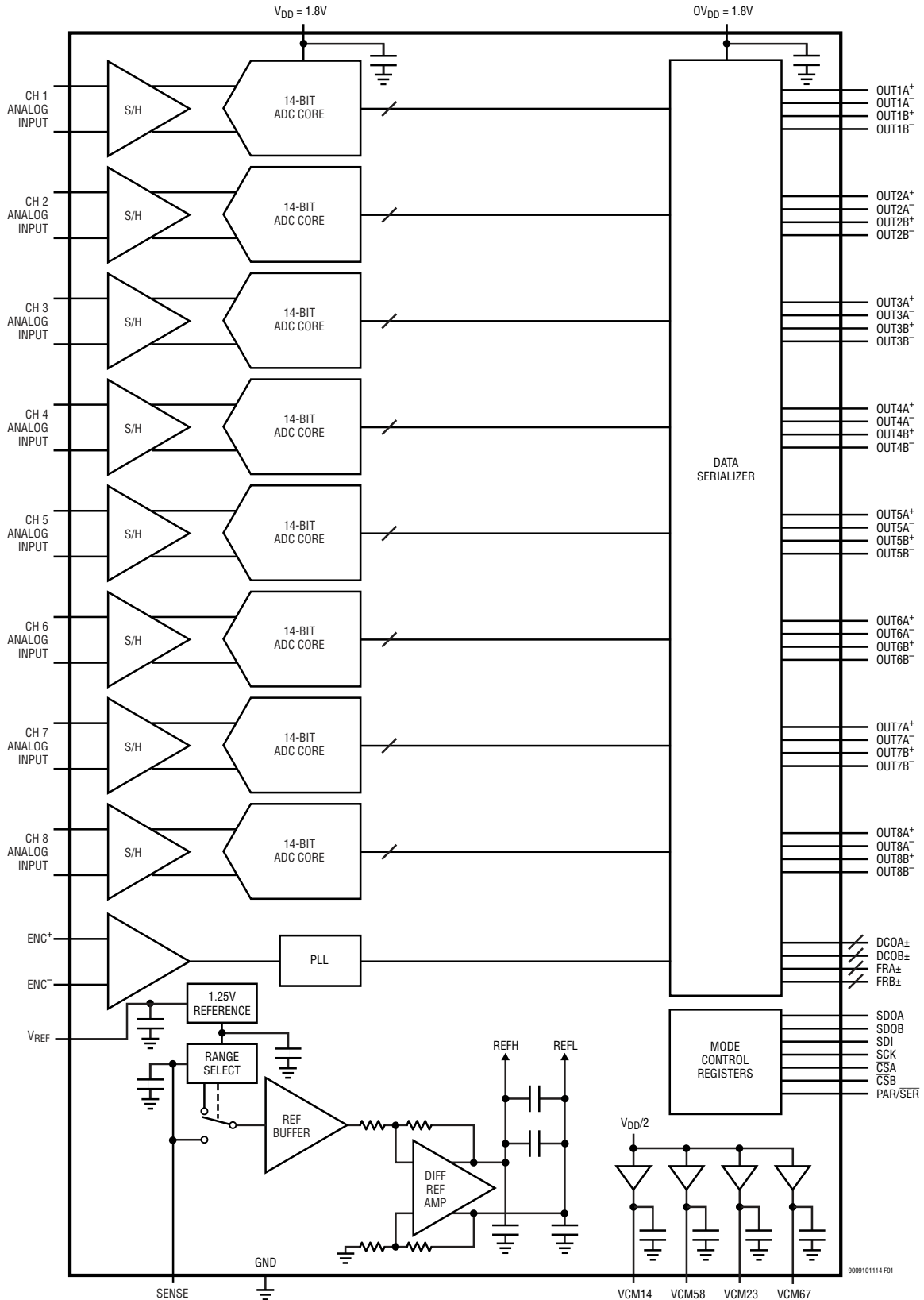

Figure 1. Figure 1. Functional Block Diagram

## APPLICATIONS INFORMATION

### CONVERTER OPERATION

The LTM9011-14/LTM9010-14/LTM9009-14 are low power, 8-channel, 14-bit, 125Msps/105Msps/80Msps A/D converters that are powered by a single 1.8V supply. The analog inputs should be driven differentially. The encode input can be driven differentially for optimal jitter performance, or single-ended for lower power consumption. The digital outputs are serial LVDS to minimize the number of data lines. Each channel outputs two bits at a time (2-lane mode). At lower sampling rates there is a one bit per channel option (1-lane mode). Many additional features can be chosen by programming the mode control registers through a serial SPI port.

### ANALOG INPUT

The analog inputs are differential CMOS sample-and-hold circuits (Figure 2). The inputs should be driven differentially around a common mode voltage set by the appropriate  $V_{CM}$  output pins, which are nominally  $V_{DD}/2$ . For the 2V input range, the inputs should swing from  $V_{CM} - 0.5V$  to  $V_{CM} + 0.5V$ . There should be  $180^\circ$  phase difference between the inputs.

The eight channels are simultaneously sampled by a shared encode circuit (Figure 2).

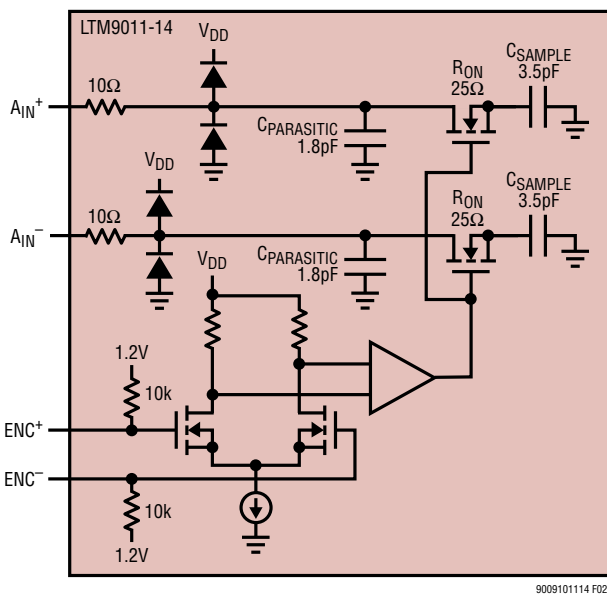

Figure 2. Equivalent Input Circuit. Only One of the Eight Analog Channels Is Shown

### INPUT DRIVE CIRCUITS

#### Input Filtering

If possible, there should be an RC low pass filter right at the analog inputs. This lowpass filter isolates the drive circuitry from the A/D sample-and-hold switching, and also limits wideband noise from the drive circuitry. Figure 3 shows an example of an input RC filter. The RC component values should be chosen based on the application's input frequency.

#### Transformer Coupled Circuits

Figure 3 shows the analog input being driven by an RF transformer with a center-tapped secondary. The center tap is biased with  $V_{CM}$ , setting the A/D input at its optimal DC level. At higher input frequencies a transmission line balun transformer (Figures 4 to 6) has better balance, resulting in lower A/D distortion.

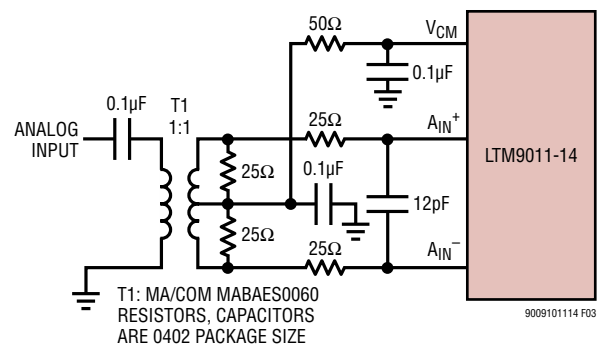

Figure 3. Analog Input Circuit Using a Transformer. Recommended for Input Frequencies from 5MHz to 70MHz

## APPLICATIONS INFORMATION

### Amplifier Circuits

Figure 7 shows the analog input being driven by a high speed differential amplifier. The output of the amplifier is AC-coupled to the A/D so the amplifier's output common mode voltage can be optimally set to minimize distortion. See back page for a DC-coupled example.

At very high frequencies an RF gain block will often have lower distortion than a differential amplifier. If the gain block is single-ended, then a transformer circuit (Figures 4 to 6) should convert the signal to differential before driving the A/D.

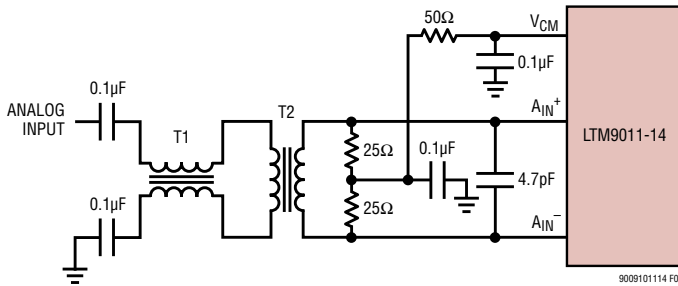

T1: MA/COM MABA-007159-000000  
T2: MA/COM MABAE0060  
RESISTORS, CAPACITORS ARE 0402 PACKAGE SIZE

**Figure 4. Recommended Front End Circuit for Input Frequencies from 70MHz to 170MHz**

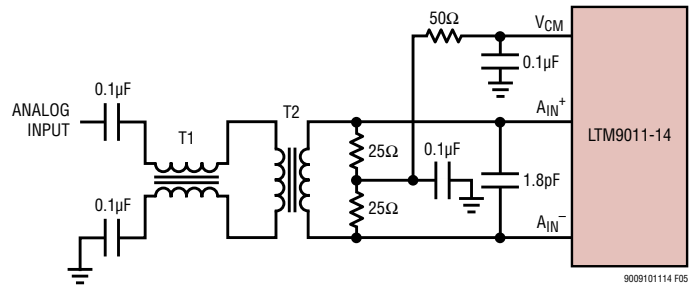

T1: MA/COM MABA-007159-000000  
T2: COILCRAFT WBC1-1LB  
RESISTORS, CAPACITORS ARE 0402 PACKAGE SIZE

**Figure 5. Recommended Front End Circuit for Input Frequencies from 170MHz to 300MHz**

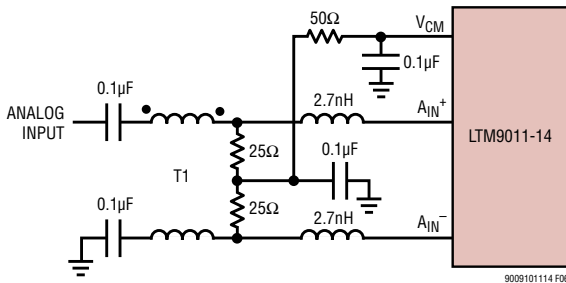

T1: MA/COM ETC1-1-13  
RESISTORS, CAPACITORS ARE 0402 PACKAGE SIZE

**Figure 6. Recommended Front End Circuit for Input Frequencies Above 300MHz**

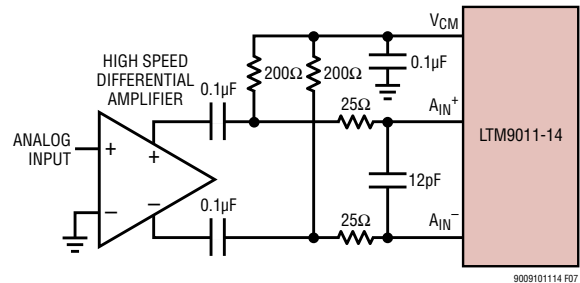

**Figure 7. Front End Circuit Using a High Speed Differential Amplifier**

## APPLICATIONS INFORMATION

### Reference

The LTM9011-14/LTM9010-14/LTM9009-14 has an internal 1.25V voltage reference. For a 2V input range using the internal reference, connect SENSE to  $V_{DD}$ . For a 1V input range using the internal reference, connect SENSE to ground. For a 2V input range with an external reference, apply a 1.25V reference voltage to SENSE (Figure 9).

The input range can be adjusted by applying a voltage to SENSE that is between 0.625V and 1.30V. The input range will then be  $1.6 \cdot V_{SENSE}$ . The reference is shared by all eight ADC channels, so it is not possible to independently adjust the input range of individual channels.

The  $V_{REF}$ , SENSE, REFH and REFL pins are internally bypassed, as shown in Figure 8.

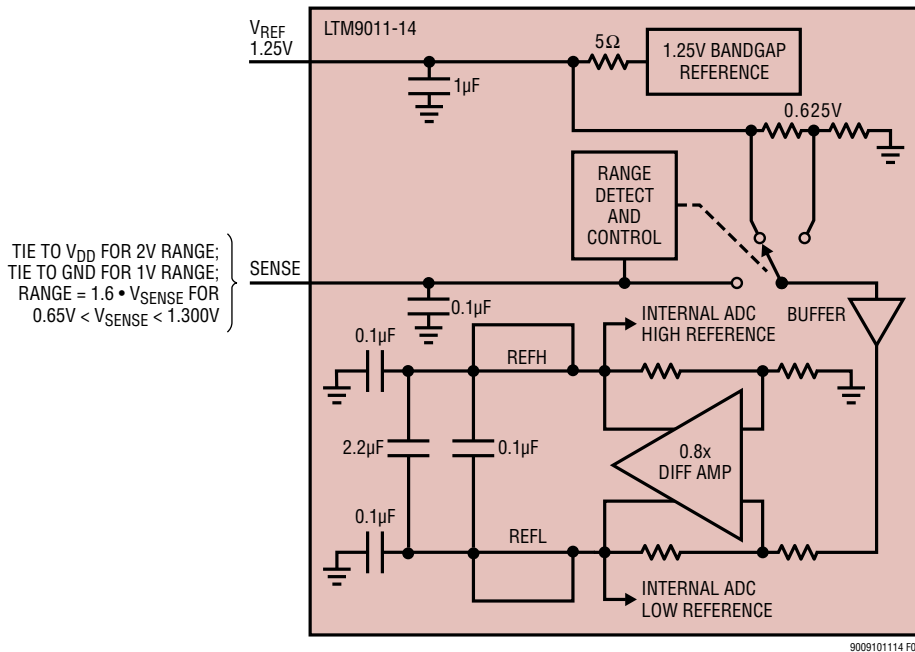

Figure 8. Reference Circuit

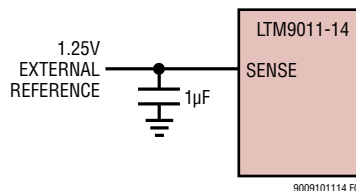

Figure 9. Using an External 1.25V Reference



## APPLICATIONS INFORMATION

### Encode Input

The signal quality of the encode inputs strongly affects the A/D noise performance. The encode inputs should be treated as analog signals—do not route them next to digital traces on the circuit board. There are two modes of operation for the encode inputs: the differential encode mode (Figure 10), and the single-ended encode mode (Figure 11).

The differential encode mode is recommended for sinusoidal, PECL, or LVDS encode inputs (Figures 12 and 13).

The encode inputs are internally biased to 1.2V through 10k equivalent resistance. The encode inputs can be taken above  $V_{DD}$  (up to 3.6V), and the common mode range is from 1.1V to 1.6V. In the differential encode mode,  $ENC^-$  should stay at least 200mV above ground to avoid falsely triggering the single-ended encode mode. For good jitter performance  $ENC^+$  should have fast rise and fall times.

The single-ended encode mode should be used with CMOS encode inputs. To select this mode,  $ENC^-$  is connected to ground and  $ENC^+$  is driven with a square wave

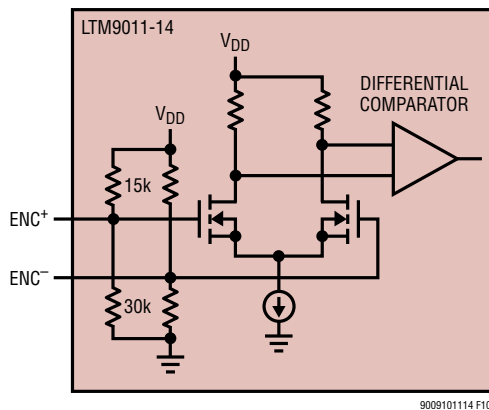

Figure 10. Equivalent Encode Input Circuit for Differential Encode Mode

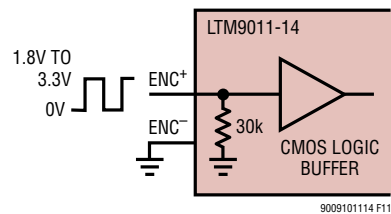
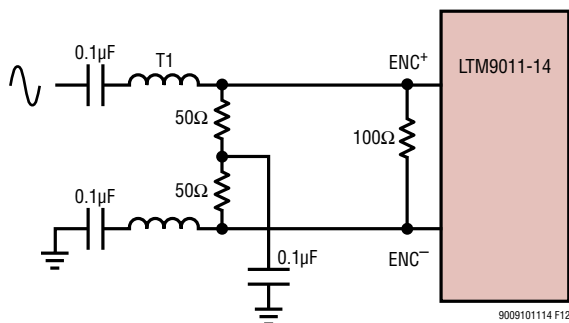

Figure 11. Equivalent Encode Input Circuit for Single-Ended Encode Mode



T1 = MA/COM ETC1-1-13  
RESISTORS AND CAPACITORS  
ARE 0402 PACKAGE SIZE

Figure 12. Sinusoidal Encode Drive

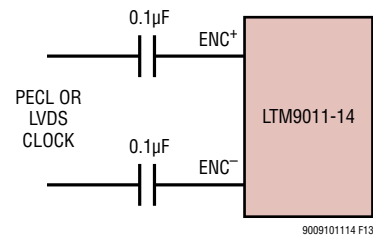

Figure 13. PECL or LVDS Encode Drive

## APPLICATIONS INFORMATION

encode input. ENC<sup>+</sup> can be taken above V<sub>DD</sub> (up to 3.6V) so 1.8V to 3.3V CMOS logic levels can be used. The ENC<sup>+</sup> threshold is 0.9V. For good jitter performance ENC<sup>+</sup> should have fast rise and fall times.

### Clock PLL and Duty Cycle Stabilizer

The encode clock is multiplied by an internal phase-locked loop (PLL) to generate the serial digital output data. If the encode signal changes frequency or is turned off, the PLL requires 25μs to lock onto the input clock.

A clock duty cycle stabilizer circuit allows the duty cycle of the applied encode signal to vary from 30% to 70%. In the serial programming mode it is possible to disable the duty cycle stabilizer, but this is not recommended. In the parallel programming mode the duty cycle stabilizer is always enabled.

### DIGITAL OUTPUTS

The digital outputs of the LTM9011-14/LTM9010-14/LTM9009-14 are serialized LVDS signals. Each channel outputs two bits at a time (2-lane mode). At lower sampling rates there is a one bit per channel option (1-lane mode). The data can be serialized with 16, 14, or 12-bit

serialization (see the Timing Diagrams section for details). Note that with 12-bit serialization the two LSBs are not available—this mode is included for compatibility with 12-bit versions of these parts.

The output data should be latched on the rising and falling edges of the data clock out (DCO). A data frame output (FR) can be used to determine when the data from a new conversion result begins. In the 2-lane, 14-bit serialization mode, the frequency of the FR output is halved.

The maximum serial data rate for the data outputs is 1Gbps, so the maximum sample rate of the ADC will depend on the serialization mode as well as the speed grade of the ADC (see Table 1). The minimum sample rate for all serialization modes is 5MSPS.

By default the outputs are standard LVDS levels: 3.5mA output current and a 1.25V output common mode voltage. An external 100Ω differential termination resistor is required for each LVDS output pair. The termination resistors should be located as close as possible to the LVDS receiver.

The outputs are powered by OV<sub>DD</sub> which is independent from the A/D core power.

**Table 1. Maximum Sampling Frequency for All Serialization Modes. Note That These Limits Are for the LTM9011-14. The Sampling Frequency for the Slower Speed Grades Cannot Exceed 105MHz (LTM9010-14) or 80MHz (LTM9009-14).**

| SERIALIZATION MODE |                      | MAXIMUM SAMPLING FREQUENCY, f <sub>S</sub> (MHz) | DCO FREQUENCY        | FR FREQUENCY         | SERIAL DATA RATE    |
|--------------------|----------------------|--|----------------------|----------------------|---------------------|
| 2-Lane             | 16-Bit Serialization | 125  | 4 • f <sub>S</sub>   | f <sub>S</sub>       | 8 • f <sub>S</sub>  |
| 2-Lane             | 14-Bit Serialization | 125  | 3.5 • f <sub>S</sub> | 0.5 • f <sub>S</sub> | 7 • f <sub>S</sub>  |
| 2-Lane             | 12-Bit Serialization | 125  | 3 • f <sub>S</sub>   | f <sub>S</sub>       | 6 • f <sub>S</sub>  |
| 1-Lane             | 16-Bit Serialization | 62.5   | 8 • f <sub>S</sub>   | f <sub>S</sub>       | 16 • f <sub>S</sub> |
| 1-Lane             | 14-Bit Serialization | 71.4   | 7 • f <sub>S</sub>   | f <sub>S</sub>       | 14 • f <sub>S</sub> |
| 1-Lane             | 12-Bit Serialization | 83.3   | 6 • f <sub>S</sub>   | f <sub>S</sub>       | 12 • f <sub>S</sub> |

## APPLICATIONS INFORMATION

### Programmable LVDS Output Current

The default output driver current is 3.5mA. This current can be adjusted by control register A2 in the serial programming mode. Available current levels are 1.75mA, 2.1mA, 2.5mA, 3mA, 3.5mA, 4mA and 4.5mA. In the parallel programming mode, the SCK pin can select either 3.5mA or 1.75mA.

### Optional LVDS Driver Internal Termination

In most cases, using just an external 100Ω termination resistor will give excellent LVDS signal integrity. In addition, an optional internal 100Ω termination resistor can be enabled by serially programming mode control register A2. The internal termination helps absorb any reflections caused by imperfect termination at the receiver. When the internal termination is enabled, the output driver current is doubled to maintain the same output voltage swing. In the parallel programming mode the SDO pin enables internal termination. Internal termination should only be used with 1.75mA, 2.1mA or 2.5mA LVDS output current modes.

### DATA FORMAT

Table 2 shows the relationship between the analog input voltage and the digital data output bits. By default the output data format is offset binary. The 2's complement format can be selected by serially programming mode control register A1.

Table 2. Output Codes vs Input Voltage

| $A_{IN}^+ - A_{IN}^-$<br>(2V RANGE) | D13-D0<br>(OFFSET BINARY) | D13-D0<br>(2's COMPLEMENT) |
|-------------------------------------|---------------------------|----------------------------|
| >1.000000V                          | 11 1111 1111 1111         | 01 1111 1111 1111          |
| +0.999878V                          | 11 1111 1111 1111         | 01 1111 1111 1111          |
| +0.999756V                          | 11 1111 1111 1110         | 01 1111 1111 1110          |
| +0.000122V                          | 10 0000 0000 0001         | 00 0000 0000 0001          |
| +0.000000V                          | 10 0000 0000 0000         | 00 0000 0000 0000          |
| -0.000122V                          | 01 1111 1111 1111         | 11 1111 1111 1111          |
| -0.000244V                          | 01 1111 1111 1110         | 11 1111 1111 1110          |
| -0.999878V                          | 00 0000 0000 0001         | 10 0000 0000 0001          |
| -1.000000V                          | 00 0000 0000 0000         | 10 0000 0000 0000          |
| <-1.000000V                         | 00 0000 0000 0000         | 10 0000 0000 0000          |

### Digital Output Randomizer

Interference from the A/D digital outputs is sometimes unavoidable. Digital interference may be from capacitive or inductive coupling or coupling through the ground plane. Even a tiny coupling factor can cause unwanted tones in the ADC output spectrum. By randomizing the digital output before it is transmitted off chip, these unwanted tones can be randomized which reduces the unwanted tone amplitude.

The digital output is randomized by applying an exclusive-OR logic operation between the LSB and all other data output bits. To decode, the reverse operation is applied—an exclusive-OR operation is applied between the LSB and all other bits. The FR and DCO outputs are not affected. The output randomizer is enabled by serially programming mode control register A1.

## APPLICATIONS INFORMATION

### Digital Output Test Pattern

To allow in-circuit testing of the digital interface to the A/D, there is a test mode that forces the A/D data outputs (D13-D0) of all channels to known values. The digital output test patterns are enabled by serially programming mode control registers A3 and A4. When enabled, the test patterns override all other formatting modes: 2's complement and randomizer.

### Output Disable

The digital outputs may be disabled by serially programming mode control register A2. The current drive for all digital outputs including DCO and FR are disabled to save power or enable in-circuit testing. When disabled the common mode of each output pair becomes high impedance, but the differential impedance may remain low.

### Sleep and Nap Modes

The A/D may be placed in sleep or nap modes to conserve power. In sleep mode the entire device is powered down, resulting in 2mW power consumption. Sleep mode is enabled by mode control register A1 (serial programming mode), or by SDI (parallel programming mode). The time required to recover from sleep mode is about 2ms.

In nap mode any combination of A/D channels can be powered down while the internal reference circuits and the PLL stay active, allowing faster wakeup than from sleep mode. Recovering from nap mode requires at least 100 clock cycles. If the application demands very accurate DC settling then an additional 50 $\mu$ s should be allowed so the on-chip references can settle from the slight temperature shift caused by the change in supply current as the A/D leaves nap mode. Nap mode is enabled by mode control register A1 in the serial programming mode.

## DEVICE PROGRAMMING MODES

The operating modes of the LTM9011-14/LTM9010-14/LTM9009-14 can be programmed by either a parallel interface or a simple serial interface. The serial interface has more flexibility and can program all available modes. The parallel interface is more limited and can only program some of the more commonly used modes.

### Parallel Programming Mode

To use the parallel programming mode,  $\overline{\text{PAR}}/\overline{\text{SER}}$  should be tied to  $V_{\text{DD}}$ . The  $\overline{\text{CS}}$ , SCK, SDI and SDO pins are binary logic inputs that set certain operating modes. These pins can be tied to  $V_{\text{DD}}$  or ground, or driven by 1.8V, 2.5V, or 3.3V CMOS logic. When used as an input, SDO should be driven through a 1k series resistor. Table 3 shows the modes set by  $\overline{\text{CS}}$ , SCK, SDI and SDO.

**Table 3. Parallel Programming Mode Control Bits ( $\overline{\text{PAR}}/\overline{\text{SER}} = V_{\text{DD}}$ )**

| Pin                    | DESCRIPTION  |
|------------------------|--|
| $\overline{\text{CS}}$ | <b>2-Lane / 1-Lane Selection Bit</b><br>0 = 2-Lane, 16-Bit Serialization Output Mode<br>1 = 1-Lane, 14-Bit Serialization Output Mode |
| SCK                    | <b>LVDS Current Selection Bit</b><br>0 = 3.5mA LVDS Current Mode<br>1 = 1.75mA LVDS Current Mode                                     |
| SDI                    | <b>Power Down Control Bit</b><br>0 = Normal Operation<br>1 = Sleep Mode  |
| SDO                    | <b>Internal Termination Selection Bit</b><br>0 = Internal Termination Disabled<br>1 = Internal Termination Enabled                   |

### Serial Programming Mode

To use the serial programming mode,  $\overline{\text{PAR}}/\overline{\text{SER}}$  should be tied to ground. The  $\overline{\text{CS}}$ , SCK, SDI and SDO pins become a serial interface that program the A/D mode control registers. Data is written to a register with a 16-bit serial word. Data can also be read back from a register to verify its contents.

Serial data transfer starts when  $\overline{\text{CS}}$  is taken low. The data on the SDI pin is latched at the first 16 rising

## APPLICATIONS INFORMATION

edges of SCK. Any SCK rising edges after the first 16 are ignored. The data transfer ends when  $\overline{CS}$  is taken high again.

The first bit of the 16-bit input word is the  $R/\overline{W}$  bit. The next seven bits are the address of the register (A6:A0). The final eight bits are the register data (D7:D0).

If the  $R/\overline{W}$  bit is low, the serial data (D7:D0) will be written to the register set by the address bits (A6:A0). If the  $R/\overline{W}$  bit is high, data in the register set by the address

bits (A6:A0) will be read back on the SDO pin (see the Timing Diagrams section). During a read back command the register is not updated and data on SDI is ignored.

The SDO pin is an open-drain output that pulls to ground with a 200 $\Omega$  impedance. If register data is read back through SDO, an external 2k pull-up resistor is required. If serial data is only written and read back is not needed, then SDO can be left floating and no pull-up resistor is needed. Table 4 shows a map of the mode control registers.

**Table 4. Serial Programming Mode Register Map ( $\overline{PAR}/\overline{SER} = \text{GND}$ )**

**REGISTER A0: RESET REGISTER (ADDRESS 00h)**

| D7    | D6 | D5 | D4 | D3 | D2 | D1 | D0 |
|-------|----|----|----|----|----|----|----|
| RESET | X  | X  | X  | X  | X  | X  | X  |

Note That  $\overline{CSA}$  Controls Channels 1, 4, 5 and 8,  $\overline{CSB}$  Controls Channels 2, 3, 6 and 7.

Bit 7           **RESET**            Software Reset Bit

0 = Not Used

1 = Software Reset. All Mode Control Registers Are Reset to 00h. The ADC Is Momentarily Placed in SLEEP Mode.

After the Reset SPI Write Command Is Complete, Bit D7 Is Automatically Set Back to Zero. The Reset Register Is Write Only.

Bits 6-0        Unused, Don't Care Bits.

**REGISTER A1 ( $\overline{CSA}$ ): FORMAT AND POWER-DOWN REGISTER (ADDRESS 01h with  $\overline{CSA} = \text{GND}$ )**

| D7     | D6   | D5       | D4    | D3    | D2    | D1    | D0    |
|--------|------|----------|-------|-------|-------|-------|-------|
| DCSOFF | RAND | TWOSCOMP | SLEEP | NAP_8 | NAP_5 | NAP_4 | NAP_1 |

Note That  $\overline{CSA}$  Controls Channels 1, 4, 5 and 8,  $\overline{CSB}$  Controls Channels 2, 3, 6 and 7.

Bit 7           **DCSOFF**            Clock Duty Cycle Stabilizer Bit

0 = Clock Duty Cycle Stabilizer On

1 = Clock Duty Cycle Stabilizer Off. This Is Not Recommended.

Bit 6           **RAND**                Data Output Randomizer Mode Control Bit

0 = Data Output Randomizer Mode Off

1 = Data Output Randomizer Mode On

Bit 5           **TWOSCOMP**        Two's Complement Mode Control Bit

0 = Offset Binary Data Format

1 = Two's Complement Data Format

Bits 4-0       **SLEEP: NAP\_X**    Sleep/Nap Mode Control Bits

00000 = Normal Operation

0XXX1 = Channel 1 in Nap Mode

0XX1X = Channel 4 in Nap Mode

0X1XX = Channel 5 in Nap Mode

01XXX = Channel 8 in Nap Mode

1XXXX = Sleep Mode. Channels 1, 4, 5 and 8 Are Disabled

Note: Any Combination of Channels Can Be Placed in Nap Mode.

## APPLICATIONS INFORMATION

### REGISTER A1 ( $\overline{\text{CSB}}$ ): FORMAT AND POWER-DOWN REGISTER (ADDRESS 01h with $\overline{\text{CSB}} = \text{GND}$ )

| D7     | D6   | D5       | D4    | D3    | D2    | D1    | D0    |
|--------|------|----------|-------|-------|-------|-------|-------|
| DCSOFF | RAND | TWOSCOMP | SLEEP | NAP_7 | NAP_6 | NAP_3 | NAP_2 |

Note That  $\overline{\text{CSA}}$  Controls Channels 1, 4, 5 and 8,  $\overline{\text{CSB}}$  Controls Channels 2, 3, 6 and 7.

- Bit 7      **DCSOFF**      Clock Duty Cycle Stabilizer Bit  
0 = Clock Duty Cycle Stabilizer On  
1 = Clock Duty Cycle Stabilizer Off. This Is Not Recommended.
- Bit 6      **RAND**      Data Output Randomizer Mode Control Bit  
0 = Data Output Randomizer Mode Off  
1 = Data Output Randomizer Mode On
- Bit 5      **TWOSCOMP**      Two's Complement Mode Control Bit  
0 = Offset Binary Data Format  
1 = Two's Complement Data Format
- Bits 4-0      **SLEEP: NAP\_4:NAP\_1**      Sleep/Nap Mode Control Bits  
0000 = Normal Operation  
0XXX1 = Channel 2 in Nap Mode  
0XX1X = Channel 3 in Nap Mode  
0X1XX = Channel 6 in Nap Mode  
01XXX = Channel 7 in Nap Mode  
1XXXX = Sleep Mode. Channels 2, 3, 6 and 7 Are Disabled  
Note: Any Combination of Channels Can Be Placed in Nap Mode.

### REGISTER A2: OUTPUT MODE REGISTER (ADDRESS 02h)

| D7     | D6     | D5     | D4     | D3     | D2       | D1       | D0       |
|--------|--------|--------|--------|--------|----------|----------|----------|
| ILVDS2 | ILVDS1 | ILVDS0 | TERMON | OUTOFF | OUTMODE2 | OUTMODE1 | OUTMODE0 |

Note That  $\overline{\text{CSA}}$  Controls Channels 1, 4, 5 and 8,  $\overline{\text{CSB}}$  Controls Channels 2, 3, 6 and 7.

- Bits 7-5      **ILVDS2:ILVDS0**      LVDS Output Current Bits  
000 = 3.5mA LVDS Output Driver Current  
001 = 4.0mA LVDS Output Driver Current  
010 = 4.5mA LVDS Output Driver Current  
011 = Not Used  
100 = 3.0mA LVDS Output Driver Current  
101 = 2.5mA LVDS Output Driver Current  
110 = 2.1mA LVDS Output Driver Current  
111 = 1.75mA LVDS Output Driver Current
- Bit 4      **TERMON**      LVDS Internal Termination Bit  
0 = Internal Termination Off  
1 = Internal Termination On. LVDS Output Driver Current Is 2x the Current Set by ILVDS2:ILVDS0. Internal Termination Should Only Be Used with 1.75mA, 2.1mA or 2.5mA LVDS Output Current Modes.
- Bit 3      **OUTOFF**      Output Disable Bit  
0 = Digital Outputs Are Enabled.  
1 = Digital Outputs Are Disabled.
- Bits 2-0      **OUTMODE2:OUTMODE0**      Digital Output Mode Control Bits  
000 = 2-Lanes, 16-Bit Serialization  
001 = 2-Lanes, 14-Bit Serialization  
010 = 2-Lanes, 12-Bit Serialization  
011 = Not Used  
100 = Not Used  
101 = 1-Lane, 14-Bit Serialization  
110 = 1-Lane, 12-Bit Serialization  
111 = 1-Lane, 16-Bit Serialization

## APPLICATIONS INFORMATION

### REGISTER A3: TEST PATTERN MSB REGISTER (ADDRESS 03h)

| D7      | D6 | D5   | D4   | D3   | D2   | D1  | D0  |
|---------|----|------|------|------|------|-----|-----|
| OUTTEST | X  | TP13 | TP12 | TP11 | TP10 | TP9 | TP8 |

Note That  $\overline{\text{CSA}}$  Controls Channels 1, 4, 5 and 8,  $\overline{\text{CSB}}$  Controls Channels 2, 3, 6 and 7.

Bit 7      **OUTTEST**      Digital Output Test Pattern Control Bit  
0 = Digital Output Test Pattern Off  
1 = Digital Output Test Pattern On

Bit 6      Unused, Don't Care Bit.

Bit 5-0    **TP13:TP8**      Test Pattern Data Bits (MSB)  
TP13:TP8 Set the Test Pattern for Data Bit 13 (MSB) Through Data Bit 8.

### REGISTER A4: TEST PATTERN LSB REGISTER (ADDRESS 04h)

| D7  | D6  | D5  | D4  | D3  | D2  | D1  | D0  |
|-----|-----|-----|-----|-----|-----|-----|-----|
| TP7 | TP6 | TP5 | TP4 | TP3 | TP2 | TP1 | TP0 |

Note That  $\overline{\text{CSA}}$  Controls Channels 1, 4, 5 and 8,  $\overline{\text{CSB}}$  Controls Channels 2, 3, 6 and 7.

Bit 7-0    **TP7:TP0**      Test Pattern Data Bits (LSB)  
TP7:TP0 Set the Test Pattern for Data Bit 7 Through Data Bit 0 (LSB).

### Software Reset

If serial programming is used, the mode control registers should be programmed as soon as possible after the power supplies turn on and are stable. The first serial command must be a software reset which will reset all register data bits to logic 0. To perform a software reset, bit D7 in the reset register is written with a logic 1. After the reset SPI write command is complete, bit D7 is automatically set back to zero.

### GROUNDING AND BYPASSING

The LTM9011-14/LTM9010-14/LTM9009-14 requires a printed circuit board with a clean unbroken ground plane. A multilayer board with an internal ground plane in the first layer beneath the ADC is recommended. Layout for the printed circuit board should ensure that digital and analog signal lines are separated as much as possible. In particular, care should be taken not to run any digital track alongside an analog signal track or underneath the ADC.

Bypass capacitors are integrated inside the package; additional capacitance is optional.

The analog inputs, encode signals, and digital outputs should not be routed next to each other. Ground fill and grounded vias should be used as barriers to isolate these signals from each other.

The pin assignments of the LTM9011-14/LTM9010-14/LTM9009-14 allow a flow-through layout that makes it possible to use multiple parts in a small area when a large number of ADC channels are required. The LTM9011 module has similar layout rules to other BGA packages. The layout can be implemented with 6mil blind vias and 5mil traces. The pinout has been designed to minimize the space required to route the analog and digital traces. The analog and digital traces can essentially be routed within the width of the package. This allows multiple packages to be located close together for high channel count applications. Trace lengths for the analog inputs and digital outputs should be matched as well as possible.

## APPLICATIONS INFORMATION

Table 5 lists the trace lengths for the analog inputs and digital outputs inside the package from the die pad to the package pad. These should be added to the PCB trace lengths for best matching.

The material used for the substrate is BT (bismaleimide-triazine), supplied by Mitsubishi Gas and Chemical. In the DC to 125MHz range, the speed for the analog input signals is 198ps/in or 7.795ps/mm. The speed for the digital outputs is 188.5ps/in or 7.417ps/mm.

## HEAT TRANSFER

Most of the heat generated by the LTM9011-14/LTM9010-14/LTM9009-14 is transferred from the die through the bottom of the package onto the printed circuit board. The ground pins should be connected to the internal ground planes by multiple vias.

Table 5. Internal Trace Lengths

| PIN | NAME               | LENGTH (mm) | PIN | NAME                          | LENGTH (mm) | PIN | NAME                          | LENGTH (mm) | PIN | NAME              | LENGTH (mm) |
|-----|--------------------|-------------|-----|-------------------------------|-------------|-----|-------------------------------|-------------|-----|-------------------|-------------|
| E7  | OUT1A <sup>-</sup> | 1.775       | K8  | OUT5B <sup>-</sup>            | 0.379       | E1  | A <sub>IN3</sub> <sup>-</sup> | 2.491       | F10 | DCOB <sup>-</sup> | 1.811       |
| E8  | OUT1A <sup>+</sup> | 1.947       | K7  | OUT5B <sup>+</sup>            | 0.528       | E2  | A <sub>IN3</sub> <sup>+</sup> | 2.505       | F9  | DCOB <sup>+</sup> | 1.812       |
| C8  | OUT1B <sup>-</sup> | 1.847       | K9  | OUT6A <sup>-</sup>            | 1.866       | G1  | A <sub>IN4</sub> <sup>-</sup> | 3.376       | H7  | FRA <sup>-</sup>  | 1.117       |
| D8  | OUT1B <sup>+</sup> | 1.850       | K10 | OUT6A <sup>+</sup>            | 1.865       | G2  | A <sub>IN4</sub> <sup>+</sup> | 3.372       | H8  | FRA <sup>+</sup>  | 1.038       |
| B8  | OUT2A <sup>-</sup> | 3.233       | L9  | OUT6B <sup>-</sup>            | 2.268       | H2  | A <sub>IN5</sub> <sup>-</sup> | 3.301       | J9  | FRB <sup>-</sup>  | 1.644       |
| A8  | OUT2A <sup>+</sup> | 3.246       | L10 | OUT6B <sup>+</sup>            | 2.267       | H1  | A <sub>IN5</sub> <sup>+</sup> | 3.346       | J10 | FRB <sup>+</sup>  | 1.643       |
| D7  | OUT2B <sup>-</sup> | 0.179       | M7  | OUT7A <sup>-</sup>            | 1.089       | K2  | A <sub>IN6</sub> <sup>-</sup> | 2.506       | A7  | PAR/SER           | 3.838       |
| C7  | OUT2B <sup>+</sup> | 1.127       | L7  | OUT7A <sup>+</sup>            | 0.179       | K1  | A <sub>IN6</sub> <sup>+</sup> | 2.533       | L6  | SCK               | 0.240       |
| D10 | OUT3A <sup>-</sup> | 2.126       | P8  | OUT7B <sup>-</sup>            | 3.281       | M2  | A <sub>IN7</sub> <sup>-</sup> | 3.198       | E6  | SDOA              | 0.453       |
| D9  | OUT3A <sup>+</sup> | 2.177       | N8  | OUT7B <sup>+</sup>            | 3.149       | M1  | A <sub>IN7</sub> <sup>+</sup> | 3.214       | D6  | SDOB              | 0.274       |
| E10 | OUT3B <sup>-</sup> | 1.811       | L8  | OUT8A <sup>-</sup>            | 1.862       | N2  | A <sub>IN8</sub> <sup>-</sup> | 4.726       | M6  | SDI               | 1.069       |
| E9  | OUT3B <sup>+</sup> | 1.812       | M8  | OUT8A <sup>+</sup>            | 1.847       | N1  | A <sub>IN8</sub> <sup>+</sup> | 4.691       | B3  | V <sub>CM14</sub> | 3.914       |
| C9  | OUT4A <sup>-</sup> | 3.199       | M10 | OUT8B <sup>-</sup>            | 4.021       | P6  | ENC <sup>-</sup>              | 4.106       | F3  | V <sub>CM23</sub> | 0.123       |
| C10 | OUT4A <sup>+</sup> | 3.196       | M9  | OUT8B <sup>+</sup>            | 4.016       | P5  | ENC <sup>+</sup>              | 4.106       | J3  | V <sub>CM67</sub> | 0.079       |
| F7  | OUT4B <sup>-</sup> | 0.706       | B1  | A <sub>IN1</sub> <sup>-</sup> | 4.689       | L5  | C <sub>SA</sub>               | 0.919       | N3  | V <sub>CM58</sub> | 3.915       |
| F8  | OUT4B <sup>+</sup> | 0.639       | B2  | A <sub>IN1</sub> <sup>+</sup> | 4.709       | M5  | C <sub>SB</sub>               | 1.162       |     |                   |             |
| J8  | OUT5A <sup>-</sup> | 0.392       | C1  | A <sub>IN2</sub> <sup>-</sup> | 4.724       | G8  | DCOA <sup>-</sup>             | 1.157       |     |                   |             |
| J7  | OUT5A <sup>+</sup> | 0.436       | C2  | A <sub>IN2</sub> <sup>+</sup> | 4.769       | G7  | DCOA <sup>+</sup>             | 1.088       |     |                   |             |



# TYPICAL APPLICATIONS

## Silkscreen Top

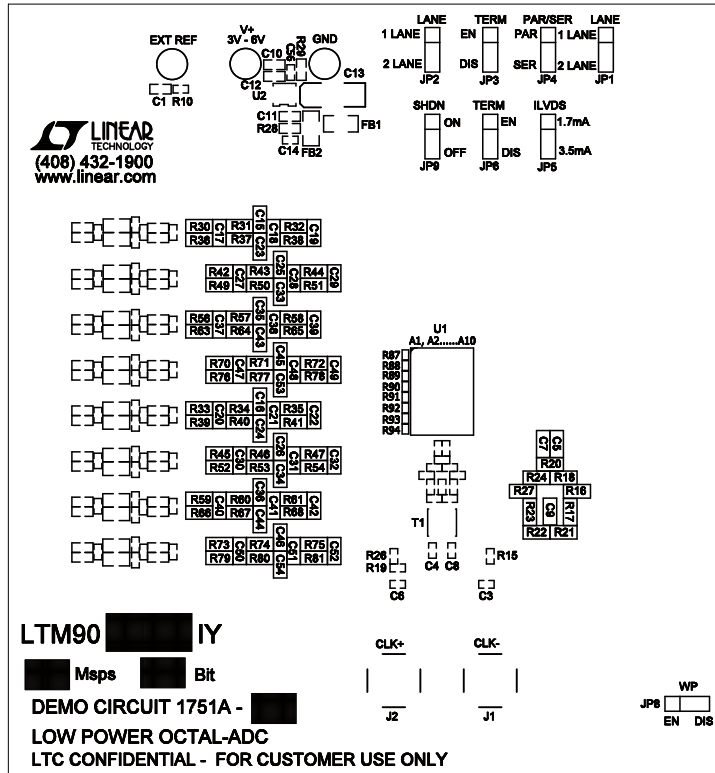

## Top Side

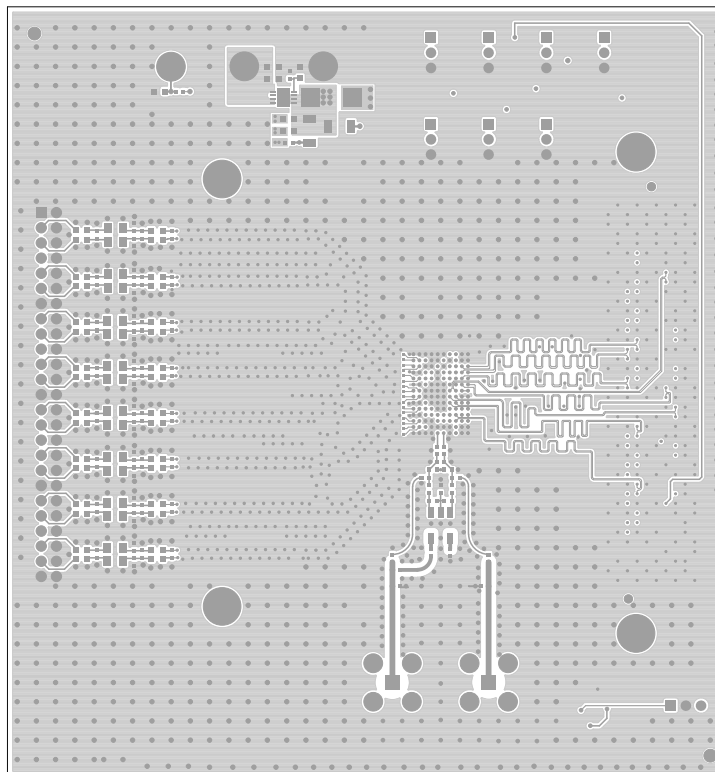

# TYPICAL APPLICATIONS

Inner Layer 2

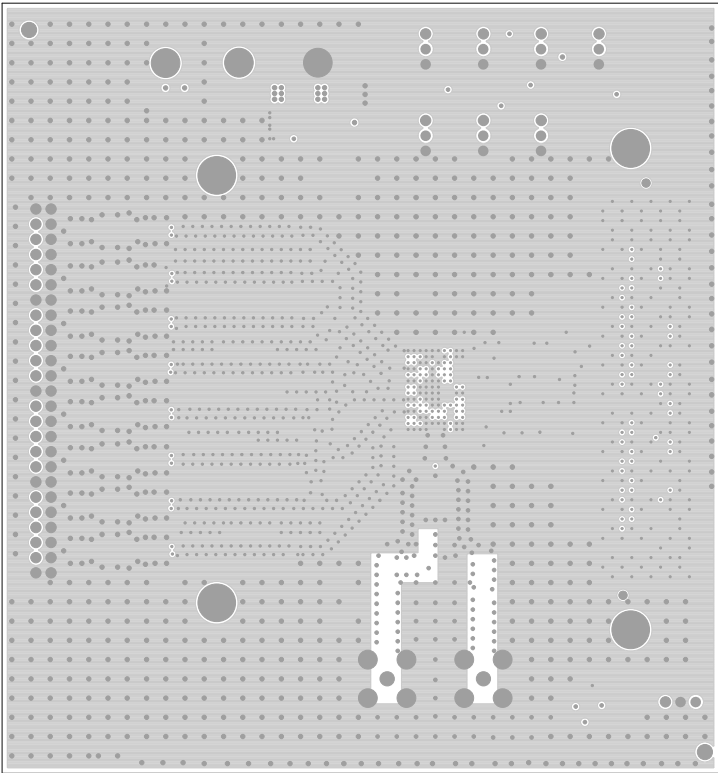

Inner Layer 3

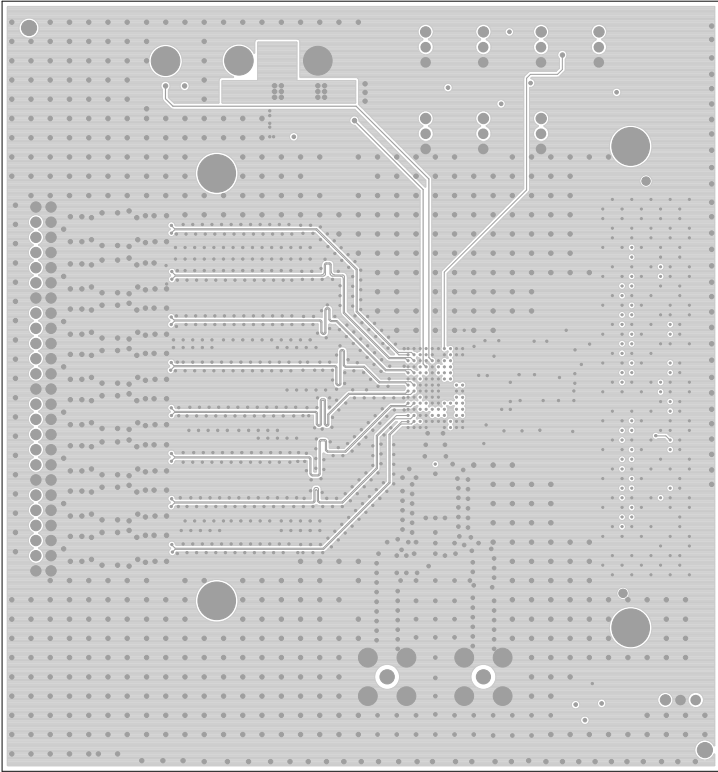

## TYPICAL APPLICATIONS

Inner Layer 4

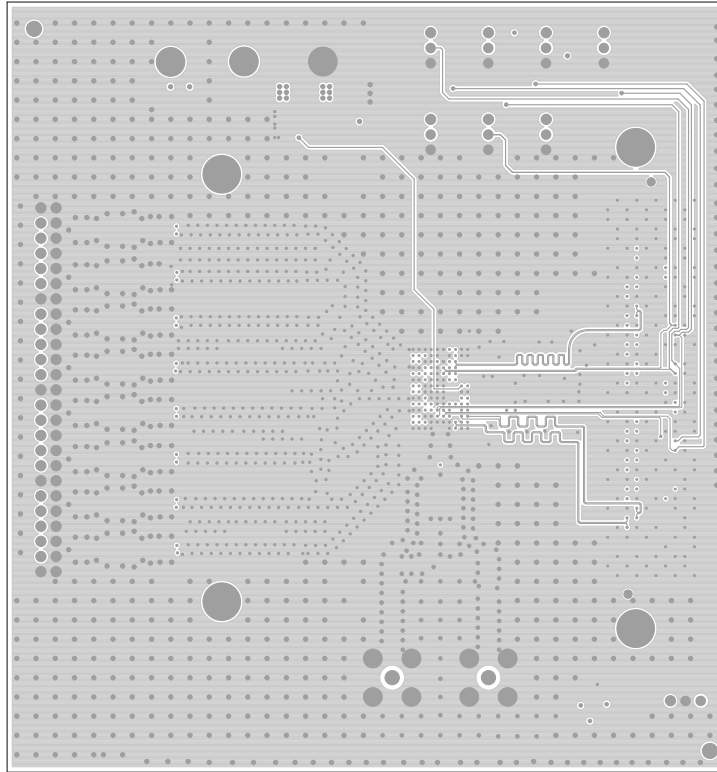

Inner Layer 5

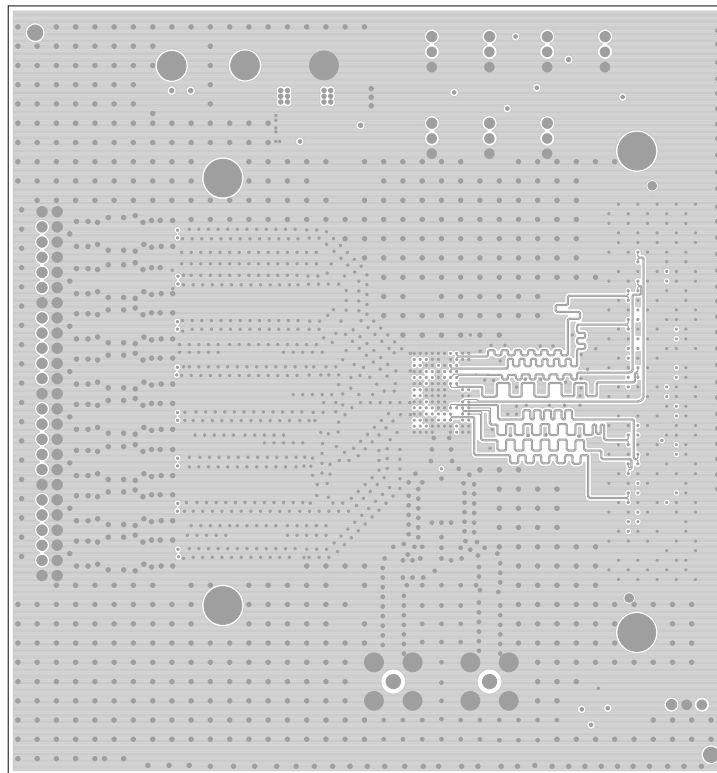

# TYPICAL APPLICATIONS

Bottom Side

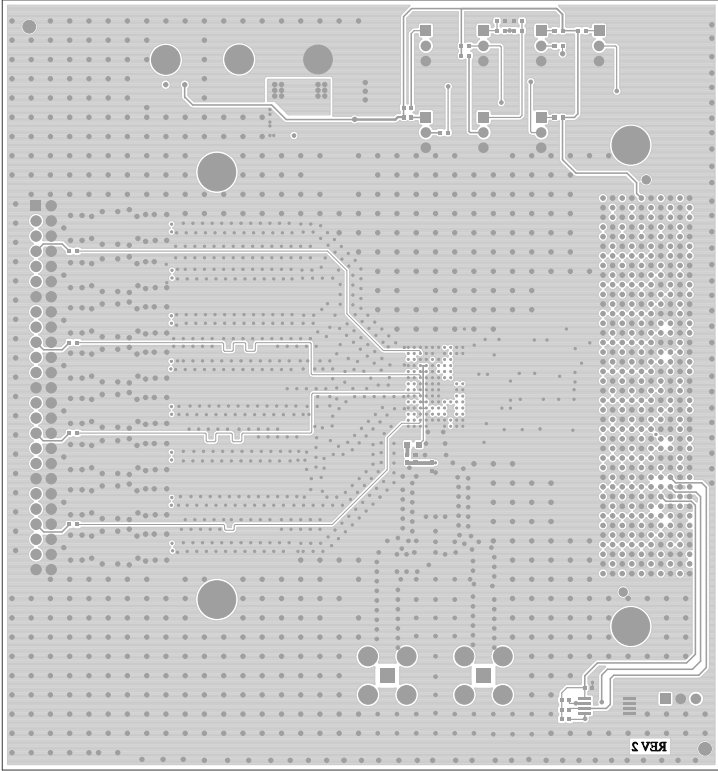

Silkscreen Bottom

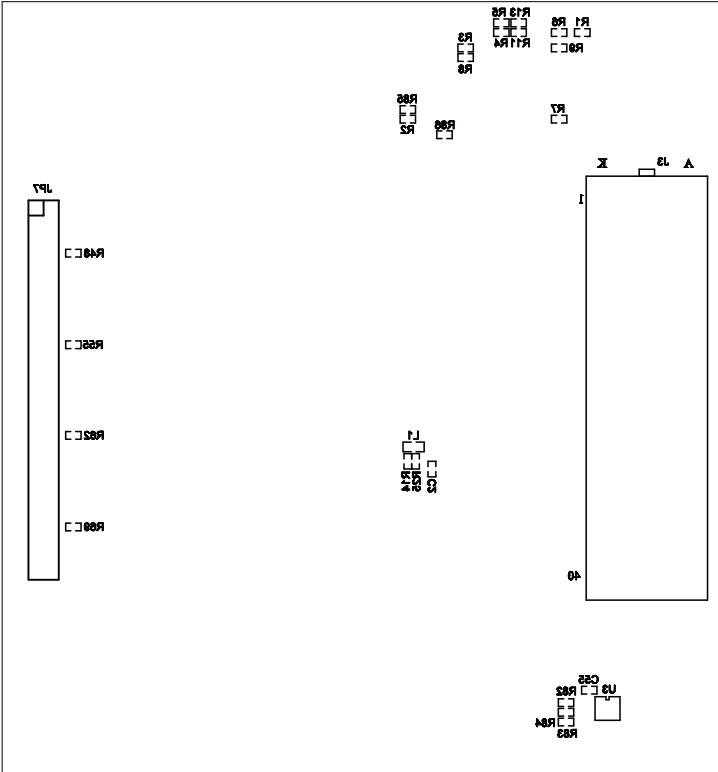



# LTM9011-14/ LTM9010-14/LTM9009-14

## PACKAGE DESCRIPTION

Please refer to <http://www.linear.com/product/LTM9011-14#packaging> for the most recent package drawings.

**BGA Package**  
**140-Lead (11.25mm × 9.00mm × 2.72mm)**  
(Reference LTC DWG # 05-08-1849 Rev C)

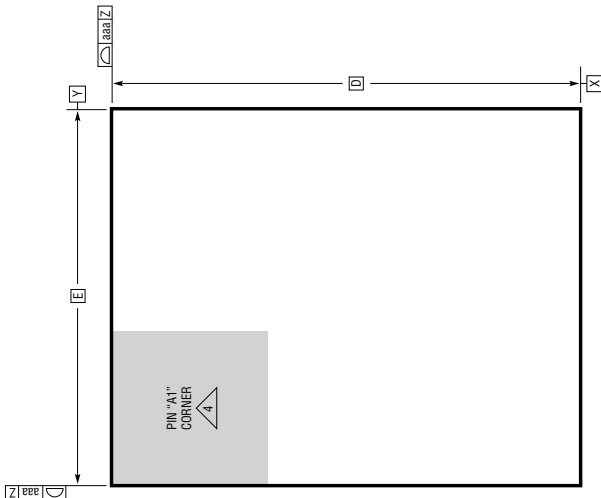
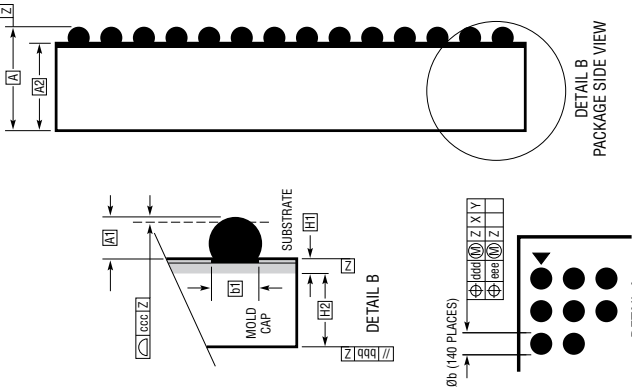
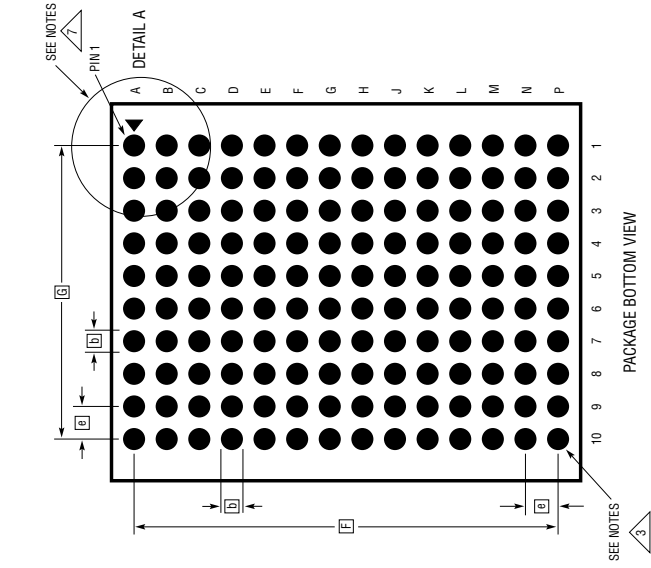

- NOTES:
1. DIMENSIONING AND TOLERANCING PER ASME Y14.5M-1994
  2. ALL DIMENSIONS ARE IN MILLIMETERS
  3. BALL DESIGNATION PER JEDEC MS-028 AND JEP95
  4. DETAILS OF PIN #1 IDENTIFIER ARE OPTIONAL BUT MUST BE LOCATED WITHIN THE ZONE INDICATED. THE PIN #1 IDENTIFIER MAY BE EITHER A MOLD OR MARKED FEATURE
  5. PRIMARY DATUM -Z- IS SEATING PLANE
  6. SOLDER BALL COMPOSITION CAN BE 96.5% Sn/3.0% Ag/0.5% Cu OR Sn/Pb EUTECTIC
  7. PACKAGE ROW AND COLUMN LABELING MAY VARY AMONG μModule PRODUCTS. REVIEW EACH PACKAGE LAYOUT CAREFULLY

| SYMBOL                     | DIMENSIONS |      | NOTES |
|----------------------------|------------|------|-------|
|                            | MIN        | NOM  |       |
| A                          | 2.57       | 2.72 | 2.87  |
| A1                         | 0.35       | 0.40 | 0.45  |
| A2                         | 2.22       | 2.32 | 2.42  |
| b                          | 0.45       | 0.50 | 0.55  |
| b1                         | 0.37       | 0.40 | 0.43  |
| D                          | 11.25      |      |       |
| E                          | 9.0        |      |       |
| e                          | 0.80       |      |       |
| F                          | 10.40      |      |       |
| G                          | 7.2        |      |       |
| H1                         | 0.27       | 0.32 | 0.37  |
| H2                         | 1.95       | 2.00 | 2.05  |
| aaa                        | 0.15       |      |       |
| bbb                        | 0.10       |      |       |
| ccc                        | 0.12       |      |       |
| ddd                        | 0.15       |      |       |
| eee                        | 0.08       |      |       |
| TOTAL NUMBER OF BALLS: 140 |            |      |       |

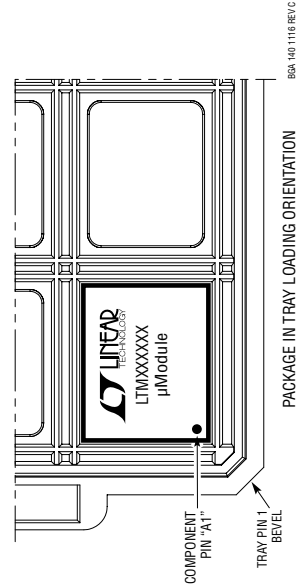
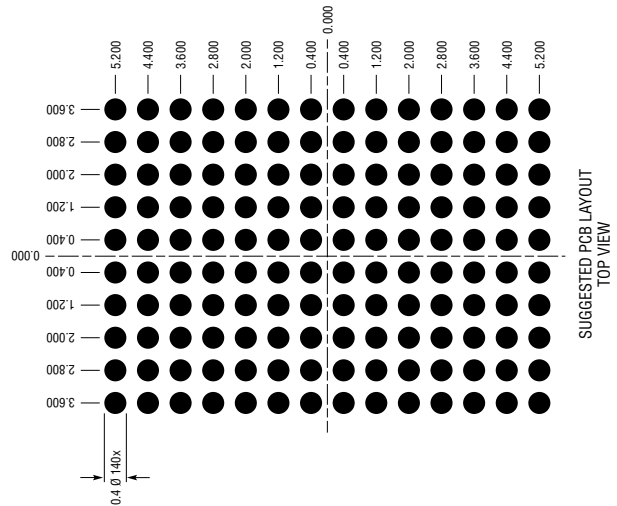

## REVISION HISTORY

| REV | DATE | DESCRIPTION   | PAGE NUMBER                                 |
|-----|------|---|---|
| A   | 9/11 | Updated Functional Block Diagram.   | 21  |
| B   | 3/15 | Removed mention of OGND.  | 26  |
| C   | 2/17 | Fixed $V_{CM}$ channel pairs: $V_{CM12}$ changed to $V_{CM14}$ , $V_{CM34}$ changed to $V_{CM23}$ , $V_{CM56}$ changed to $V_{CM67}$ , $V_{CM78}$ changed to $V_{CM58}$ .<br>Corrected pin names for ENC and OUTXX. | 18, 20, 21, 32,<br>37, 40<br>20, 32, 37, 40 |
| D   | 4/18 | Corrected J3/N3 pin names.  | 20  |

## TYPICAL APPLICATION

Single-Ended to Differential Conversion Using LTC6409 and 50MHz Lowpass Filter (Only One Channel Shown).  
Filter for Use at 92.16MSPs

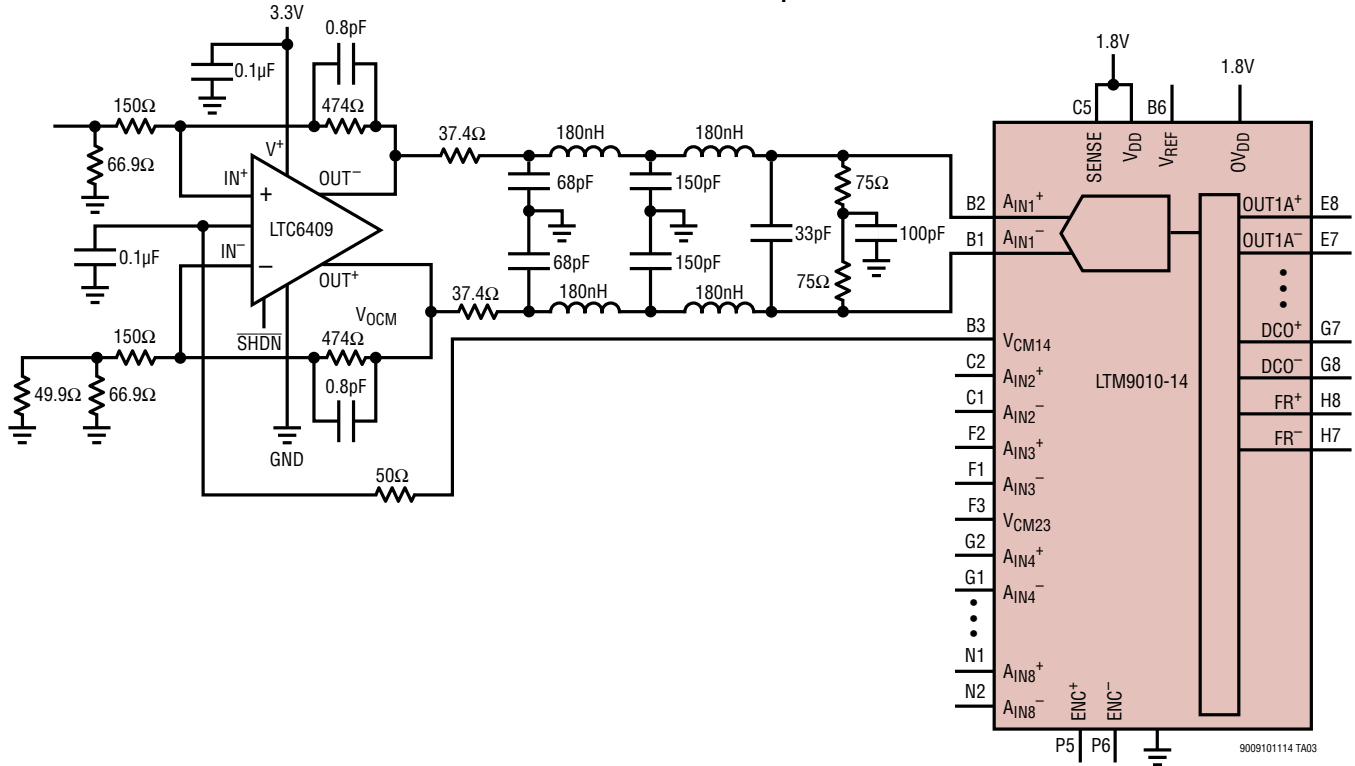

## RELATED PARTS

| PART NUMBER                                      | DESCRIPTION  | COMMENTS  |
|--|--|---|
| <b>ADCs</b>                                      |  |   |
| <a href="#">LTC2170-14/LTC2171-14/LTC2172-14</a> | 14-Bit, 25Msps/40Msps/65Msps 1.8V Quad ADCs, Ultralow Power                  | 178mW/234mW/360mW, 73.4dB SNR, 85dB SFDR, Serial LVDS Outputs, 7mm × 8mm QFN-52                           |
| <a href="#">LTC2170-12/LTC2171-12/LTC2172-12</a> | 12-Bit, 25Msps/40Msps/65Msps 1.8V Quad ADCs, Ultralow Power                  | 178mW/234mW/360mW, 70.5dB SNR, 85dB SFDR, Serial LVDS Outputs, 7mm × 8mm QFN-52                           |
| <a href="#">LTC2173-12/LTC2174-12/LTC2175-12</a> | 12-Bit, 80Msps/105Msps/125Msps 1.8V Quad ADCs, Ultralow Power                | 412mW/481mW/567mW, 70.5dB SNR, 85dB SFDR, Serial LVDS Outputs, 7mm × 8mm QFN-52                           |
| <a href="#">LTC2173-14/LTC2174-14/LTC2175-14</a> | 14-Bit, 80Msps/105Msps/125Msps 1.8V Quad ADCs, Ultralow Power                | 412mW/481mW/567mW, 73.4dB SNR, 85dB SFDR, Serial LVDS Outputs, 7mm × 8mm QFN-52                           |
| <b>Amplifiers/Filters</b>                        |  |   |
| <a href="#">LTC6412</a>                          | 800MHz, 31dB Range, Analog-Controlled Variable Gain Amplifier                | Continuously Adjustable Gain Control, 35dBm OIP3 at 240MHz, 10dB Noise Figure, 4mm × 4mm QFN-24           |
| <a href="#">LTC6420-20</a>                       | 1.8GHz Dual Low Noise, Low Distortion Differential ADC Drivers for 300MHz IF | Fixed Gain 10V/V, 1nV/√Hz Total Input Noise, 80mA Supply Current per Amplifier, 3mm × 4mm QFN-20          |
| <a href="#">LTC6421-20</a>                       | 1.3GHz Dual Low Noise, Low Distortion Differential ADC Drivers               | Fixed Gain 10V/V, 1nV/√Hz Total Input Noise, 40mA Supply Current per Amplifier, 3mm × 4mm QFN-20          |
| <a href="#">LTC6605-7/LTC6605-10/LTC6605-14</a>  | Dual Matched 7MHz/10MHz/14MHz Filters with ADC Drivers                       | Dual Matched 2nd Order Lowpass Filters with Differential Drivers, Pin-Programmable Gain, 6mm × 3mm DFN-22 |
| <b>Signal Chain Receivers</b>                    |  |   |
| <a href="#">LTM9002</a>                          | 14-Bit Dual Channel IF/Baseband Receiver Subsystem                           | Integrated High Speed ADC, Passive Filters and Fixed Gain Differential Amplifiers                         |