



GaAs pHEMT MMIC LOW NOISE HIGH IP3 AMPLIFIER, 12 - 16 GHz

Typical Applications

The HMC490LP5(E) is ideal for:

- Point-to-Point Radios
- Point-to-Multi-Point Radios
- VSAT
- Military EW, ECM & C³I

Features

- Noise Figure: 2.5 dB
- P1dB Output Power: +25 dBm
- Gain: 23 dB
- Output IP3: +34 dBm
- +5V Supply
- 50 Ohm Matched Input/Output
- 32 Lead 5x5mm SMT Package: 25mm²

Functional Diagram

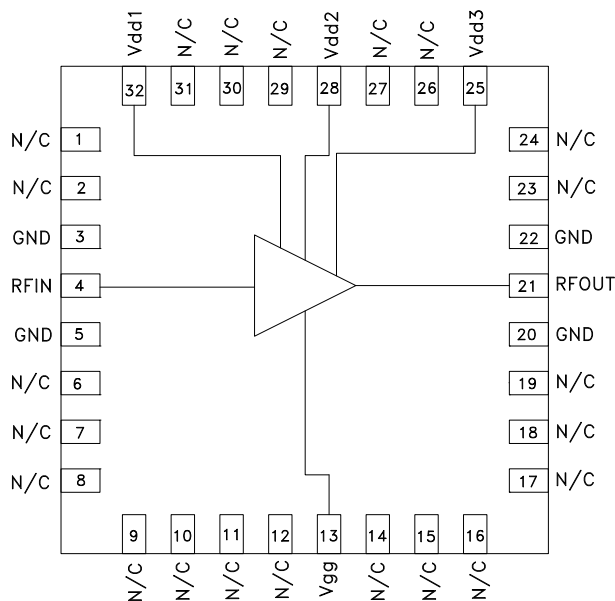

General Description

The HMC490LP5(E) is a high dynamic range GaAs pHEMT MMIC Low Noise Amplifier which operates between 12 and 16 GHz. The HMC490LP5(E) provides 23 dB of gain, 2.5 dB noise figure and an output IP3 of +34 dBm from a +5V supply voltage. This versatile amplifier combines excellent, stable +25 dBm P1dB output power with very low noise figure making it ideal for receive and transmit applications. The amplifier is packaged in a leadless 5x5 mm QFN surface mount package.

Electrical Specifications, $T_A = +25^\circ\text{C}$, $V_{dd} = 5\text{V}$, $I_{dd} = 200\text{mA}^*$

Parameter	Min.	Typ.	Max.	Units
Frequency Range	12 - 16			GHz
Gain	20	23		dB
Gain Variation Over Temperature		0.03	0.04	dB/°C
Noise Figure		2.5	3.5	dB
Input Return Loss		8		dB
Output Return Loss		8		dB
Output Power for 1 dB Compression (P1dB)	22	25		dBm
Saturated Output Power (P _{sat})		27		dBm
Output Third Order Intercept (IP3)		34		dBm
Supply Current (I _{dd})(V _{dd} = 5V, V _{gg} = -0.8V Typ.)		200		mA

* Adjust V_{gg} between -2 to 0V to achieve I_{dd} = 200 mA typical.



GaAs pHEMT MMIC LOW NOISE HIGH IP3 AMPLIFIER, 12 - 16 GHz

Broadband Gain & Return Loss

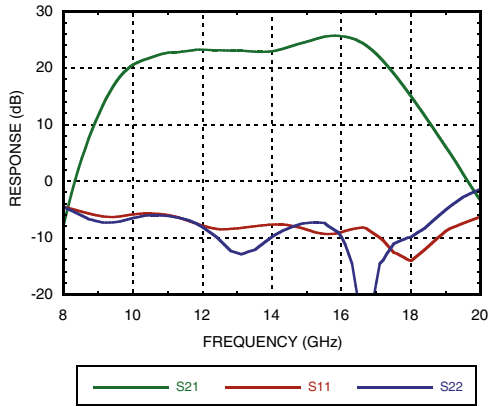

Gain vs. Temperature

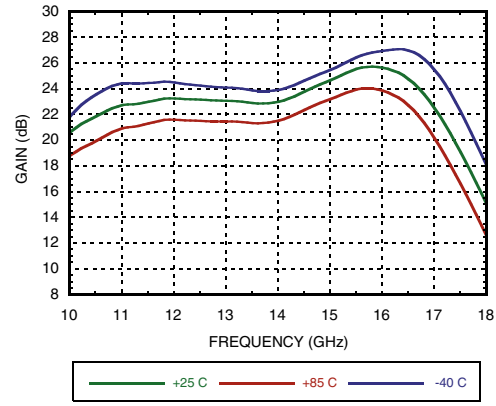

Input Return Loss vs. Temperature

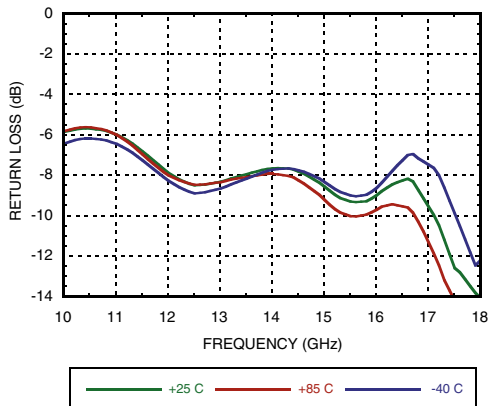

Output Return Loss vs. Temperature

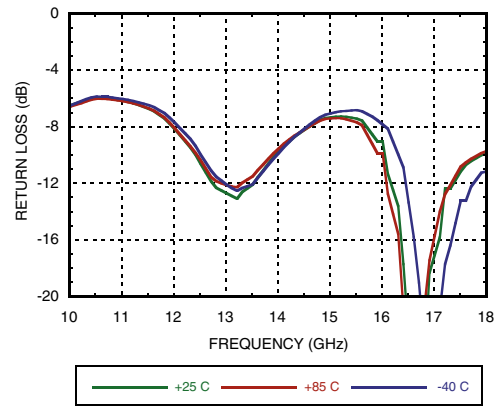

Noise Figure vs. Temperature

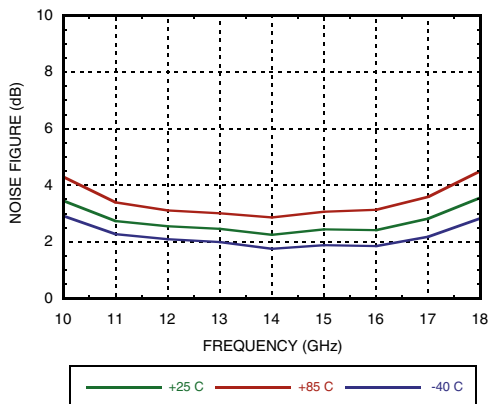

Output IP3 vs. Temperature

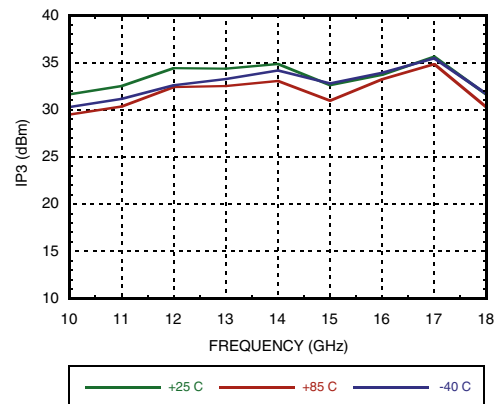

Information furnished by Analog Devices is believed to be accurate and reliable. However, no responsibility is assumed by Analog Devices for its use, nor for any infringements of patents or other rights of third parties that may result from its use. Specifications subject to change without notice. No license is granted by implication or otherwise under any patent or patent rights of Analog Devices. Trademarks and registered trademarks are the property of their respective owners.

For price, delivery, and to place orders: Analog Devices, Inc., One Technology Way, P.O. Box 9106, Norwood, MA 02062-9106 Phone: 781-329-4700 • Order online at www.analog.com Application Support: Phone: 1-800-ANALOG-D



GaAs pHEMT MMIC LOW NOISE HIGH IP3 AMPLIFIER, 12 - 16 GHz

LOW NOISE AMPLIFIER - SMT

P1dB vs. Temperature

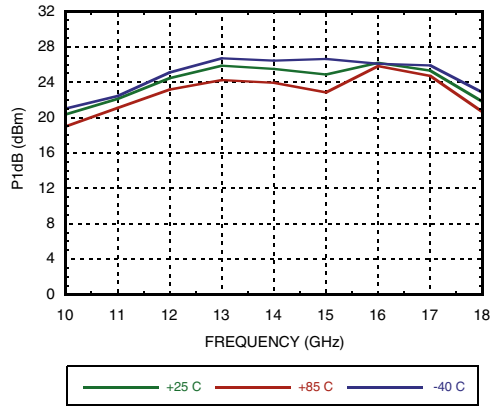

Psat vs. Temperature

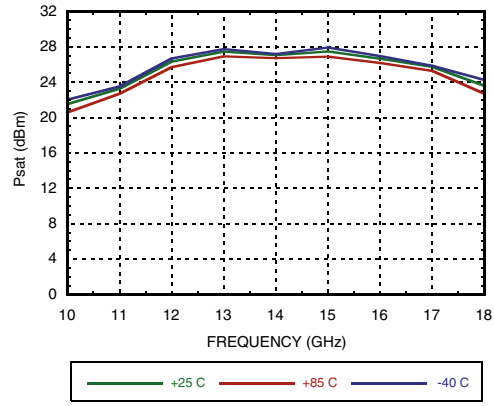

Gain, Noise Figure & OIP3 vs. Supply Voltage @ 14 GHz, I_{dd}= 200 mA

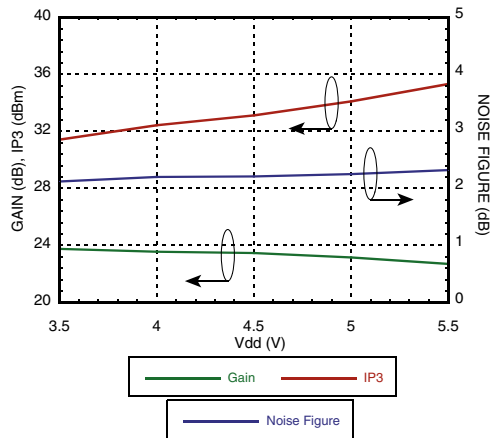

Power Compression @ 14 GHz

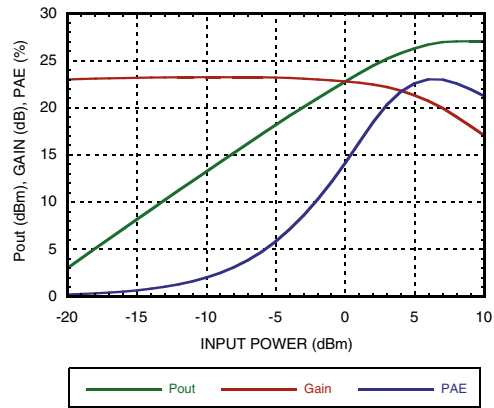

Gain, Noise Figure & IP3 vs. Supply Current @ 14 GHz, V_{dd}= 5V*

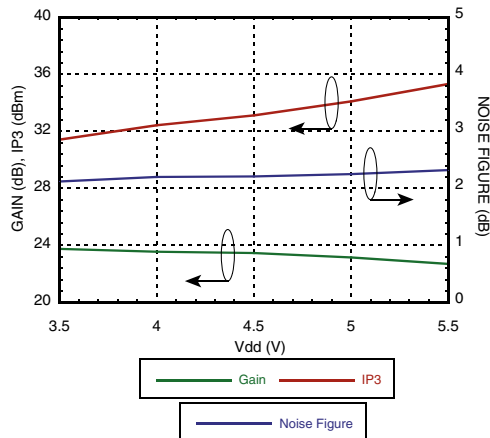

Power Dissipation

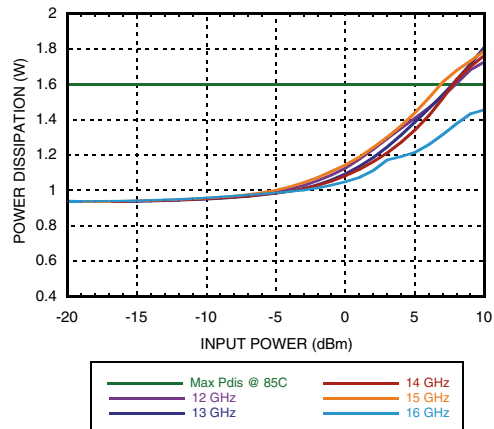

* I_{dd} is controlled by varying V_{gg}

Information furnished by Analog Devices is believed to be accurate and reliable. However, no responsibility is assumed by Analog Devices for its use, nor for any infringements of patents or other rights of third parties that may result from its use. Specifications subject to change without notice. No license is granted by implication or otherwise under any patent or patent rights of Analog Devices. Trademarks and registered trademarks are the property of their respective owners.

For price, delivery, and to place orders: Analog Devices, Inc., One Technology Way, P.O. Box 9106, Norwood, MA 02062-9106 Phone: 781-329-4700 • Order online at www.analog.com Application Support: Phone: 1-800-ANALOG-D

GaAs pHEMT MMIC LOW NOISE HIGH IP3 AMPLIFIER, 12 - 16 GHz



Reverse Isolation vs. Temperature

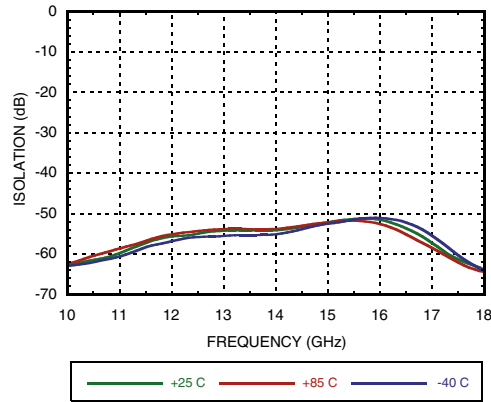

Absolute Maximum Ratings

Drain Bias Voltage (Vdd1, Vdd2, Vdd3)	+5.5V
Gate Bias Voltage (Vgg)	-4 to 0V
RF Input Power (RFIN)(Vdd = +5V)	+10 dBm
Channel Temperature	175 °C
Continuous Pdiss (T = 85 °C) (derate 17.9 mW/°C above 85 °C)	1.6 W
Thermal Resistance (channel to ground paddle)	56 °C/W
Storage Temperature	-65 to +150 °C
Operating Temperature	-40 to +85 °C

Typical Supply Current vs. Vdd

Vdd (V)	Idd (mA)
+3.0	140
+3.5	154
+4.0	168
+4.5	188
+5.0	200
+5.5	208

Note: Amplifier will operate over full voltage ranges shown above.



**ELECTROSTATIC SENSITIVE DEVICE
OBSERVE HANDLING PRECAUTIONS**



GaAs pHEMT MMIC LOW NOISE HIGH IP3 AMPLIFIER, 12 - 16 GHz

Outline Drawing

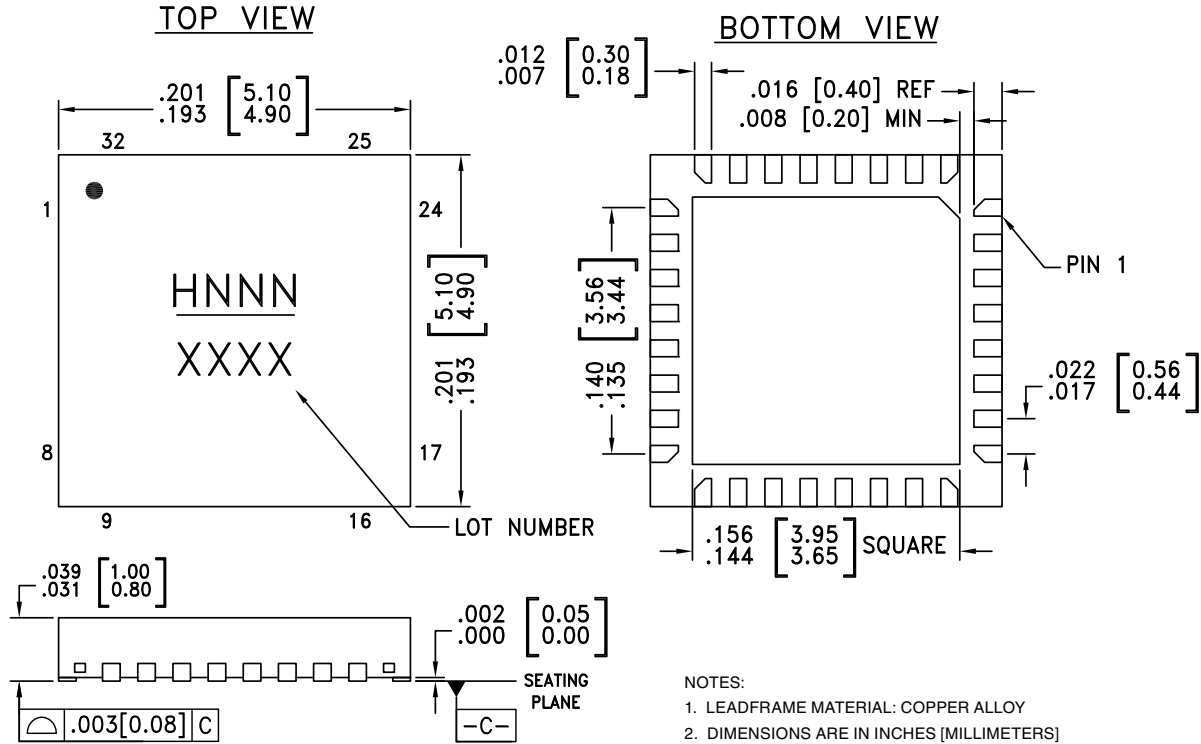

- NOTES:
1. LEADFRAME MATERIAL: COPPER ALLOY
 2. DIMENSIONS ARE IN INCHES [MILLIMETERS]
 3. LEAD SPACING TOLERANCE IS NON-CUMULATIVE.
 4. PAD BURR LENGTH SHALL BE 0.15mm MAXIMUM.
PAD BURR HEIGHT SHALL BE 0.05mm MAXIMUM.
 5. PACKAGE WARP SHALL NOT EXCEED 0.05mm.
 6. ALL GROUND LEADS AND GROUND PADDLE MUST BE SOLDERED TO PCB RF GROUND.
 7. REFER TO HITTITE APPLICATION NOTE FOR SUGGESTED LAND PATTERN.

Package Information

Part Number	Package Body Material	Lead Finish	MSL Rating	Package Marking ^[3]
HMC490LP5	Low Stress Injection Molded Plastic	Sn/Pb Solder	MSL1 ^[1]	H490 XXXX
HMC490LP5E	RoHS-compliant Low Stress Injection Molded Plastic	100% matte Sn	MSL1 ^[2]	H490 XXXX

[1] Max peak reflow temperature of 235 °C
 [2] Max peak reflow temperature of 260 °C
 [3] 4-Digit lot number XXXX



GaAs pHEMT MMIC LOW NOISE HIGH IP3 AMPLIFIER, 12 - 16 GHz

Pin Descriptions

Pin Number	Function	Description	Interface Schematic
1, 2, 6 - 12, 14 - 19, 23, 24, 26, 27, 29 - 31	N/C	The pins are not connected internally; however, all data shown herein was measured with these pins connected to RF/DC ground externally.	
3, 5, 20, 22	GND	Package bottom must also be connected to RF/DC ground.	
4	RFIN	This pad is AC coupled and matched to 50 Ohms.	
13	Vgg	Gate control for amplifier. Adjust to achieve I _{dd} of 200 mA. Please follow "MMIC Amplifier Biasing Procedure" Application Note. External bypass capacitors of 100 pF and 0.01 μF are required.	
21	RFOUT	This pad is AC coupled and matched to 50 Ohms.	
25, 28, 32	Vdd3, 2, 1	Power Supply Voltage for the amplifier. External bypass capacitors of 100 pF and 0.01 μF are required.	

Application Circuit

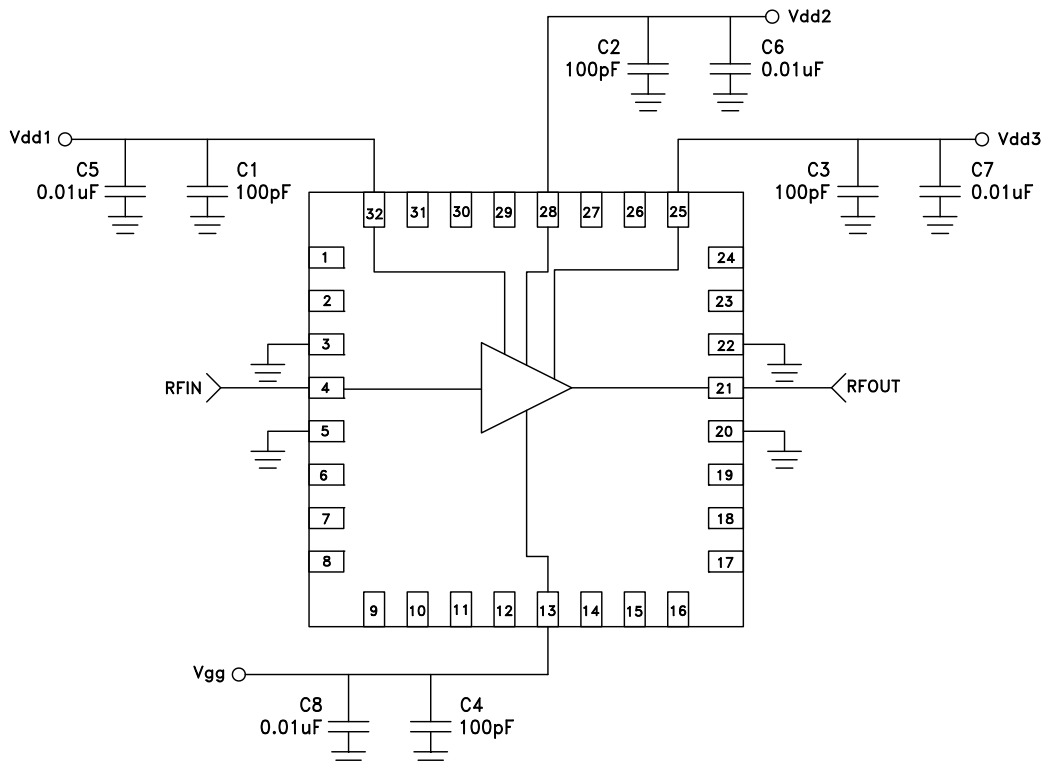

Information furnished by Analog Devices is believed to be accurate and reliable. However, no responsibility is assumed by Analog Devices for its use, nor for any infringements of patents or other rights of third parties that may result from its use. Specifications subject to change without notice. No license is granted by implication or otherwise under any patent or patent rights of Analog Devices. Trademarks and registered trademarks are the property of their respective owners.

For price, delivery, and to place orders: Analog Devices, Inc., One Technology Way, P.O. Box 9106, Norwood, MA 02062-9106 Phone: 781-329-4700 • Order online at www.analog.com Application Support: Phone: 1-800-ANALOG-D



**GaAs pHEMT MMIC LOW NOISE
HIGH IP3 AMPLIFIER, 12 - 16 GHz**

Evaluation PCB

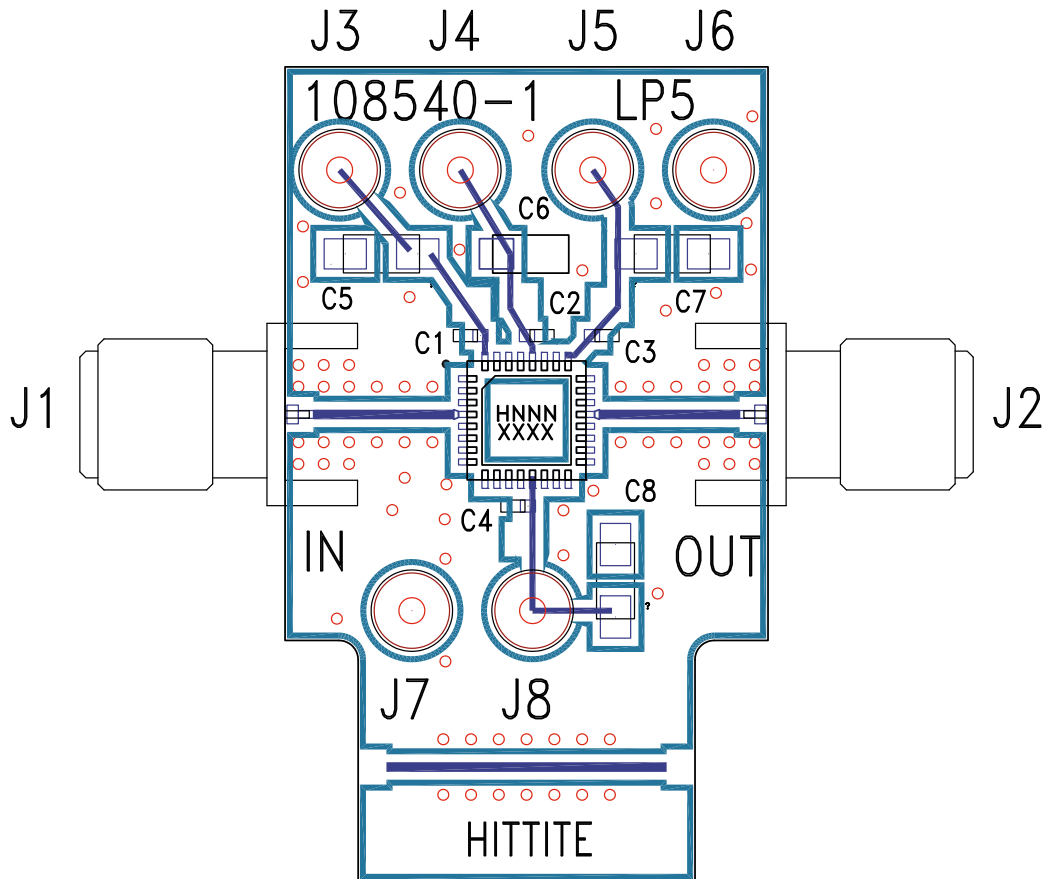

List of Materials for Evaluation PCB 108402 [1]

Item	Description
J1 - J2	PCB Mount SMA Connector
J3 - J8	DC Pin
C1 - C4	1000 pF Capacitor, 0402 Pkg.
C5 - C8	4.7 μ F Capacitor, Tantalum
U1	HMC490LP5 / HMC490LP5E
PCB [2]	108540 Evaluation PCB

[1] Reference this number when ordering complete evaluation PCB

[2] Circuit Board Material: Rogers 4350

The circuit board used in the application should use RF circuit design techniques. Signal lines should have 50 Ohm impedance while the package ground leads and package bottom should be connected directly to the ground plane similar to that shown. A sufficient number of via holes should be used to connect the top and bottom ground planes. The evaluation board should be mounted to an appropriate heat sink. The evaluation circuit board shown is available from Hittite upon request.

**Notes:****HMC490LP5 / 490LP5E**

v04.0213

**GaAs pHEMT MMIC LOW NOISE
HIGH IP3 AMPLIFIER, 12 - 16 GHz**