

DFN-6 to DIP-6 SMT Adapter (0.5 mm pitch, 1.6 x 1.6 mm body)

REF.	DIMENSIONS					
	mm			inches		
	MIN.	TYP.	MAX.	MIN.	TYP.	MAX.
A		0.60				
B		0.70				
C		0.25				
D		0.25				
E		0.50				
F					0.300	
G					0.100	
H					0.025	

Top View (SMT Footprint)

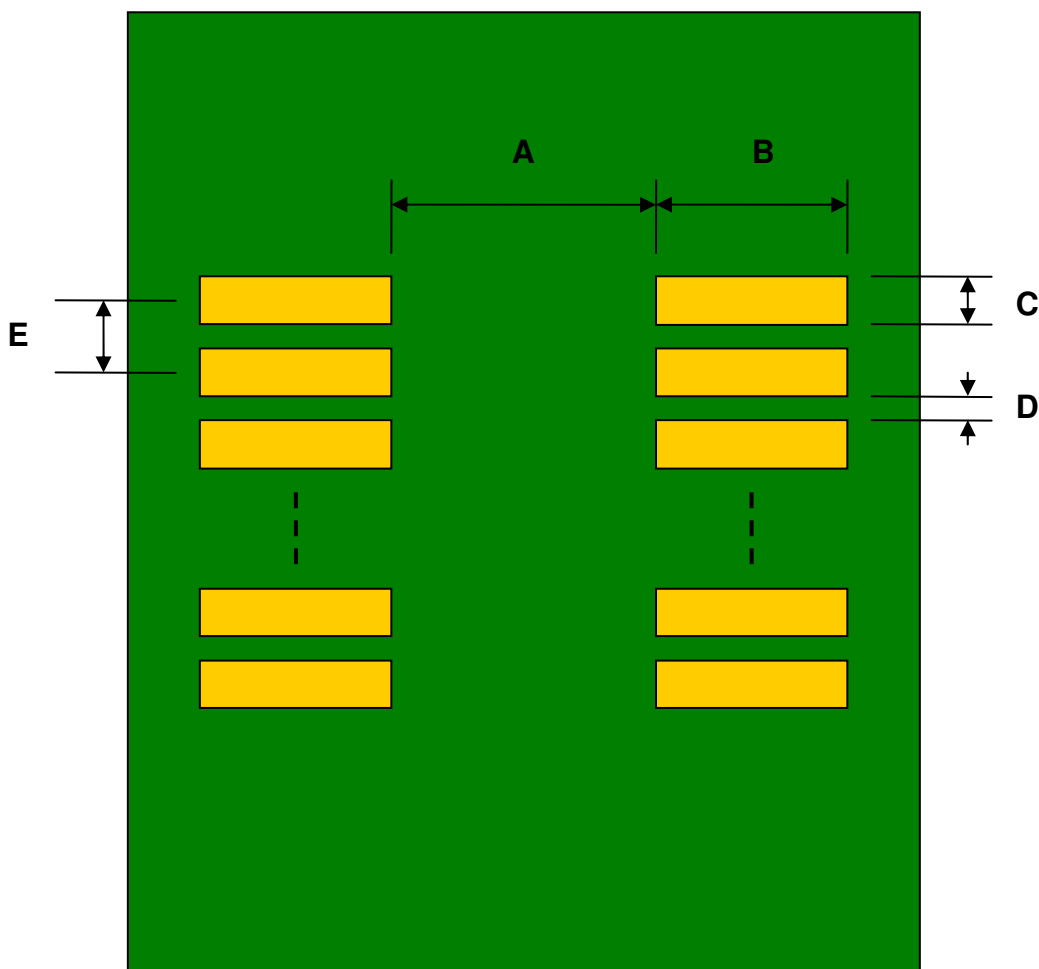

(Representative drawing only - not to scale)

Bottom View (DIP Pins)

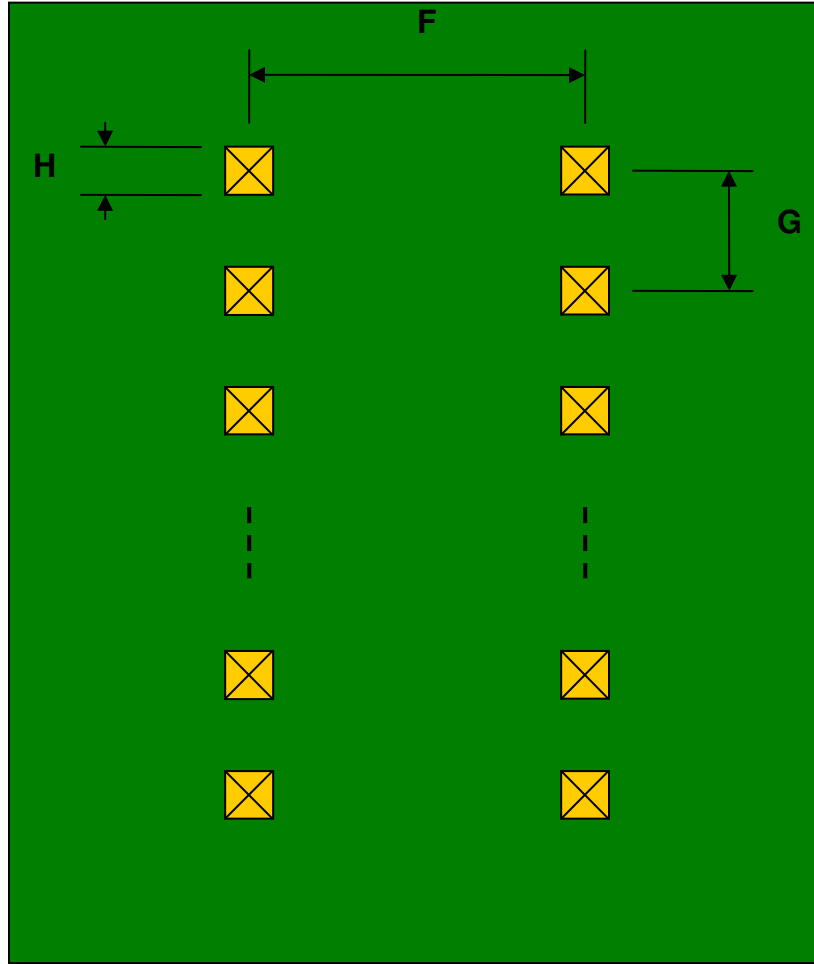

(Representative drawing only - not to scale)

Side View (DIP Pins)

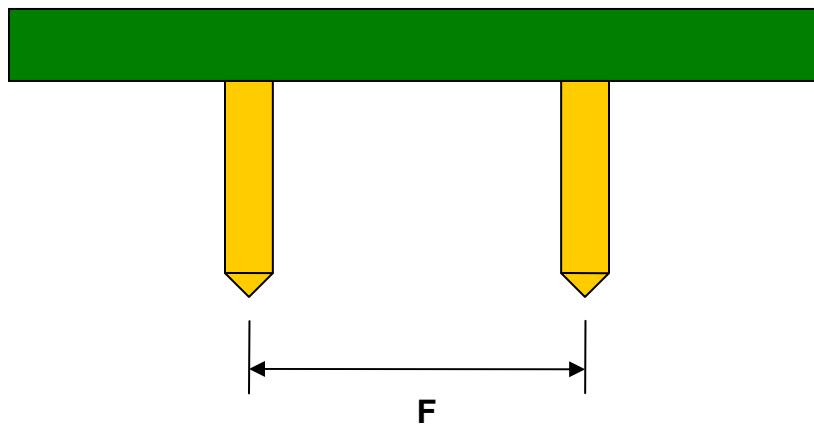

(Representative drawing only - not to scale)