

Features

- Low current rectification and high speed switching.
- Extremely small surface mount type.
- Low forward voltage drop.
- Silicon epitaxial planar chip, metal silicon junction.
- Lead-free parts for green partner, exceeds environmental standards of MIL-STD-19500 /228
- Compliant to Halogen-free

Mechanical data

- Epoxy:UL94-V0 rated flame retardant
- Case : Molded plastic, SOD-323
- Terminals : Solder plated, solderable per MIL-STD-750, Method 2026
- Polarity : Indicated by cathode band
- Mounting Position : Any

Package outline

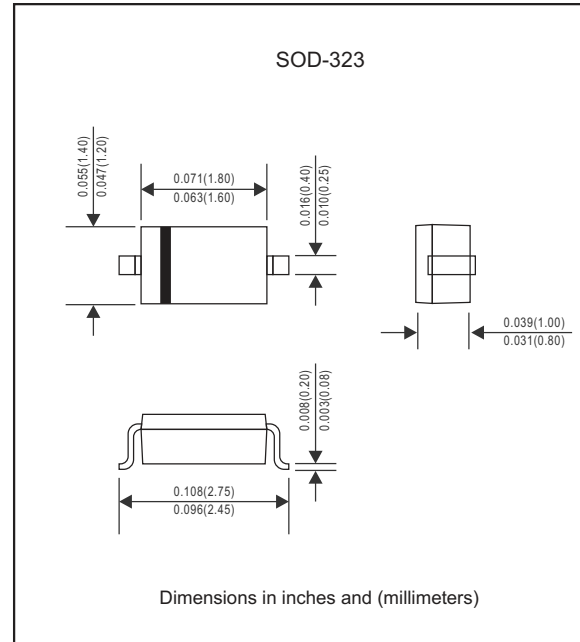

Maximum ratings (AT $T_A=25^\circ\text{C}$ unless otherwise noted)

PARAMETER	CONDITIONS	Symbol	SD103AWS	SD103BWS	SD103CWS	UNIT
Peak repetitive reverse voltage		V_{RRM}	40	30	20	V
Working peak reverse voltage		V_{RWM}				
DC blocking voltage		V_R				
RMS reverse voltage		$V_{R(RMS)}$	28	21	14	V
Average rectified output current		$I_{F(AV)}$	350			mA
Non-repetitive peak forward surge current	@ $t < 1.0s$	I_{FSM}	1.5			A
Total device dissipation		P_D	200			mW
Thermal resistance	Junction to ambient	$R_{\theta JA}$	625			$^\circ\text{C/W}$
Operating temperature		T_J	-55 ~ +125			$^\circ\text{C}$
Storage temperature		T_{STG}	-65 ~ +125			$^\circ\text{C}$

Electrical Characteristics(AT $T_A=25^\circ\text{C}$ unless otherwise noted)

PARAMETER	CONDITIONS	Symbol	MIN.	TYP.	MAX.	UNIT
Reverse breakdown voltage	$I_R = 100\mu\text{A}$, SD103AWS $I_R = 100\mu\text{A}$, SD103BWS $I_R = 100\mu\text{A}$, SD103CWS	$V_{(BR)R}$	40 30 20			V
Forward voltage	$I_F = 20\text{mA}$ $I_F = 200\text{mA}$	V_F			0.37 0.60	V
Reverse current	$V_R = 30\text{V}$, SD103AWS $V_R = 20\text{V}$, SD103BWS $V_R = 10\text{V}$, SD103CWS	I_R			5.0	μA
Typical Junction capacitance	$V_R = 0\text{V}$, $f = 1.0\text{MHz}$	C_J		50		pF
Reverse recover time	$I_F = I_R = 200\text{mA}$, $I_{rr} = 0.1 \times I_R$, $R_L = 100_{\text{OHM}}$	t_{rr}		10		ns

Rating and characteristic curves (SD103AWS / BWS / CWS)

Fig. 1 POWER DERATING CURVE

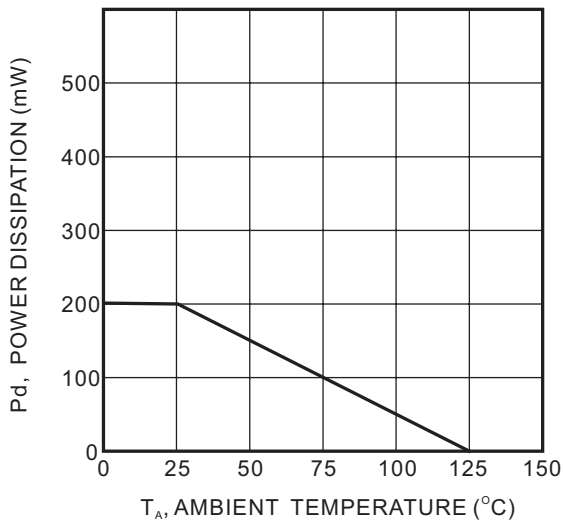

Fig. 2 TYPICAL FORWARD CHARACTERISTIC

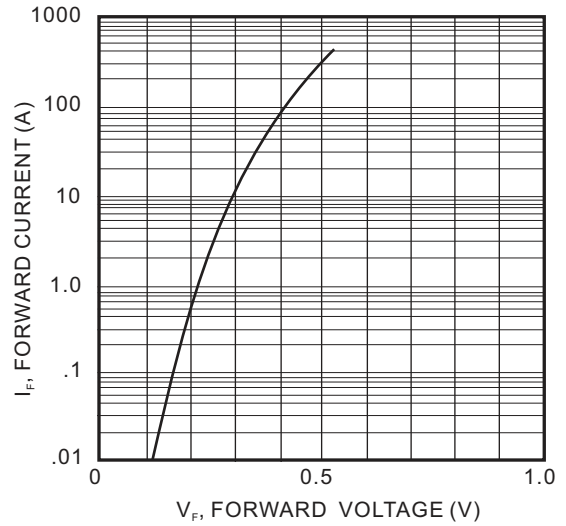
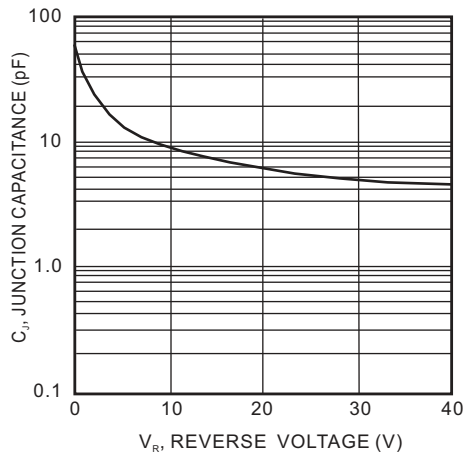



Fig. 3 TYPICAL JUNCTION CAPACITANCE VS REVERSE VOLTAGE



Pinning information

Pin	Simplified outline	Symbol
Pin1 cathode Pin2 anode		

Marking

Type number	Marking code
SD103AWS	S4
SD103BWS	S5
SD103CWS	S6

Suggested solder pad layout

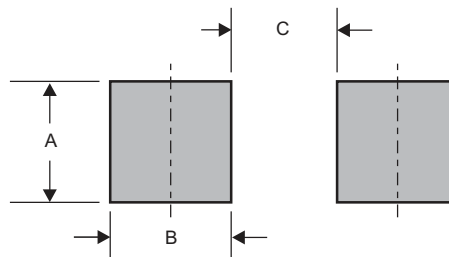

Dimensions in inches and (millimeters)

PACKAGE	A	B	C
SOD-323	0.033 (0.83)	0.025 (0.63)	0.063 (1.60)