

GloTek, Inc. www.globtek.com 186 Veterans Drive, Northvale, NJ 07647 Tel. (201) 784-1000 Fax (201) 784-0111	Drawing Title: TYPE O THAILAND 10A PLUG, 2 PRINGS + GROUND, TIS 166-2549 TYPE, 228B to IEC 60320 C13 DETACHEABLE POWER CONNECTOR, GT Cable #376: 1.0 mm ² / 3 Conductors, 7.0±0.1mm OD, VCT-G or H05VV-F, 70 Deg.C, 500V, BLU/BRN/GRN-YW, Approvals: CCC, H05VVF: IEC 60227, 2500±50mm, GlobTek Black	
	Model No. Power Cord	Part No./Ordering No. 6363762M5701(R)
		Rev B

CUSTOMIZED LENGTHS, COLORS, CABLE TYPES, TERMINATIONS/PLUGS/RECEPTACLES AVAILABLE UPON REQUEST. ADDITIONAL PLUG OPTIONS ARE AVAILABLE AT <https://www.globtek.com/connectors/> STANDARD PLUGS AND CONNECTORS CAN BE SEEN ONLINE AT <https://www.globtek.com/connectors/> ACTUAL CONNECTORS, OVERMOLDS, FERRITES MAY VARY SLIGHTLY FROM THE PICTURE BELOW DIMENSIONS ARE IN MM UNLESS SPECIFIED OTHERWISE

In Addition to GlobTek Inc.'s renewed ISO9001:2008 - Quality Management System Certification, GlobTek Inc. is now certified to:

ISO13485:2003 - Medical Devices Quality Management System Certification
ISO14001:2004 - Environmental Management System Certification

ISO Certificates are available online at <https://www.globtek.com/iso-certificates/>
Prop 65 Statement: <https://en.globtek.com/prop-65-statement.pdf>

The acceptance of this specification and use of the product described in this document indicates the acceptance and binding of the customer to Globtek TERMS AND CONDITIONS (attached to the end of this document), which supersede all other agreements, terms, and conditions (<https://en.globtek.com/terms-and-conditions/>).

The purchaser of this product (Customer) agrees that it is their sole responsibility to determine suitability/fitness of the product described in this specification for their application and to take precautions for protection against any hazards attendant to the handling and use of the product.

Footnote:

GlobTek Inc. will not be liable for the safety and performance of these power supplies if unauthorized access and repair occurs. End user should consult applicable UL, CSA or EN standards for proper installation instruction.

Limitation of Use:

GlobTek products are intended for use with commercial, medical, and/or industrial equipment only. GlobTek product are not authorized for use as mission critical components in life support hazardous environment, nuclear or aircraft applications without prior written approval from the CEO of GlobTek Inc.
Contents of this document are subject to change without prior notice.

Customer Approval of Specification:

Please approve, sign and send back to GlobTek so we can complete order processing.
A delay in receipt of this form will delay delivery schedule.

Company Name: _____	Customer P/N: _____
Quote Number: _____	Date: _____
Authorized Representative Name: _____	Authorized Representative Signature: _____

GlobTek, Inc. www.globtek.com 186 Veterans Drive, Northvale, NJ 07647 Tel. (201) 784-1000 Fax (201) 784-0111	Drawing Title: TYPE O THAILAND 10A PLUG, 2 PRINGS + GROUND, TIS 166-2549 TYPE, 228B to IEC 60320 C13 DETACHEABLE POWER CONNECTOR, GT Cable #376: 1.0 mm ² / 3 Conductors, 7.0±0.1mm OD, VCT-G or H05VV-F, 70 Deg.C, 500V, BLU/BRN/GRN-YW, Approvals: CCC, H05VVF: IEC 60227, 2500±50mm, GlobTek Black	
	Model No. Power Cord	Part No./Ordering No. 6363762M5701(R)
		Rev B

CUSTOMIZED LENGTHS, COLORS, CABLE TYPES, TERMINATIONS/PLUGS/RECEPTACLES AVAILABLE UPON REQUEST. ADDITIONAL PLUG OPTIONS ARE AVAILABLE AT <https://www.globtek.com/connectors/> STANDARD PLUGS AND CONNECTORS CAN BE SEEN ONLINE AT <https://www.globtek.com/connectors/> ACTUAL CONNECTORS, OVERMOLDS, FERRITES MAY VARY SLIGHTLY FROM THE PICTURE BELOW DIMENSIONS ARE IN MM UNLESS SPECIFIED OTHERWISE

REVISION HISTORY

REV	DESCRIPTION	SUB	DATE	APPROVED
B	Add TIS to cable; Change connector approval to VDE; TIS marking on connector is not required; Change cable type to VCTF/H05VV-F with TIS approval.	bsiep	01/10/2023	QA
A	Initial release	QA	12/21/2021	QA

Cordset Information:

CordsetColor:GlobTek Black

Cord Length (mm):2500±50

NOTES:

GlobTek, Inc. www.globtek.com 186 Veterans Drive, Northvale, NJ 07647 Tel. (201) 784-1000 Fax (201) 784-0111	Drawing Title: TYPE O THAILAND 10A PLUG, 2 PRINGS + GROUND, TIS 166-2549 TYPE, 228B to IEC 60320 C13 DETACHABLE POWER CONNECTOR, GT Cable #376: 1.0 mm ² / 3 Conductors, 7.0±0.1mm OD, VCT-G or H05VV-F, 70 Deg.C, 500V, BLU/BRN/GRN-YW, Approvals: CCC, H05VVF: IEC 60227, 2500±50mm, GlobTek Black Model No. Power Cord Part No./Ordering No. 6363762M5701(R)	Rev B
-----------------------------------------------------------------------------------------------------------------------------	----------------------------------------------------------------------------------------------------------------------------------------------------------------------------------------------------------------------------------------------------------------------------------------------------------------------------------------------------------------------------------	-------

CUSTOMIZED LENGTHS, COLORS, CABLE TYPES, TERMINATIONS/PLUGS/RECEPTACLES AVAILABLE UPON REQUEST. ADDITIONAL PLUG OPTIONS ARE AVAILABLE AT <https://www.globtek.com/connectors/> STANDARD PLUGS AND CONNECTORS CAN BE SEEN ONLINE AT <https://www.globtek.com/connectors/> ACTUAL CONNECTORS, OVERMOLDS, FERRITES MAY VARY SLIGHTLY FROM THE PICTURE BELOW DIMENSIONS ARE IN MM UNLESS SPECIFIED OTHERWISE

END A

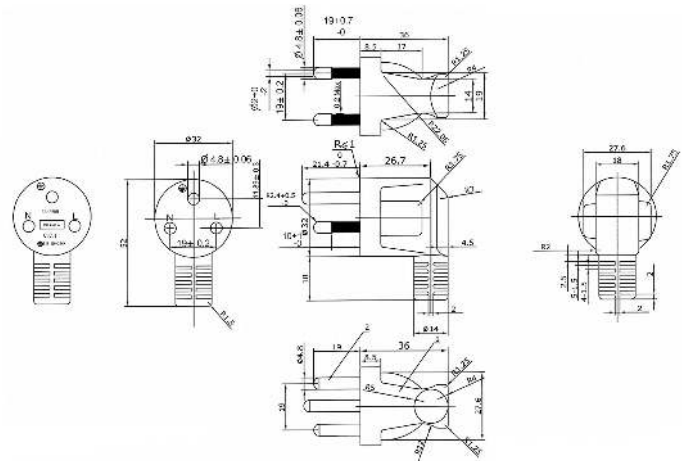

END B

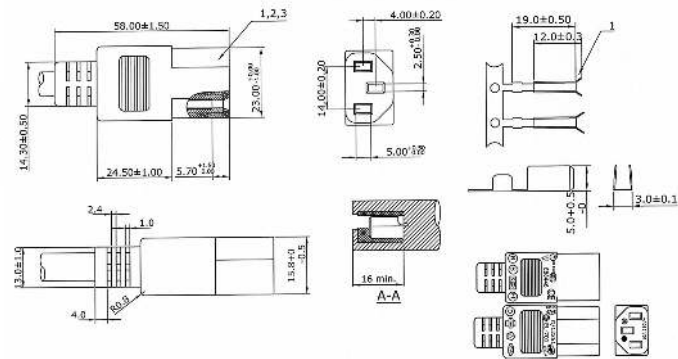

GlobTek, Inc. www.globtek.com 186 Veterans Drive, Northvale, NJ 07647 Tel. (201) 784-1000 Fax (201) 784-0111	Drawing Title: TYPE O THAILAND 10A PLUG, 2 PRINGS + GROUND, TIS 166-2549 TYPE, 228B to IEC 60320 C13 DETACHABLE POWER CONNECTOR, GT Cable #376: 1.0 mm ² / 3 Conductors, 7.0±0.1mm OD, VCT-G or H05VV-F, 70 Deg.C, 500V, BLU/BRN/GRN-YW, Approvals: CCC, H05VV-F: IEC 60227, 2500±50mm, GlobTek Black	
	Model No. Power Cord	Rev B
Part No./Ordering No. 6363762M5701(R)		

CUSTOMIZED LENGTHS, COLORS, CABLE TYPES, TERMINATIONS/PLUGS/RECEPTACLES AVAILABLE UPON REQUEST. ADDITIONAL PLUG OPTIONS ARE AVAILABLE AT <https://www.globtek.com/connectors/> STANDARD PLUGS AND CONNECTORS CAN BE SEEN ONLINE AT <https://www.globtek.com/connectors/> ACTUAL CONNECTORS, OVERMOLDS, FERRITES MAY VARY SLIGHTLY FROM THE PICTURE BELOW DIMENSIONS ARE IN MM UNLESS SPECIFIED OTHERWISE

CABLE IMAGE

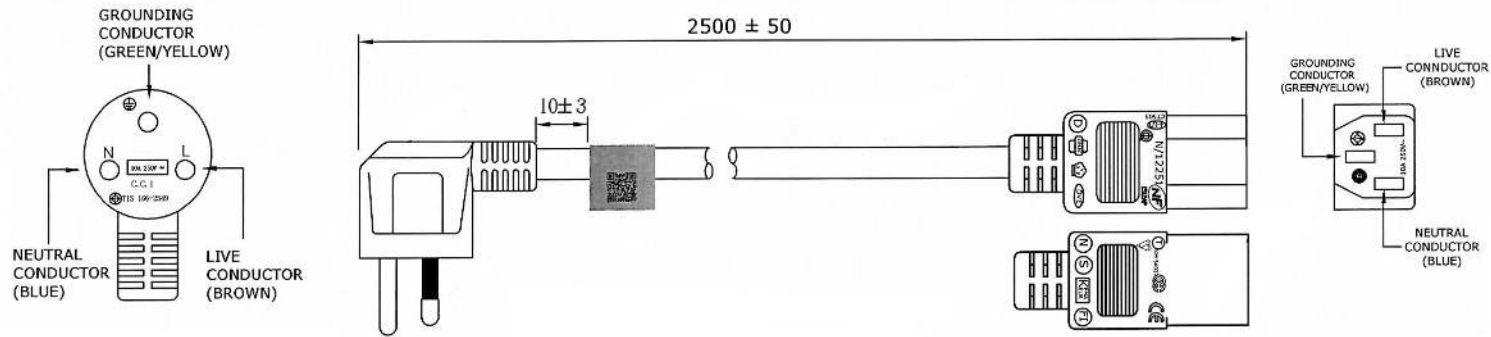



GlobTek, Inc. www.globtek.com 186 Veterans Drive, Northvale, NJ 07647 Tel. (201) 784-1000 Fax (201) 784-0111	Drawing Title: TYPE O THAILAND 10A PLUG, 2 PRINGS + GROUND, TIS 166-2549 TYPE, 228B to IEC 60320 C13 DETACHEABLE POWER CONNECTOR, GT Cable #376: 1.0 mm ² / 3 Conductors, 7.0±0.1mm OD, VCT-G or H05VV-F, 70 Deg.C, 500V, BLU/BRN/GRN-YW, Approvals: CCC, H05VVF: IEC 60227, 2500±50mm, GlobTek Black	
	Model No. Power Cord	Part No./Ordering No. 6363762M5701(R)
		Rev B

CUSTOMIZED LENGTHS, COLORS, CABLE TYPES, TERMINATIONS/PLUGS/RECEPTACLES AVAILABLE UPON REQUEST. ADDITIONAL PLUG OPTIONS ARE AVAILABLE AT <https://www.globtek.com/connectors/> STANDARD PLUGS AND CONNECTORS CAN BE SEEN ONLINE AT <https://www.globtek.com/connectors/> ACTUAL CONNECTORS, OVERMOLDS, FERRITES MAY VARY SLIGHTLY FROM THE PICTURE BELOW DIMENSIONS ARE IN MM UNLESS SPECIFIED OTHERWISE

End A Code:636B Description:TYPE O THAILAND 10A PLUG, 2 PRINGS + GROUND, TIS 166-2549 TYPE, 228B Rating (V):250 Rating (A):10.0 Gender:Male Overmolded:Yes	Cable Code:376 Description:GT Cable #376: 1.0 mm ² / 3 Conductors, 7.0±0.1mm OD, VCT-G or H05VV-F, 70 Deg.C, 500V, BLU/BRN/GRN-YW, Approvals: CCC, H05VVF: IEC 60227 Color:GlobTek Black Wire Gauge(AWG):1.0 mm ² Cond:3 Type:VCT-G or H05VV-F Temperature:70° C Amps:13 Volts:500 OD:7.0±0.1 ConductorsColors:BLU/BRN/GRN-YW	End B Code:701(TIS) Description:IEC 60320 C13 DETACHEABLE POWER CONNECTOR Rating (V):250 Rating (A):10.0 Gender:Female Overmolded:Yes
------------------------------------------------------------------------------------------------------------------------------------------------------------------------------	--------------------------------------------------------------------------------------------------------------------------------------------------------------------------------------------------------------------------------------------------------------------------------------------------------------------------------------------------------------------------------------	---------------------------------------------------------------------------------------------------------------------------------------------------------

Overall cable rating:10A 250VAC

Plug Approvals	Cable Approvals	Connector Approvals
		
THAILAND TIS	THAILAND TIS	Connector has many EU approval markings, including VDE. TIS marking is not required on the connector. THAILAND TIS

AGENCY ONLINE DOCUMENTS	http://en.globtek.com/cordsets/
RoHS/RoHS3 Declaration	https://www.globtek.com/pdf/rohs_cert/01t3a000005KGY4AAO
REACH Declaration	https://www.globtek.com/pdf/iso_certificates/REACH.pdf
Conflict Minerals Declaration	https://www.globtek.com/pdf/conflict-minerals.pdf
Prop 65 Statement	https://en.globtek.com/prop-65-statement.pdf
CE.UKCA.Cord	https://globtek.secure.force.com/spec/ec_decl_product_model_family_incl_cord?id=01t3a000005KGY4

PROPRIETARY INFORMATION

PROPRIETARY OF GLOBTEK, INC. ANY REPRODUCTION, DISCLOSURE OR USE OF THIS DRAWING, IN WHOLE OR IN PART, IS HEREBY PROHIBITED EXCEPT AS SPECIFIED IN WRITING BY GLOBTEK, INC. © GlobTek, Inc. 2021 - 2023

quest /09/30/2023 11:36:50 AM CLONED FROM 6023602M5701(R)

GlobTek, Inc. www.globtek.com 186 Veterans Drive, Northvale, NJ 07647 Tel. (201) 784-1000 Fax (201) 784-0111	Drawing Title: TYPE O THAILAND 10A PLUG, 2 PRINGS + GROUND, TIS 166-2549 TYPE, 228B to IEC 60320 C13 DETACHEABLE POWER CONNECTOR, GT Cable #376: 1.0 mm ² / 3 Conductors, 7.0±0.1mm OD, VCT-G or H05VV-F, 70 Deg.C, 500V, BLU/BRN/GRN-YW, Approvals: CCC, H05VVF: IEC 60227, 2500±50mm, GlobTek Black	
	Model No. Power Cord	Part No./Ordering No. 6363762M5701(R)
		Rev B

CUSTOMIZED LENGTHS, COLORS, CABLE TYPES, TERMINATIONS/PLUGS/RECEPTACLES AVAILABLE UPON REQUEST. ADDITIONAL PLUG OPTIONS ARE AVAILABLE AT <https://www.globtek.com/connectors/> STANDARD PLUGS AND CONNECTORS CAN BE SEEN ONLINE AT <https://www.globtek.com/connectors/> ACTUAL CONNECTORS, OVERMOLDS, FERRITES MAY VARY SLIGHTLY FROM THE PICTURE BELOW DIMENSIONS ARE IN MM UNLESS SPECIFIED OTHERWISE

IPXY rating is based on 3rd party testing and customers should check suitability and test system level IPXY rating before ordering.

GlobTek, Inc. www.globtek.com 186 Veterans Drive, Northvale, NJ 07647 Tel. (201) 784-1000 Fax (201) 784-0111	Drawing Title: TYPE O THAILAND 10A PLUG, 2 PRINGS + GROUND, TIS 166-2549 TYPE, 228B to IEC 60320 C13 DETACHEABLE POWER CONNECTOR, GT Cable #376: 1.0 mm ² / 3 Conductors, 7.0±0.1mm OD, VCT-G or H05VV-F, 70 Deg.C, 500V, BLU/BRN/GRN-YW, Approvals: CCC, H05VV-F: IEC 60227, 2500±50mm, GlobTek Black	
	Model No. Power Cord	Rev B
Part No./Ordering No. 6363762M5701(R)		

CUSTOMIZED LENGTHS, COLORS, CABLE TYPES, TERMINATIONS/PLUGS/RECEPTACLES AVAILABLE UPON REQUEST. ADDITIONAL PLUG OPTIONS ARE AVAILABLE AT <https://www.globtek.com/connectors/> STANDARD PLUGS AND CONNECTORS CAN BE SEEN ONLINE AT <https://www.globtek.com/connectors/> ACTUAL CONNECTORS, OVERMOLDS, FERRITES MAY VARY SLIGHTLY FROM THE PICTURE BELOW DIMENSIONS ARE IN MM UNLESS SPECIFIED OTHERWISE

Hanking:636-701
 Description:250 +/- 20
 Image:

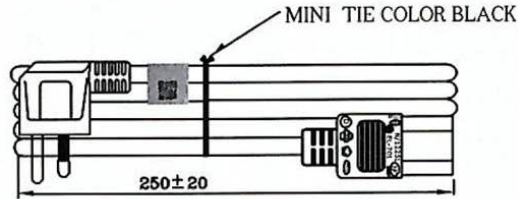

Notes/Modifications/Customizations (notes in this section supersede the values shown in the standard spec):

GlobTek, Inc. www.globtek.com 186 Veterans Drive, Northvale, NJ 07647 Tel. (201) 784-1000 Fax (201) 784-0111	Drawing Title: TYPE O THAILAND 10A PLUG, 2 PRINGS + GROUND, TIS 166-2549 TYPE, 228B to IEC 60320 C13 DETACHEABLE POWER CONNECTOR, GT Cable #376: 1.0 mm ² / 3 Conductors, 7.0±0.1mm OD, VCT-G or H05VV-F, 70 Deg.C, 500V, BLU/BRN/GRN-YW, Approvals: CCC, H05VVF: IEC 60227, 2500±50mm, GlobTek Black	
	Model No. Power Cord	Rev B
Part No./Ordering No. 6363762M5701(R)		

CUSTOMIZED LENGTHS, COLORS, CABLE TYPES, TERMINATIONS/PLUGS/RECEPTACLES AVAILABLE UPON REQUEST. ADDITIONAL PLUG OPTIONS ARE AVAILABLE AT <https://www.globtek.com/connectors/> STANDARD PLUGS AND CONNECTORS CAN BE SEEN ONLINE AT <https://www.globtek.com/connectors/> ACTUAL CONNECTORS, OVERMOLDS, FERRITES MAY VARY SLIGHTLY FROM THE PICTURE BELOW DIMENSIONS ARE IN MM UNLESS SPECIFIED OTHERWISE

Label Drawing:

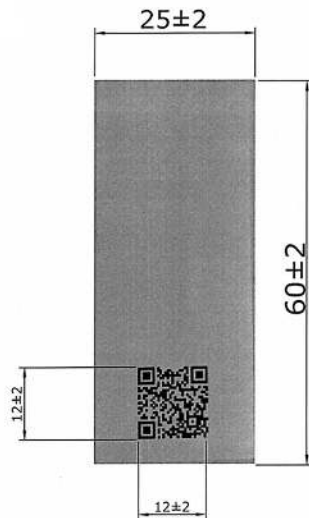

- * QR Code Contents
- Certificate of Registration
- Establishment name
- Details of the Product
- Model (Size, Model ,Trademark)
- License No
- License No. 715818-10/166

MATERIAL

1. PP SYNTHETIC PAPER LABEL