

CARMEN-50-S-C

~24° spot beam. Assembly with holder C compatible with LEDiL HEKLA.

SPECIFICATION:

Dimensions	Ø 50.0 mm
Height	25.5 mm
Fastening	socket
ROHS compliant	yes ⓘ



MATERIALS:

Component	Type	Material	Colour	Finish
CARMEN-50-S	Single lens	PMMA	clear	
CARMEN-50-HLD-C	Holder	PC	black	





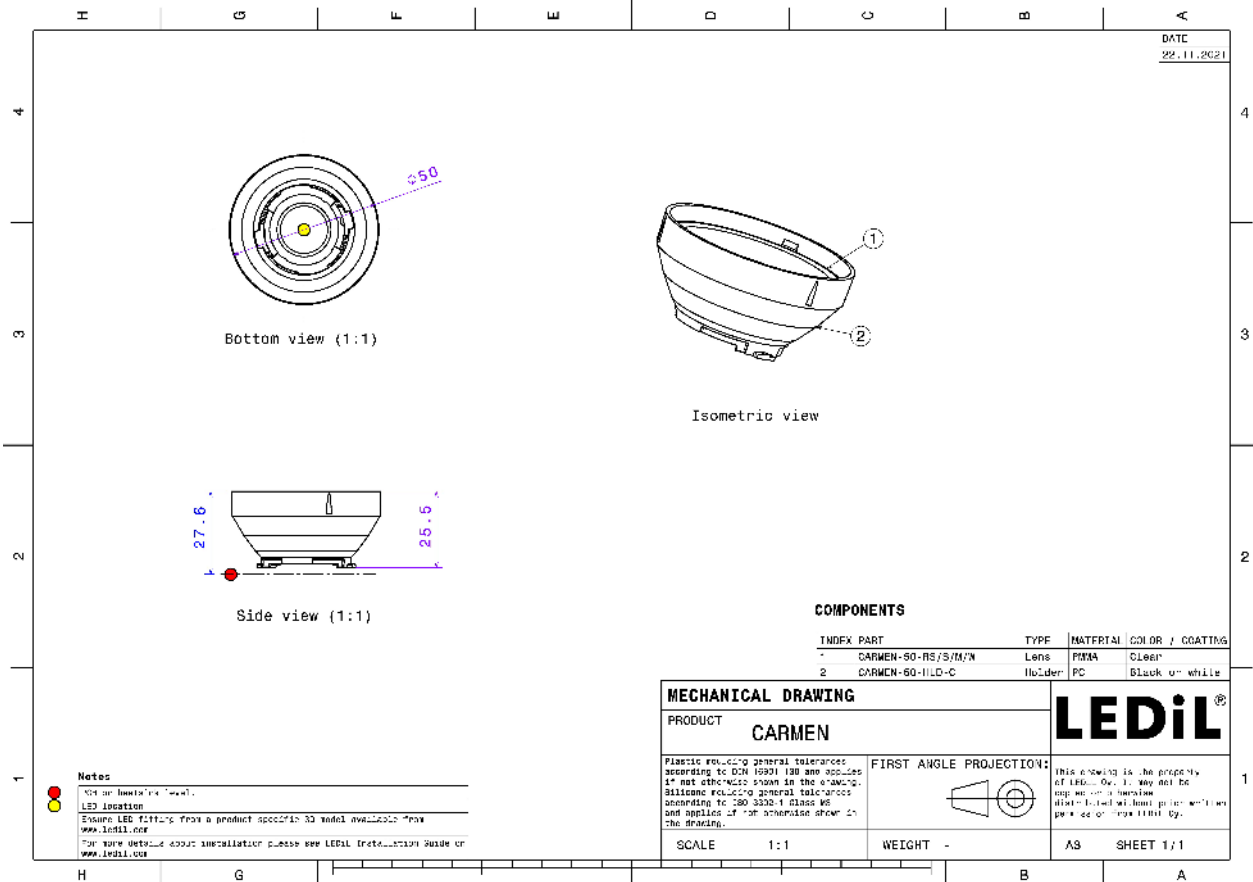

ORDERING INFORMATION:

Component	Type	Qty in box	MOQ	MPQ	Box weight (kg)
CP16107_CARMEN-50-S-C » Box size: 476 x 273 x 292 mm	Single lens	308	112	28	6.9

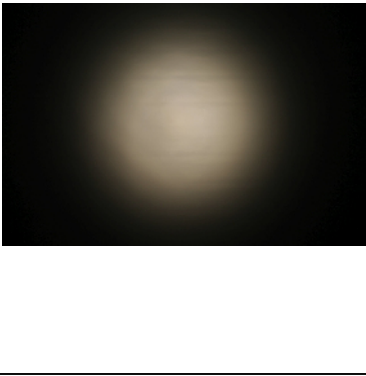
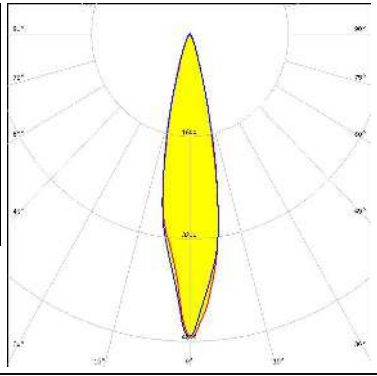

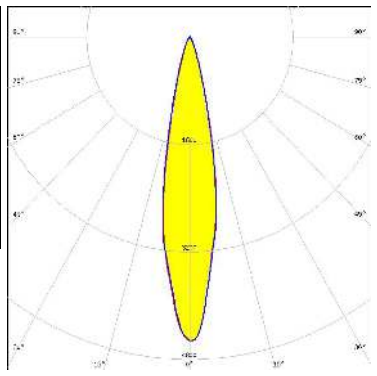

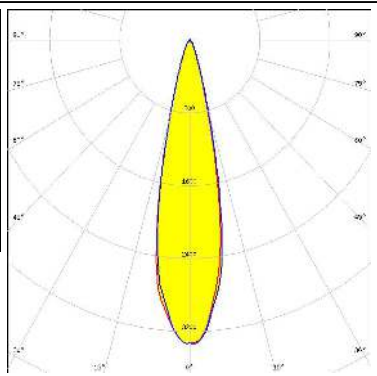

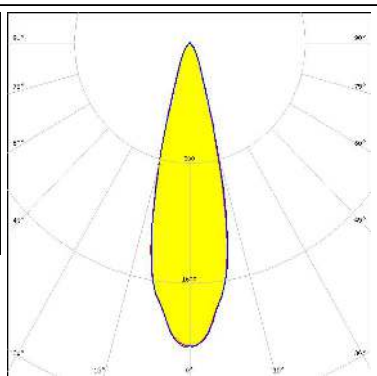

See also our general installation guide: www.ledil.com/installation_guide

OPTICAL RESULTS (MEASURED):

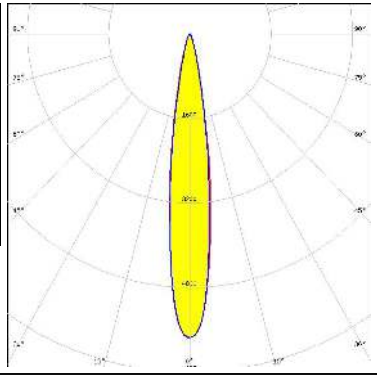
<p></p> <p>LED V4 HD Gen 7</p> <p>FWHM / FWTM 21.0° / 38.0°</p> <p>Efficiency 79 %</p> <p>Peak intensity 4.7 cd/lm</p> <p>LEDs/each optic 1</p> <p>Light colour White</p> <p>Required components: F15253_HEKLA-SOCKET-A</p>		
<p></p> <p>LED V6 HD Gen 7</p> <p>FWHM / FWTM 20.0° / 38.0°</p> <p>Efficiency 73 %</p> <p>Peak intensity 4.5 cd/lm</p> <p>LEDs/each optic 1</p> <p>Light colour White</p> <p>Required components: F15255_HEKLA-SOCKET-C</p>		
<p></p> <p>LED V9 HD Gen7</p> <p>FWHM / FWTM 23.0° / 40.0°</p> <p>Efficiency 65 %</p> <p>Peak intensity 3.3 cd/lm</p> <p>LEDs/each optic 1</p> <p>Light colour White</p> <p>Required components: F15859_HEKLA-SOCKET-I</p>		
<p></p> <p>LED VERO13</p> <p>FWHM / FWTM 27.0° / 46.0°</p> <p>Efficiency 53 %</p> <p>Peak intensity 2 cd/lm</p> <p>LEDs/each optic 1</p> <p>Light colour White</p> <p>Required components: C16142_HEKLA-SOCKET-K</p>		

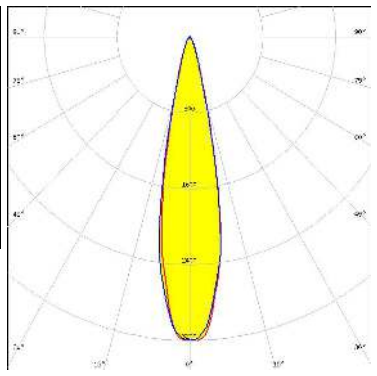
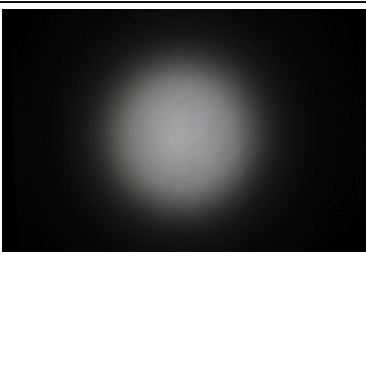
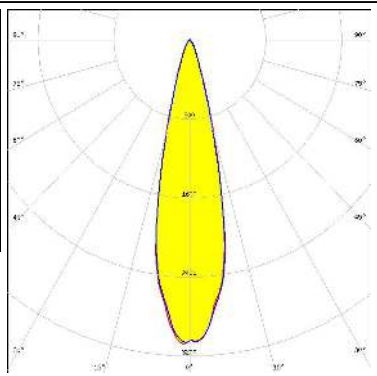
OPTICAL RESULTS (MEASURED):

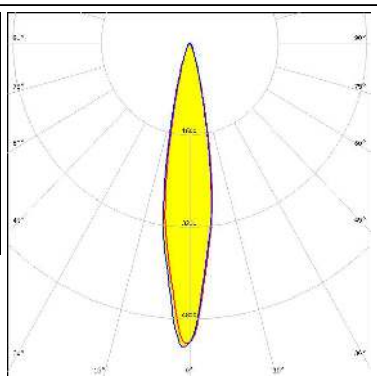
<p></p> <p>LED Vesta TW 6mm DP FWHM / FWTM 15.0° / 31.0° Efficiency 63 % Peak intensity 5.7 cd/m LEDs/each optic 1 Light colour White Required components: C16142_HEKLA-SOCKET-K Bender Wirth: 504 Typ L8</p>		
<p></p> <p>LED Vesta TW 9mm (9W) DP FWHM / FWTM 22.0° / 37.0° Efficiency 55 % Peak intensity 3.2 cd/m LEDs/each optic 1 Light colour White Required components: C16142_HEKLA-SOCKET-K Bender Wirth: 489 Typ L8</p>		
<p>CITIZEN</p> <p>LED CLL02x/CLU02x (LES10) FWHM / FWTM 24.0° / 42.0° Efficiency 66 % Peak intensity 3.1 cd/m LEDs/each optic 1 Light colour White Required components: F15255_HEKLA-SOCKET-C</p>		
<p>CITIZEN</p> <p>LED CLU700/701/702/703 FWHM / FWTM 19.0° / 35.0° Efficiency 73 % Peak intensity 5.3 cd/m LEDs/each optic 1 Light colour White Required components: F15255_HEKLA-SOCKET-C</p>		

OPTICAL RESULTS (MEASURED):

CITIZEN

LED CLU710/711
 FWHM / FWTM 22.0° / 39.0°
 Efficiency 65 %
 Peak intensity 3.5 cd/lm
 LEDs/each optic 1
 Light colour White
 Required components:
 F15859_HEKLA-SOCKET-I

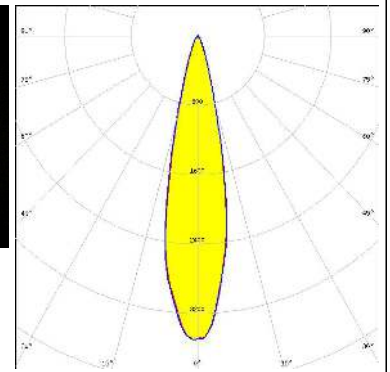

CREE LED

LED CMA1516
 FWHM / FWTM 25.0° / 43.0°
 Efficiency 68 %
 Peak intensity 3 cd/lm
 LEDs/each optic 1
 Light colour White
 Required components:
 F15256_HEKLA-SOCKET-D

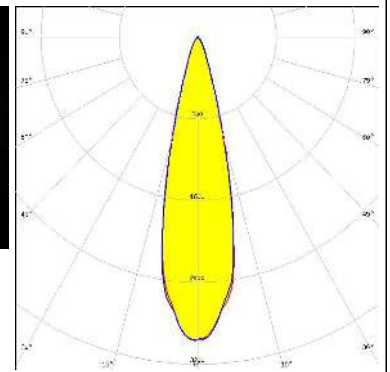
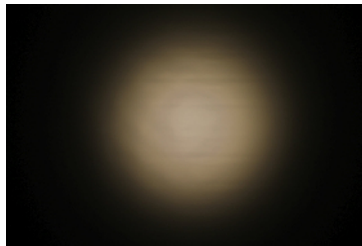

CREE LED

LED CMT14xx
 FWHM / FWTM 25.0° / 43.0°
 Efficiency 44 %
 Peak intensity 1.9 cd/lm
 LEDs/each optic 1
 Light colour White
 Required components:
 F15255_HEKLA-SOCKET-C

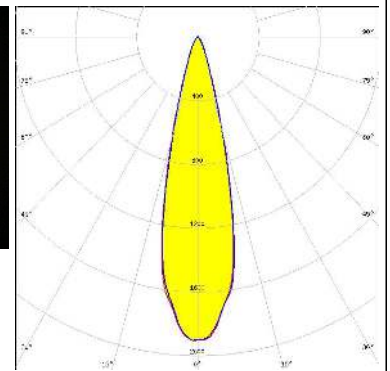
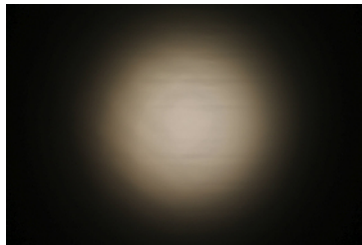





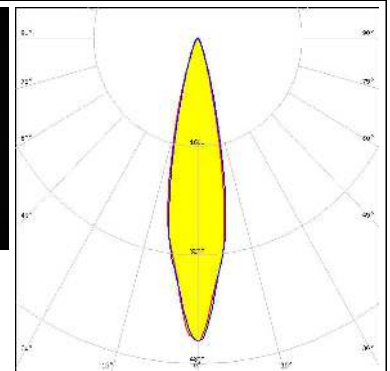

CREE LED

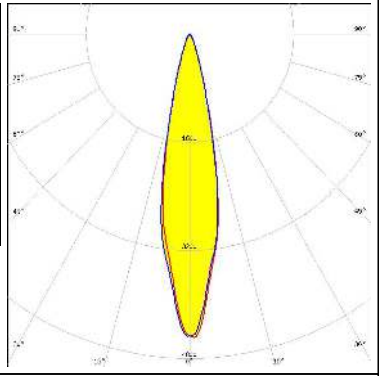

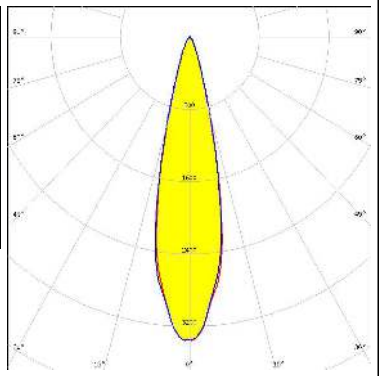

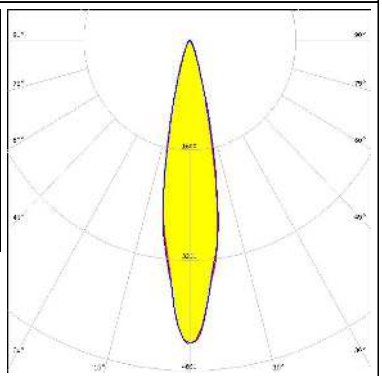
LED CXA/B 13xx
 FWHM / FWTM 22.0° / 39.0°
 Efficiency 77 %
 Peak intensity 4.5 cd/lm
 LEDs/each optic 1
 Light colour White
 Required components:
 F15956_HEKLA-SOCKET-J

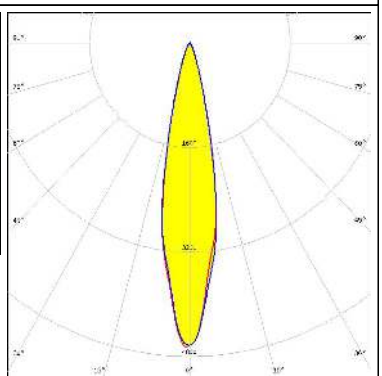



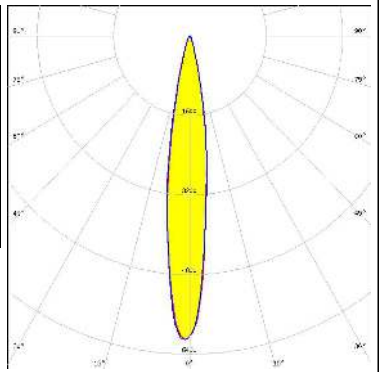

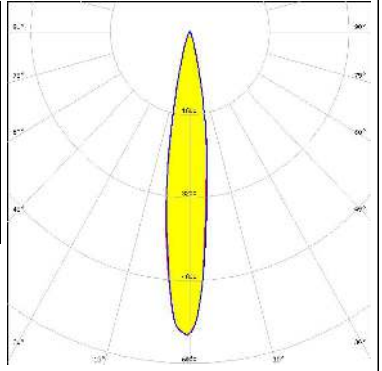
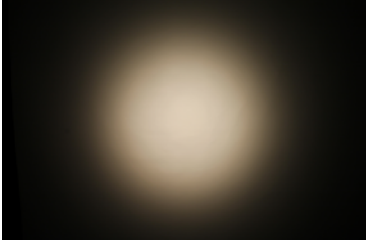
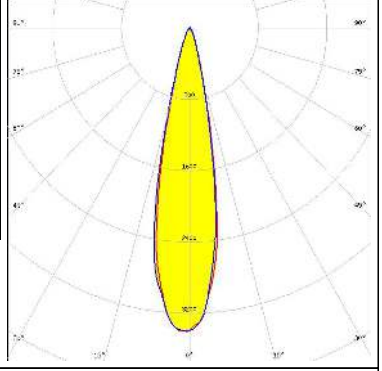
OPTICAL RESULTS (MEASURED):

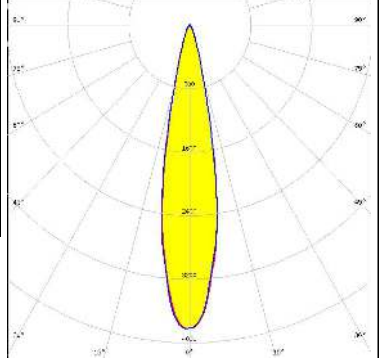
<p>CREE LED</p> <p>LED: CXA/B 13xx FWHM / FWTM: 21.0° / 39.0° Efficiency: 76 % Peak intensity: 4.5 cd/lm LEDs/each optic: 1 Light colour: White Required components: F15956_HEKLA-SOCKET-J</p>		
<p>CREE LED</p> <p>LED: CXA/B 15xx FWHM / FWTM: 24.0° / 41.0° Efficiency: 69 % Peak intensity: 3.4 cd/lm LEDs/each optic: 1 Light colour: White Required components: F15256_HEKLA-SOCKET-D</p>		
<p>LUMILEDS</p> <p>LED: LUXEON CoB 1202HD FWHM / FWTM: 21.0° / 38.0° Efficiency: 73 % Peak intensity: 4.4 cd/lm LEDs/each optic: 1 Light colour: White Required components: F15848_HEKLA-SOCKET-G</p>		
<p>LUMILEDS</p> <p>LED: LUXEON CoB 1202s FWHM / FWTM: 21.0° / 38.0° Efficiency: 75 % Peak intensity: 4.7 cd/lm LEDs/each optic: 1 Light colour: White Required components: F15848_HEKLA-SOCKET-G</p>		



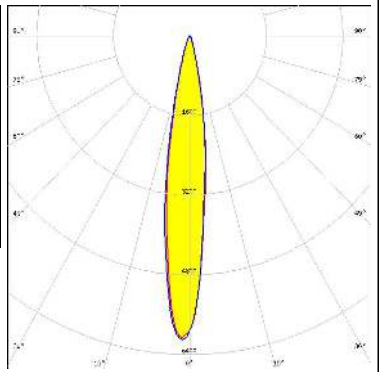
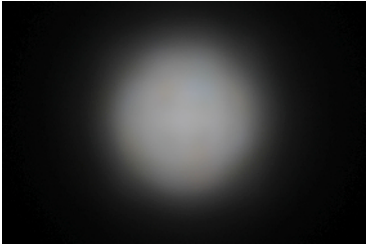
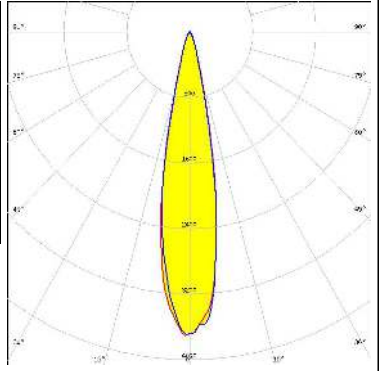

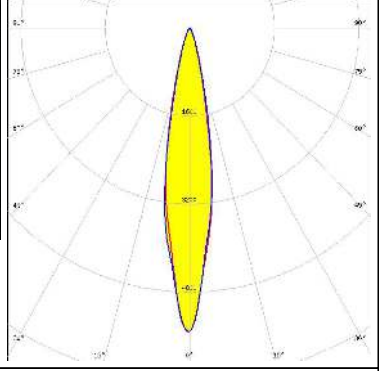
OPTICAL RESULTS (MEASURED):

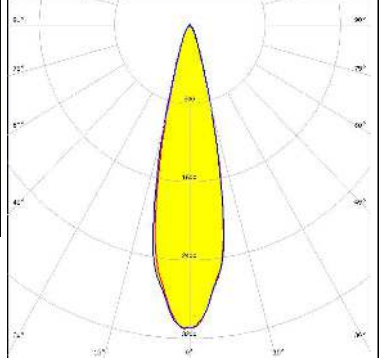
<p>LUMILEDS</p> <p>LED LUXEON CX Plus CoB - HD S01H4</p> <p>FWHM / FWTM 16.0° / 32.0°</p> <p>Efficiency 68 %</p> <p>Peak intensity 6.1 cd/m</p> <p>LEDs/each optic 1</p> <p>Light colour White</p> <p>Required components: Bender Wirth: 634c Hekla</p>		
<p>LUMILEDS</p> <p>LED LUXEON CX Plus CoB - HD S01H6 / HD S02H6</p> <p>FWHM / FWTM 16.0° / 32.0°</p> <p>Efficiency 67 %</p> <p>Peak intensity 5.9 cd/m</p> <p>LEDs/each optic 1</p> <p>Light colour White</p> <p>Required components: Bender Wirth: 634c Hekla</p>		
<p>LUMILEDS</p> <p>LED LUXEON CX Plus CoB - HD S04H9</p> <p>FWHM / FWTM 22.0° / 38.0°</p> <p>Efficiency 61 %</p> <p>Peak intensity 3.4 cd/m</p> <p>LEDs/each optic 1</p> <p>Light colour White</p> <p>Required components: Bender Wirth: 634c Hekla</p>		
<p>LUMILEDS</p> <p>LED LUXEON CX Plus CoB M02 / M03 (Gen2)</p> <p>FWHM / FWTM 20.0° / 36.0°</p> <p>Efficiency 61 %</p> <p>Peak intensity 3.8 cd/m</p> <p>LEDs/each optic 1</p> <p>Light colour White</p> <p>Required components: Bender Wirth: 641a Hekla</p>		

OPTICAL RESULTS (MEASURED):

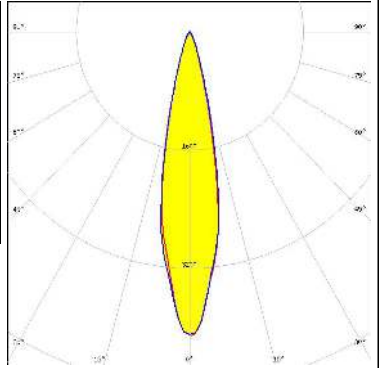
<p>LUMILEDS</p> <p>LED LUXEON CX Plus CoB S01 (Gen2)</p> <p>FWHM / FWTM 15.0° / 31.0°</p> <p>Efficiency 68 %</p> <p>Peak intensity 6.2 cd/lm</p> <p>LEDs/each optic 1</p> <p>Light colour White</p> <p>Required components: Bender Wirth: 634c Hekla</p>		
<p>LUMINUS</p> <p>LED CDM-9 (Dim-To-Warm)</p> <p>FWHM / FWTM 21.0° / 35.0°</p> <p>Efficiency 57 %</p> <p>Peak intensity 3.7 cd/lm</p> <p>LEDs/each optic 1</p> <p>Light colour White</p> <p>Required components: C16142_HEKLA-SOCKET-K Bender Wirth: 490 Typ L8</p>		
<p>LUMINUS</p> <p>LED CXM-4</p> <p>FWHM / FWTM 18.0° / 35.0°</p> <p>Efficiency 76 %</p> <p>Peak intensity 5.5 cd/lm</p> <p>LEDs/each optic 1</p> <p>Light colour White</p> <p>Required components: F15255_HEKLA-SOCKET-C</p>		
<p>LUMINUS</p> <p>LED CxM-9 (13.5x13.5)</p> <p>FWHM / FWTM 24.0° / 42.0°</p> <p>Efficiency 67 %</p> <p>Peak intensity 3.1 cd/lm</p> <p>LEDs/each optic 1</p> <p>Light colour White</p> <p>Required components: F15255_HEKLA-SOCKET-C</p>		

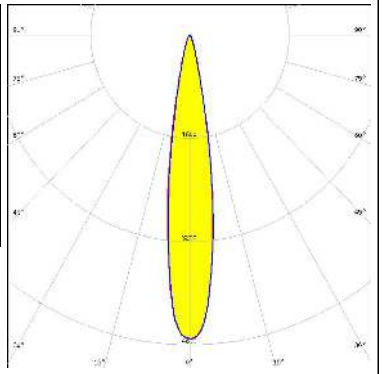
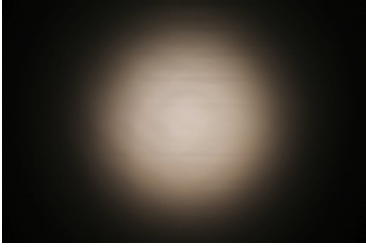
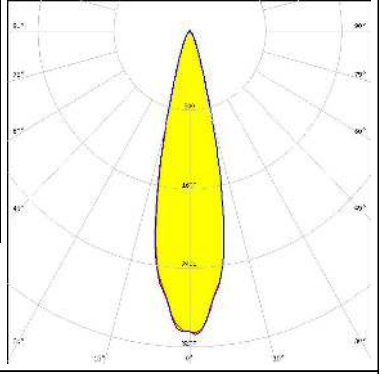
OPTICAL RESULTS (MEASURED):

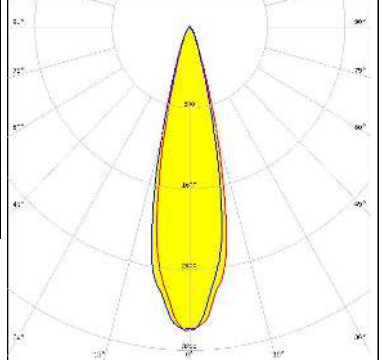
<p>NICHIA</p> <p>LED COB S-Type (LES 7)</p> <p>FWHM / FWTM 22.0° / 39.0°</p> <p>Efficiency 73 %</p> <p>Peak intensity 4.1 cd/lm</p> <p>LEDs/each optic 1</p> <p>Light colour White</p> <p>Required components: F15848_HEKLA-SOCKET-G</p>		
<p>NICHIA</p> <p>LED NJCWL024Z-V1MT: COB L-Type Tunable White</p> <p>FWHM / FWTM 17.0° / 31.0°</p> <p>Efficiency 56 %</p> <p>Peak intensity 4.7 cd/lm</p> <p>LEDs/each optic 1</p> <p>Light colour White</p> <p>Required components: C16142_HEKLA-SOCKET-K Bender Wirth: 497 Typ L8</p>		
<p>PHILIPS</p> <p>LED Fortimo SLM L09 CoB</p> <p>FWHM / FWTM 24.0° / 41.0°</p> <p>Efficiency 65 %</p> <p>Peak intensity 3.1 cd/lm</p> <p>LEDs/each optic 1</p> <p>Light colour White</p> <p>Required components: F15858_HEKLA-SOCKET-H</p>		
<p>SAMSUNG</p> <p>LED LC003D / LC006D / LC009D / LC013D</p> <p>FWHM / FWTM 25.0° / 43.0°</p> <p>Efficiency 67 %</p> <p>Peak intensity 3 cd/lm</p> <p>LEDs/each optic 1</p> <p>Light colour White</p> <p>Required components: F15255_HEKLA-SOCKET-C</p>		

OPTICAL RESULTS (MEASURED):

SAMSUNG

LED LC010C G2
 FWHM / FWTM 19.0° / 35.0°
 Efficiency 74 %
 Peak intensity 5.3 cd/m
 LEDs/each optic 1
 Light colour White
 Required components:
 F15255_HEKLA-SOCKET-C

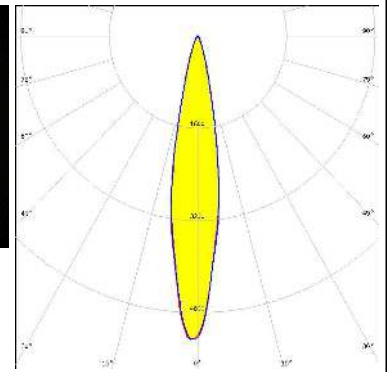
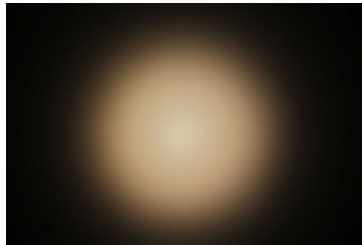

SAMSUNG

LED LC020C G2
 FWHM / FWTM 23.0° / 40.0°
 Efficiency 65 %
 Peak intensity 3.3 cd/m
 LEDs/each optic 1
 Light colour White
 Required components:
 F15859_HEKLA-SOCKET-I

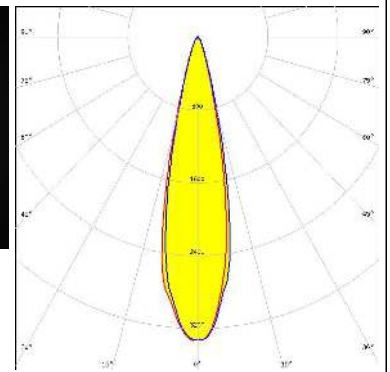
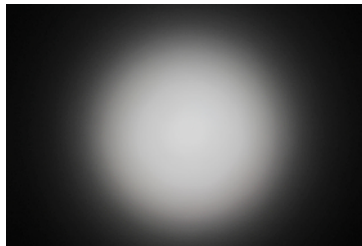

TRIDONIC

LED SLE G7 LES09
 FWHM / FWTM 23.0° / 41.0°
 Efficiency 69 %
 Peak intensity 3.5 cd/m
 LEDs/each optic 1
 Light colour White
 Required components:
 F15255_HEKLA-SOCKET-C

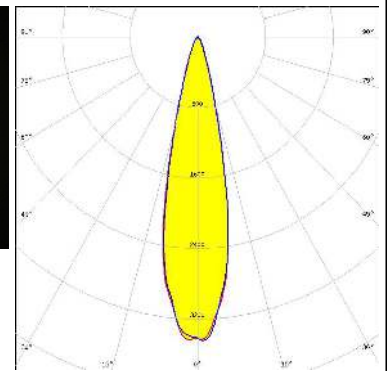
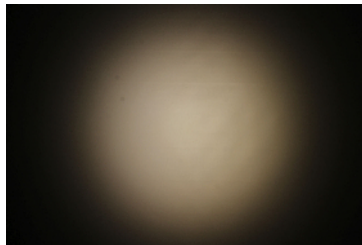

TRIDONIC

LED SLE G7 LES13
 FWHM / FWTM 31.0° / 51.0°
 Efficiency 58 %
 Peak intensity 1.8 cd/m
 LEDs/each optic 1
 Light colour White
 Required components:
 F15859_HEKLA-SOCKET-I

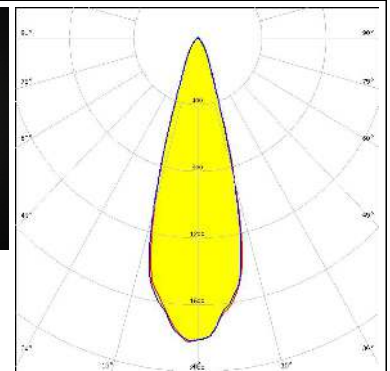
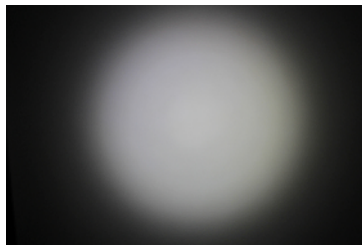

OPTICAL RESULTS (MEASURED):

XICATO

LED XOB 6 mm
FWHM / FWTM 19.0° / 36.0°
Efficiency 73 %
Peak intensity 4.9 cd/lm
LEDs/each optic 1
Light colour White
Required components:
F15255_HEKLA-SOCKET-C

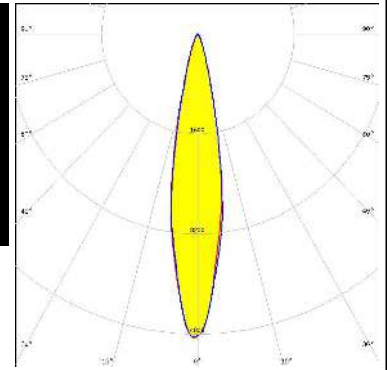
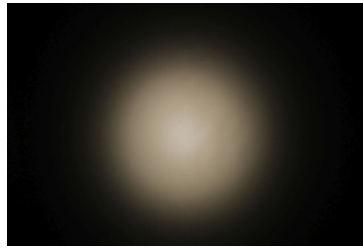





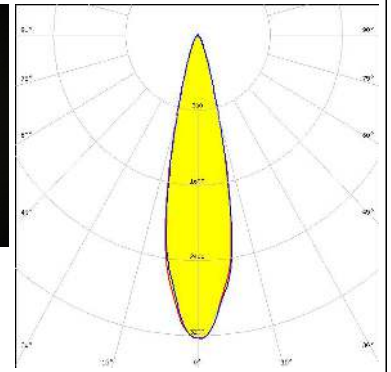

XICATO

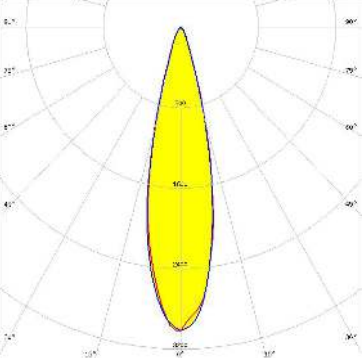
LED XOB 9.8 mm
FWHM / FWTM 24.0° / 42.0°
Efficiency 67 %
Peak intensity 3.2 cd/lm
LEDs/each optic 1
Light colour White
Required components:
F15255_HEKLA-SOCKET-C

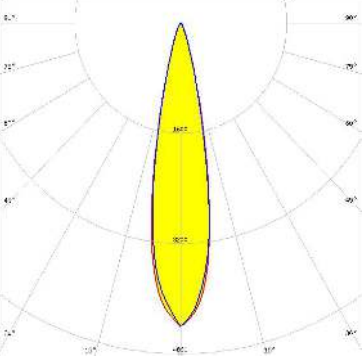

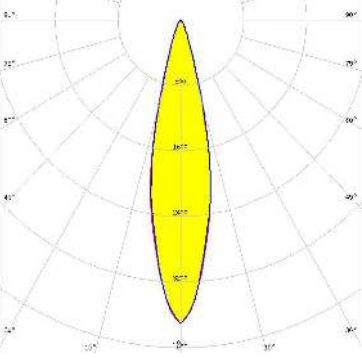
OPTICAL RESULTS (SIMULATED):

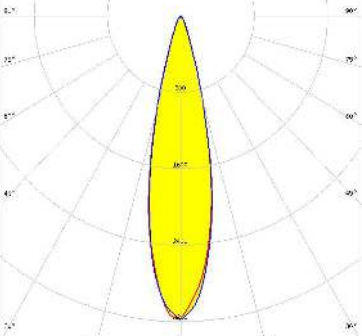
<p></p> <p>LED V10 Gen7 FWHM / FWTM 24.0° / 42.0° Efficiency 65 % Peak intensity 3.1 cd/lm LEDs/each optic 1 Light colour White Required components: F15255_HEKLA-SOCKET-C</p>	
<p></p> <p>LED V6 Gen6 FWHM / FWTM 21.0° / 37.0° Efficiency 71 % Peak intensity 4.4 cd/lm LEDs/each optic 1 Light colour White Required components: F15253_HEKLA-SOCKET-A</p>	
<p></p> <p>LED V8 Gen7 FWHM / FWTM 24.0° / 40.0° Efficiency 71 % Peak intensity 3.7 cd/lm LEDs/each optic 1 Light colour White Required components: F15253_HEKLA-SOCKET-A</p>	
<p></p> <p>LED VERO10 FWHM / FWTM 24.0° / 41.0° Efficiency 64 % Peak intensity 3.2 cd/lm LEDs/each optic 1 Light colour White Required components: F15616_HEKLA-SOCKET-F</p>	

OPTICAL RESULTS (SIMULATED):

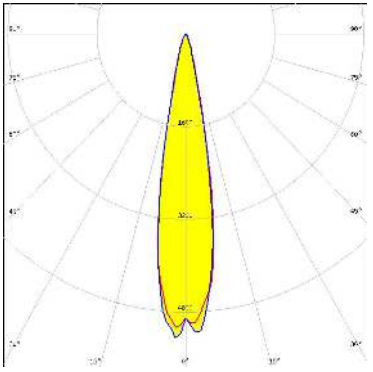
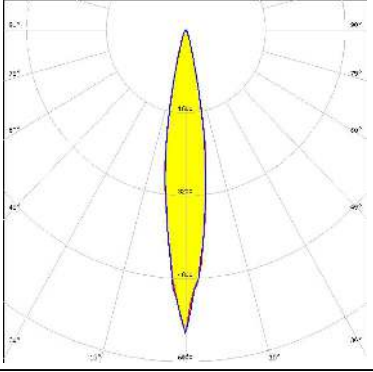
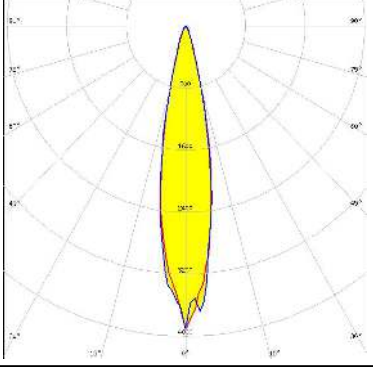
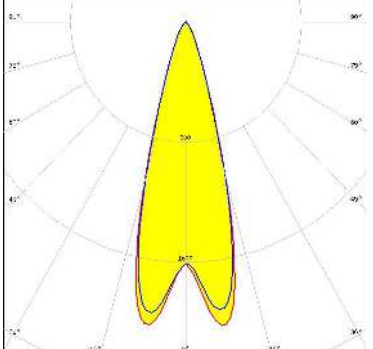
<p>CREE LED</p> <p>LED: CHA0304 FWHM / FWTM: 20.0° / 33.0° Efficiency: 72 % Peak intensity: 5.4 cd/lm LEDs/each optic: 1 Light colour: White Required components: F17435_HEKLA-G2-C</p>	
<p>CREE LED</p> <p>LED: CHA0612 FWHM / FWTM: 16.0° / 31.0° Efficiency: 66 % Peak intensity: 5.9 cd/lm LEDs/each optic: 1 Light colour: White Required components: F17435_HEKLA-G2-C</p>	
<p>CREE LED</p> <p>LED: CHA0825 FWHM / FWTM: 20.0° / 36.0° Efficiency: 60 % Peak intensity: 3.9 cd/lm LEDs/each optic: 1 Light colour: White Required components: F17438_HEKLA-G2-I</p>	
<p>NICHIA</p> <p>LED: COB S-Type (LES 6) FWHM / FWTM: 30.0° / 50.0° Efficiency: 62 % Peak intensity: 2.1 cd/lm LEDs/each optic: 1 Light colour: White Required components: F15848_HEKLA-SOCKET-G</p>	

OPTICAL RESULTS (SIMULATED):

SAMSUNG

LED LH231B
FWHM / FWTM 23.0° / 42.0°
Efficiency 63 %
Peak intensity 3 cd/lm
LEDs/each optic 7
Light colour White
Required components:
F15255_HEKLA-SOCKET-C

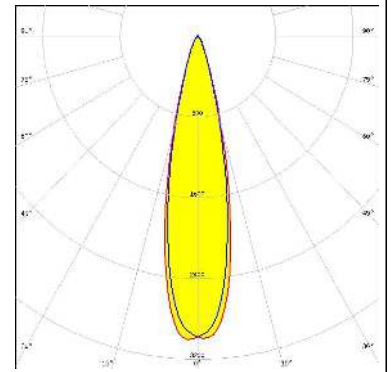

XICATO

LED XTM - 9mm LES
FWHM / FWTM 25.0° / 43.0°
Efficiency 67 %
Peak intensity 3 cd/lm
LEDs/each optic 1
Light colour White
Required components:
C15743_XTM-ADAPTER-50-B

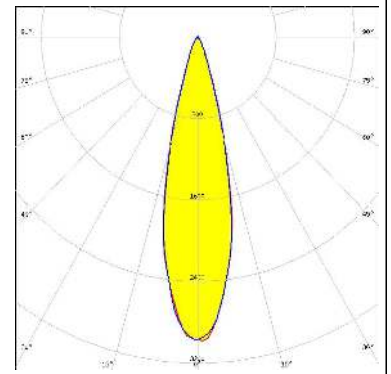

GENERAL INFORMATION:

NOTE: The typical beam angle will be changed by different color, chip size and chip position tolerance. The typical total beam angle is the full angle measured where the luminous intensity is half of the peak value.

Due to use of high power COB's with this product, special attention to proper thermal design is highly recommended. LEDiL has no liability for direct, indirect or consecutive damages arising from the LEDiL products being used outside of the recommended temperature range.

MATERIALS:

As part of our continuous research and improvement processes, and to ensure the best possible quality and availability of our products, LEDiL reserves the right to change material grades without notice.

PRODUCT DATA USER AGREEMENT AND DISCLAIMER:

The measured data in the provided downloadable LEDiL Product Datasheets and Mechanical 2D-Drawings is rounded and provided as reference for planning. LEDiL Oy's optical specifications have been verified by conducting performance testing of the products in accordance with the company's quality system. The reported data are averaged results of multiple measurements with typical variation. LEDiL Oy reserves the right to without prior notification make changes and improvements to its products.

LEDiL Oy assumes neither warranty, nor guarantee nor any other liability of any kind for the contents and correctness of the provided data. The provided data has been generated with highest diligence but the provided data may in reality not represent the complete possible variation range of all intrinsic parameters. Therefore, in certain cases a deviation from the provided data could occur.

LEDiL Oy reserves the right to undertake technical changes of its products without further notification which could lead to changes in the provided data. LEDiL Oy assumes no liability of any kind for the possible deviation from any provided data or any other damage resulting from the usage of the provided data.

The user agrees to this disclaimer and user agreement with the download or usage of the provided files.

LEDiL Oy

Joensuunkatu 13
FI-24240 SALO
Finland

LEDiL Inc.

228 West Page Street
Suite D
Sycamore IL 60178
USA

Ledil Optics Technology (Shenzhen) Co., Ltd.

405 , Block B
Casic Motor Building
Shenzhen 518057
P.R.CHINA

Local sales and technical support

[www.ledil.com/
where_to_buy](http://www.ledil.com/where_to_buy)

Shipping locations

Salo, Finland
Hong Kong, China

Distribution Partners

[www.ledil.com/
where_to_buy](http://www.ledil.com/where_to_buy)