



CAT3604

4-Channel Regulated Charge Pump White LED Driver

FEATURES

- Drives individually up to 4 LEDs
- Output current up to 30mA per LED
- Digital control On/Off of each LED
- Compatible with supply voltage of 3V to 5.5V
- Power efficiency up to 93%
- 2 modes of operation 1x and 1.5x
- Automatic short circuit detect/disable
- High-frequency Operation at 1MHz
- Low value ceramic capacitors
- "604" compatible pinout
- Soft start and current limiting
- Thin QFN 16-lead package, 4x4mm, 0.8mm max height

APPLICATIONS

- Color LCD and keypad Backlighting
- Cellular Phones
- Handheld Devices
- Digital Cameras
- PDAs
- Portable MP3 players

DESCRIPTION

The CAT3604 is a charge pump operating in either 1x (LDO) mode or 1.5x fractional mode regulating current through each of the 4 LED pins. Operation at a fixed high frequency of 1MHz typical allows the use of very small value ceramic capacitors.

The CAT3604 drives white light-emitting diodes (LEDs) connected in parallel and provides tightly matched regulated current to achieve uniformity of brightness in LCD backlighting applications. An external resistor R_{SET} controls the output current level. LED currents of up to 30mA are supported over a range of input supply voltages from 3V to

5.5V, making the device ideal for battery-powered applications.

LED dimming can be accomplished by several methods including using a DC voltage to set the R_{SET} pin current, applying a PWM signal on the Control signals, or adding a switched resistor in parallel with R_{SET} . The Enable input pin allows the device to be placed in power-down mode with "zero" quiescent current.

The CAT3604 features short circuit and overcurrent limiting protection. The device is available in a 16-lead thin QFN package with a max height of 0.8mm.

TYPICAL APPLICATION

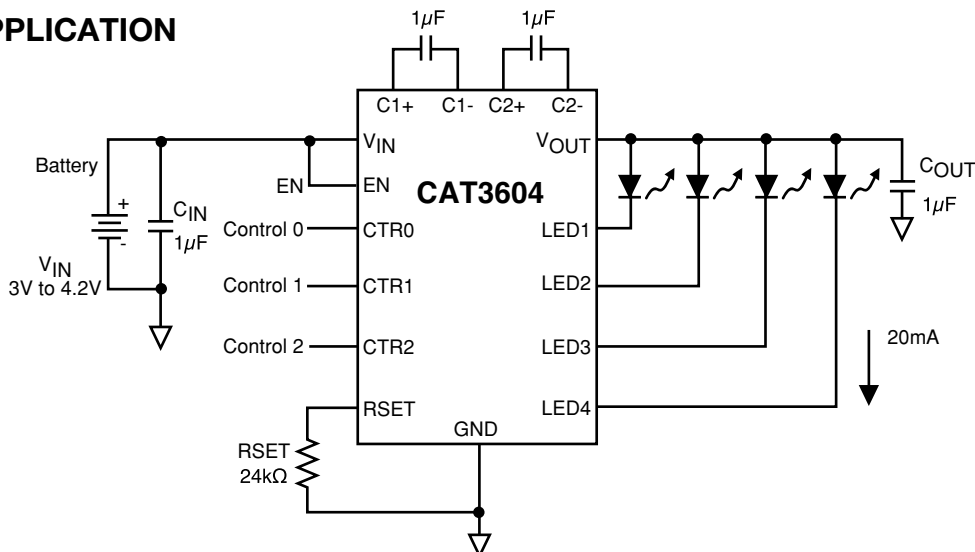

ORDERING INFORMATION

Part Number	Package	Quantity per Reel	Package Marking
CAT3604HS4	Thin QFN-16 4x4mm	2000	C364
CAT3604HV4	Thin QFN-16 4x4mm Lead Free	2000	G364

PIN CONFIGURATION

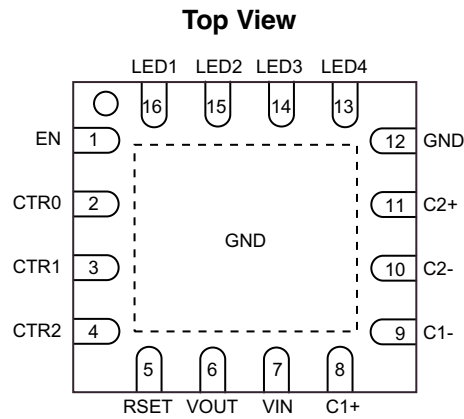

16-lead Thin QFN (4mm x 4mm)

Note: The package exposed pad is electrically connected inside the package to GND and to pin 12.

PIN DESCRIPTIONS

Pin Number	Name	Function
1	EN	Enable input, active HIGH
2	CTR0	Digital control input 0
3	CTR1	Digital control input 1
4	CTR2	Digital control input 2
5	RSET	The LED output current is set by the current sourced out of the RSET pin
6	VOUT	Charge pump output connected to the LED anodes
7	VIN	Supply voltage
8	C1+	Bucket capacitor 1 terminal
9	C1-	Bucket capacitor 1 terminal
10	C2-	Bucket capacitor 2 terminal
11	C2+	Bucket capacitor 2 terminal
12	GND	Ground reference
13	LED4	LED 4 cathode terminal
14	LED3	LED 3 cathode terminal
15	LED2	LED 2 cathode terminal
16	LED1	LED 1 cathode terminal
Pad	GND Pad	Ground reference

ABSOLUTE MAXIMUM RATINGS

Parameter	Rating	Unit
VIN, VOUT, LEDx voltage	-0.3 to 7.0	V
EN, CTRx voltage	-0.3 to VIN	V
RSET voltage	-0.3 to VIN	V
RSET current	±1	mA
Ambient Temperature Range	-40 to +85	°C
Storage Temperature Range	-65 to +160	°C
Lead Temperature	300	°C
ESD Ratings		
Human Body Model (HBM)	2000	V
Machine Model (MM) (note 1)	200	V

Note 1: Machine model is with 200pF capacitor discharged directly into each pin.

RECOMMENDED OPERATING CONDITIONS

Parameter	Rating	Unit
VIN	3.0 to 5.5	V
Ambient Temperature Range	-40 to +85	°C
Input/Output/Bucket Capacitors	1 ±20% typical	µF
I _{LED} per LED pin	0 to 30	mA

ELECTRICAL OPERATING CHARACTERISTICS

Limits over recommended operating conditions unless specified otherwise. Typical values at T_A = 25°C, VIN = 3.5V, I_{RSET} = 5µA

Symbol	Parameter	Conditions	Min	Typ	Max	Unit
I _Q	Quiescent Current	V _{EN} = 0V Shutdown Mode 1x Mode, No Load 1.5x Mode, No Load		0.05 0.3 2.6	1 1 5	µA mA mA
V _{RSET}	RSET Regulated Voltage		1.17	1.2	1.23	V
I _{LED}	Programmed LED Current	I _{RSET} = 5µA I _{RSET} = 37µA I _{RSET} = 78µA		2.4 15.0 30.0		mA mA mA
I _{LED-ACC}	LED Current Accuracy	0.5mA < I _{LED} < 3mA 3mA < I _{LED} < 30mA		±15 ±5		% %
I _{LED-DEV}	LED Channel Matching	(I _{LED} - I _{LEDAVG}) / I _{LEDAVG}		±3		%
R _{OUT}	Output Resistance (Open Loop)	1x Mode 1.5x Mode, I _{OUT} = 100mA		1.4 6.5	2.5 10	Ω Ω
f _{OSC}	Charge Pump Frequency		0.8	1.0	1.3	MHz
T _{DROPOUT}	1x to 1.5x Mode Transition Dropout Delay		0.4	0.6	0.9	ms
I _{EN-CTR}	Input Leakage Current	On Inputs EN, CTR0, 1 & 2		0.001	1	µA
V _{EN-CTR}	High Detect Threshold Low Detect Threshold	On Inputs EN, CTR0, 1 & 2	0.4	0.8 0.7	1.3	V V
I _{SC}	Input Current Limit	VOUT = GND	30	45	60	mA
I _{LIM}	Maximum Input Current	VOUT > 1V	200	400	600	mA

LED CURRENT SETTING

The LED current is set by the external resistor R_{SET} connected between the RSET pin and ground. Table 1 lists various LED currents and the associated R_{SET} resistor value for standard 1% precision surface mount resistors.

LED Current (mA)	R_{SET} (k Ω)
1	649
2	287
5	102
10	49.9
15	32.4
20	23.7
30	15.4

Table 1. RSET Resistor Selection

The digital control lines CTR0, CTR1 and CTR2 allow to turn On or Off a combination of LEDs as shown in Table 2.

Control Lines			LED Outputs			
CTR2	CTR1	CTR0	LED4	LED3	LED2	LED1
0	0	0	-	-	-	ON
0	0	1	-	-	ON	-
0	1	0	-	ON	-	-
0	1	1	ON	-	-	-
1	0	0	-	-	ON	ON
1	0	1	-	ON	ON	ON
1	1	0	ON	ON	ON	ON
1	1	1	-	-	-	-

Table 2: LED Selection

Notes: 1 = logic high (or VIN)
 0 = logic low (or GND)
 - = LED output OFF

SHORT CIRCUIT DETECT/DISABLE

The unused LED channels can also be turned off by connecting the respective LED pins to VOUT. In which case, the corresponding LED driver is disabled and the typical LED sink current is only about 20 μ A. When the following equation is true on any channel, the driver turns off the LED channel:

$$V_{OUT} - V_{LED} \leq 1V \text{ (LED channel OFF)}$$

Note: The CAT3604 is designed to drive LEDs with forward voltage greater than 1V and is not compatible with resistive loads.

TYPICAL CHARACTERISTICS

$V_{IN} = 3.6V$, $EN = V_{IN}$, $C_{IN} = C_{OUT} = 1\mu F$, $R_{SET} = 24k\Omega$, $T_{AMB} = 25^\circ C$, unless otherwise specified.

Efficiency vs. Input Voltage (4 LEDs)

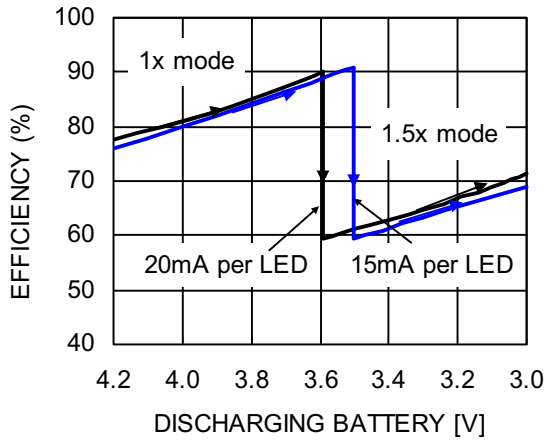

Efficiency vs. Total LED Current (4 LEDs)

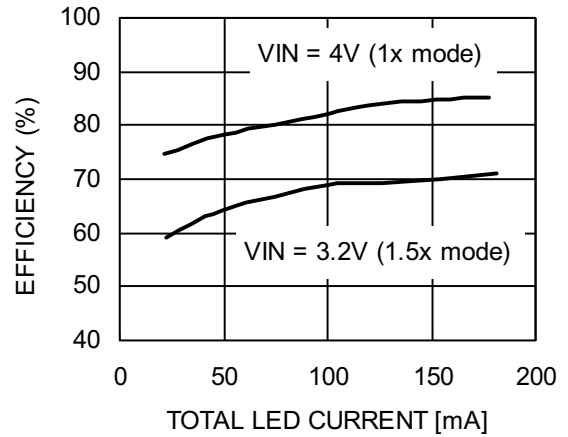

LED Current vs. Input Voltage

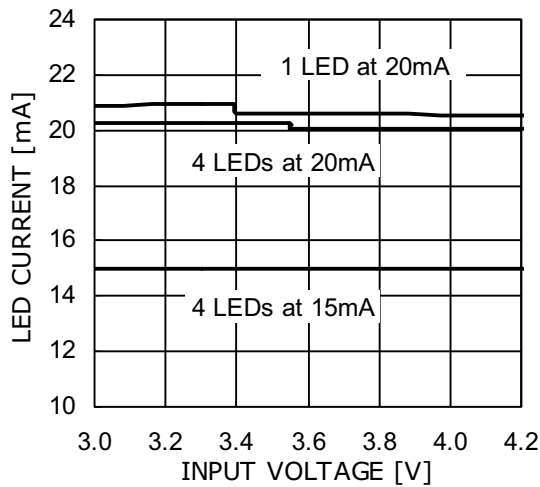

LED Current vs. Temperature

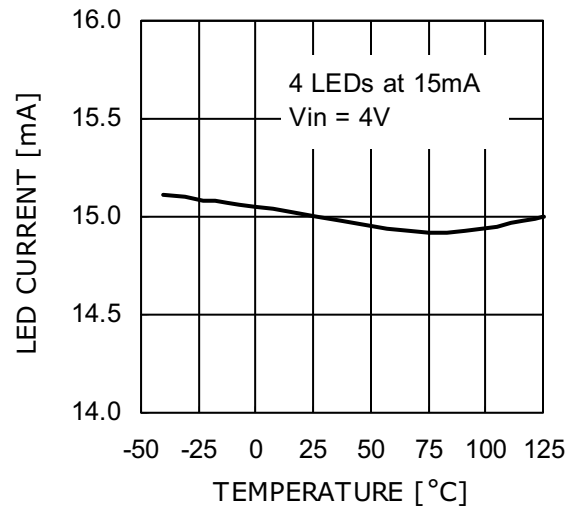

Ground Current vs. Input Voltage (1x mode)

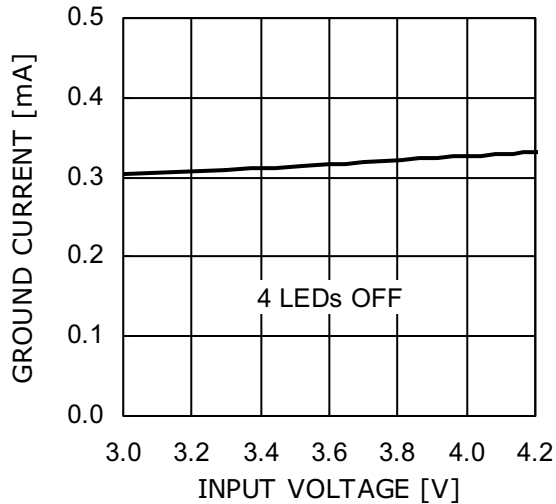

Ground Current vs. Temperature (1x mode)

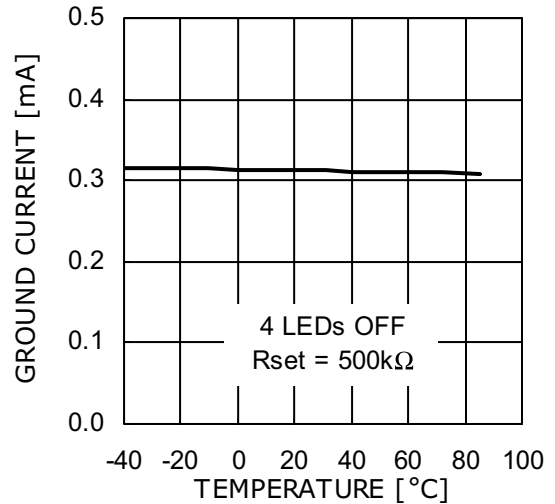

TYPICAL CHARACTERISTICS

$V_{IN} = 3.6V$, $EN = V_{IN}$, $C_{IN} = C_{OUT} = 1\mu F$, $R_{SET} = 24k\Omega$, $T_{AMB} = 25^\circ C$, unless otherwise specified.

Ground Current vs. Input Voltage (1.5x mode)

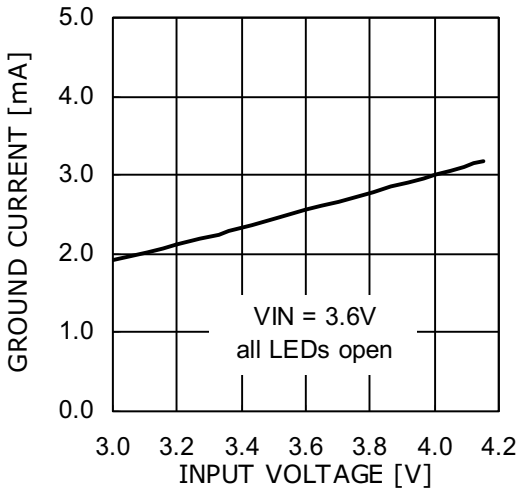

Supply Current vs. Input Voltage

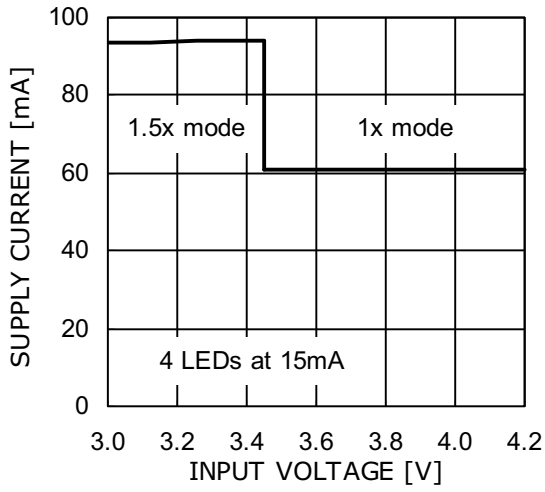

Oscillator Frequency vs. Input Voltage

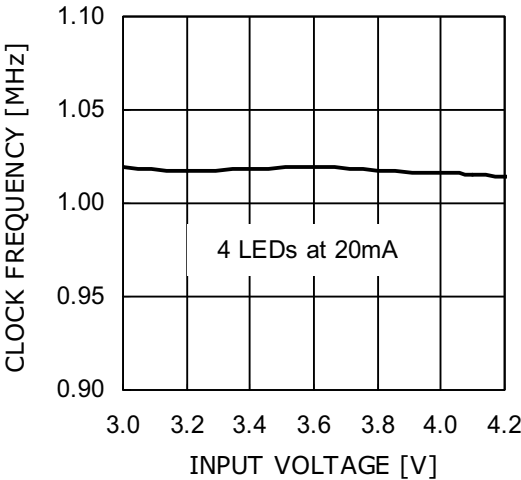

Oscillator Frequency vs. Temperature

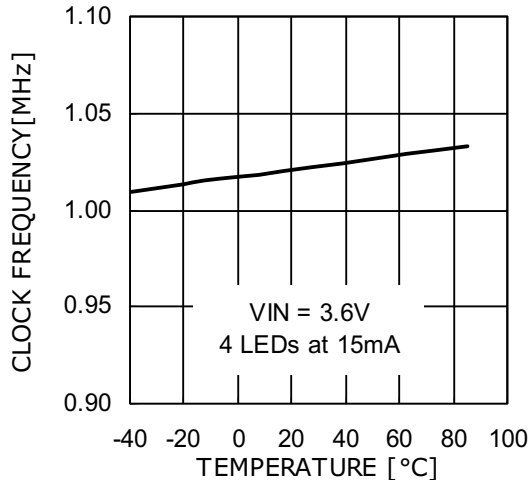

Output Resistance vs. Input Voltage (1x mode)

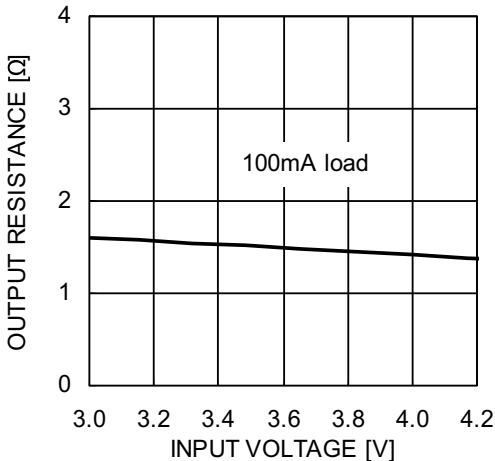

Output Resistance vs. Input Voltage (1.5x mode)

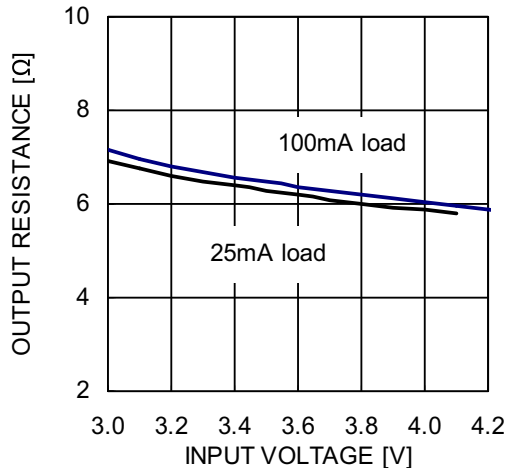

TYPICAL CHARACTERISTICS

$V_{IN} = 3.6V$, $EN = V_{IN}$, $C_{IN} = C_{OUT} = 1\mu F$, $R_{SET} = 24k\Omega$, $T_{AMB} = 25^{\circ}C$, unless otherwise specified.

Switching Waveforms in 1.5x Mode

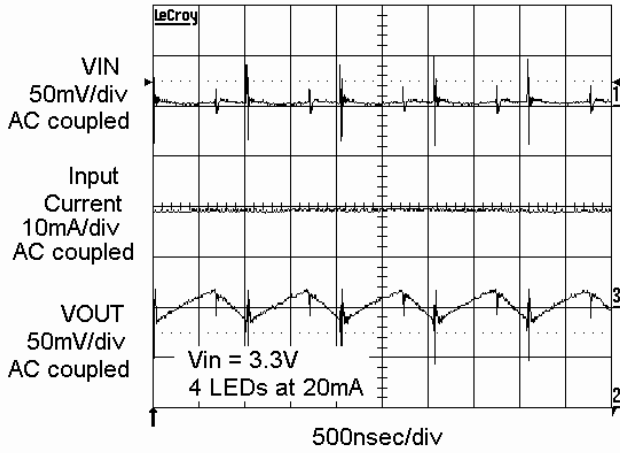

Operating Waveforms in 1x Mode

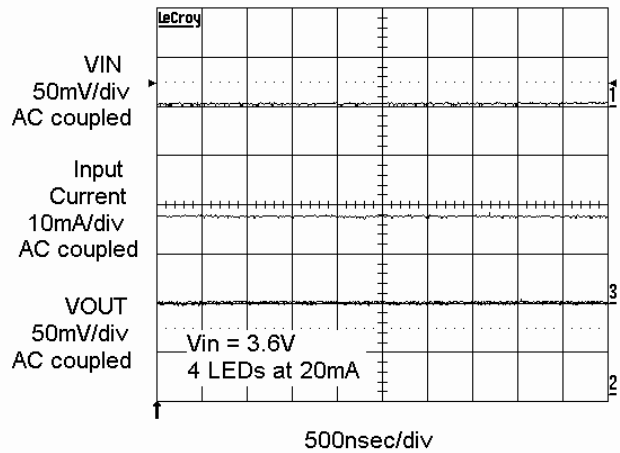

Power Up 4 LEDs at 15mA, Vin = 3V (1.5x Mode)

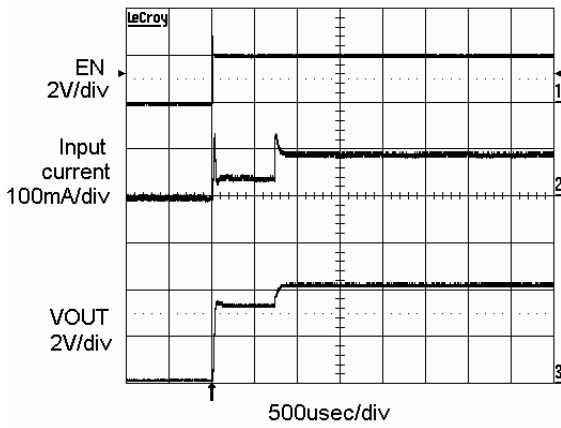

Power Up 4 LEDs at 15mA, Vin = 3.6V (1x Mode)

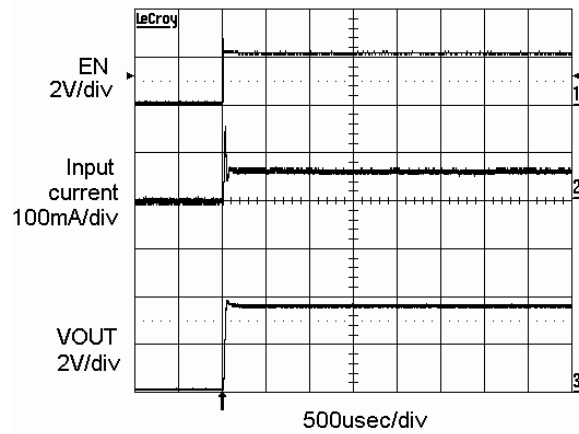

LED Current vs. RSET

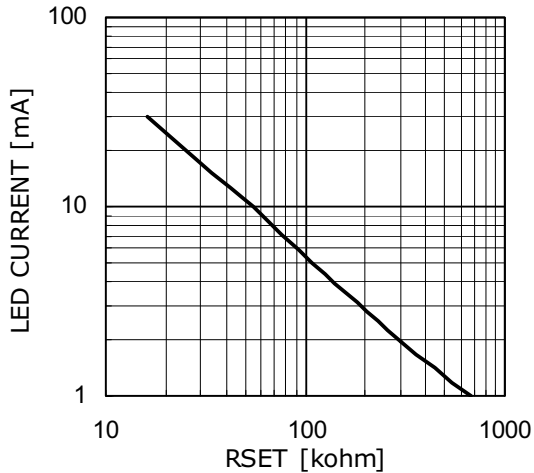

Line Transient Response in 1x Mode

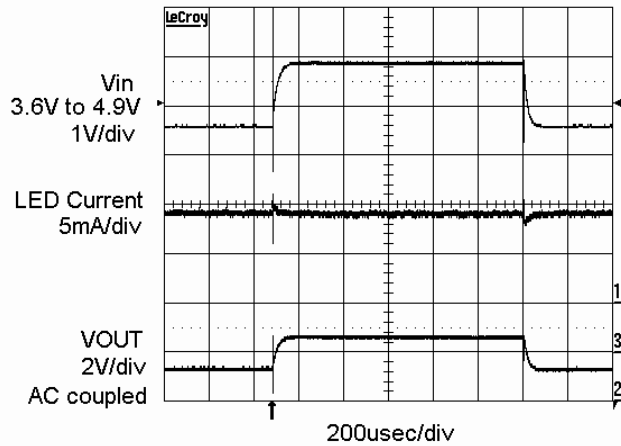

TYPICAL CHARACTERISTICS

$V_{IN} = 3.6V$, $EN = V_{IN}$, $C_{IN} = C_{OUT} = 1\mu F$, unless otherwise specified.

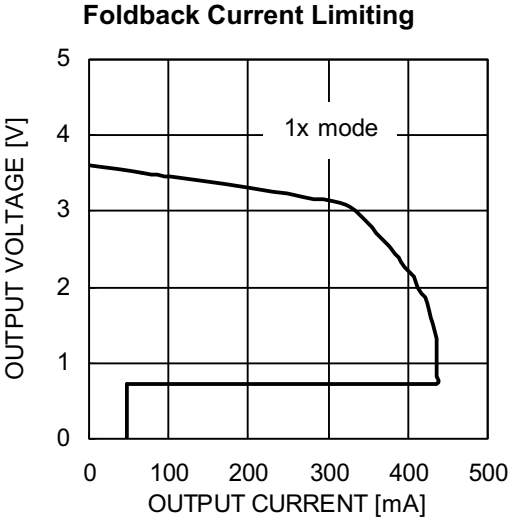

RECOMMENDED LAYOUT

When the driver is in the 1.5x charge pump mode, the 1MHz switching frequency operation requires to minimize trace length and impedance to ground on all 4 capacitors. A ground plane should cover the area on the bottom side of the PCB opposite to the IC and the bypass capacitors. Capacitors C_{in} and C_{out} require short connection to ground which can be done with multiple vias as shown on Figure 2. A

square copper area matches the QFN16 exposed pad (GND) which is connected by a trace to the pin 12 pad (GND). A large via (metalized hole) centered in the square pad provides a low impedance connection to the ground plane on the opposite side of the PCB and allows the heat dissipated by the driver IC to spread out resulting in excellent thermal performance.

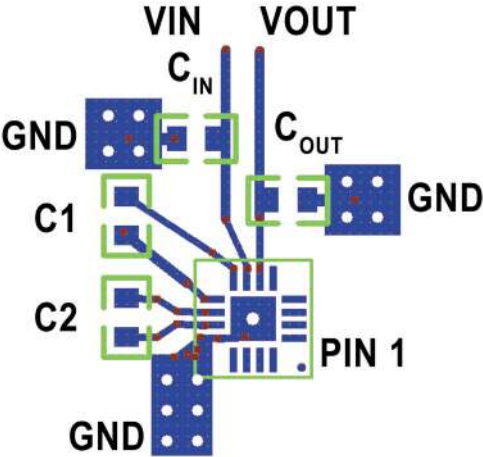

Figure 2: PCB Layout

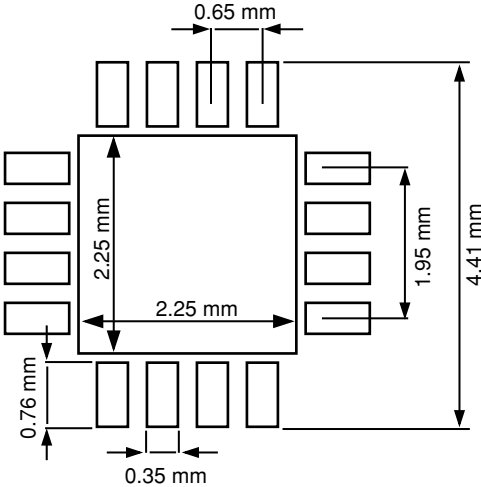
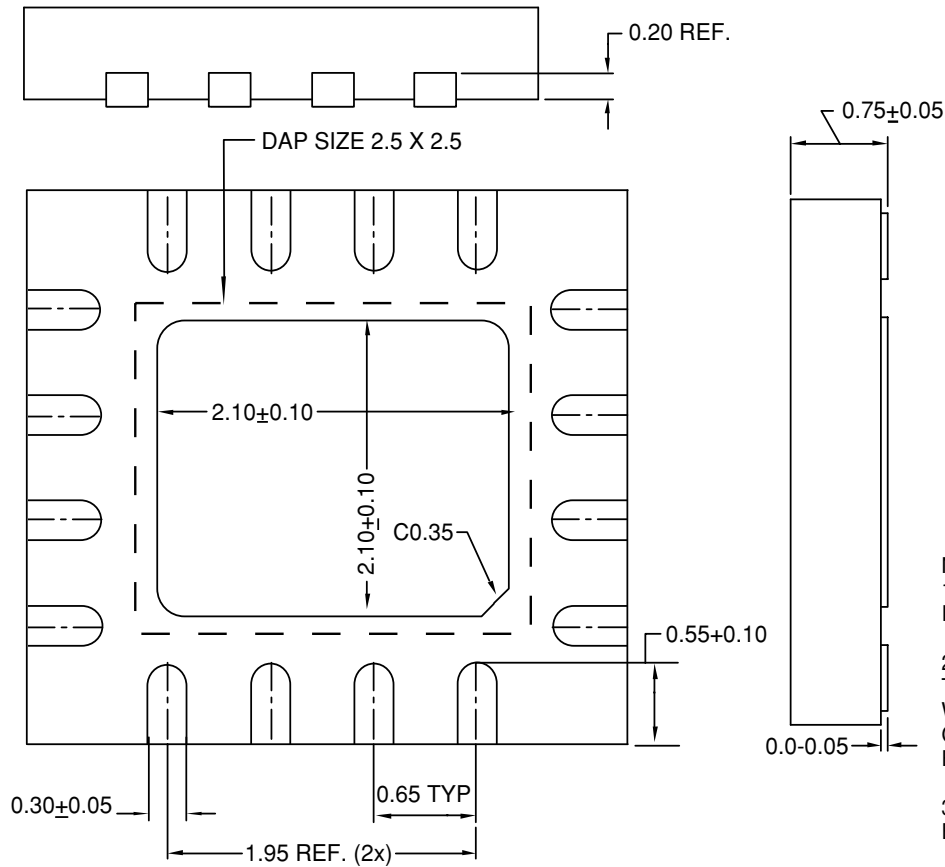
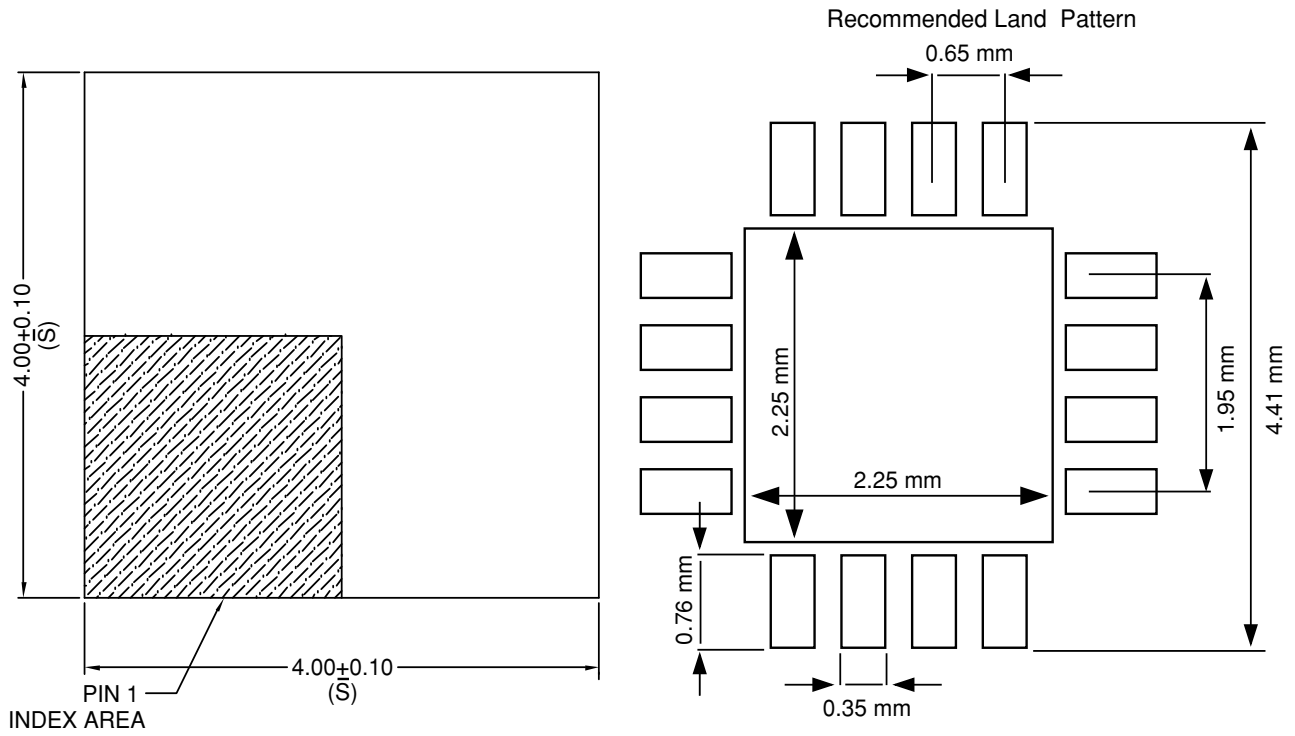

Figure 3: Recommended QFN 16 Package Land Pattern

**PACKAGE DRAWING AND DIMENSIONS
THIN QFN 16-LEAD 4MM X 4MM**



NOTE:
1. ALL DIMENSIONS ARE IN mm. ANGLES IN DEGREES.

2. COPLANARITY APPLIES TO THE EXPOSED PAD AS WELL AS THE TERMINALS. COPLANARITY SHALL NOT EXCEED 0.08mm.

3. WARPAGE SHALL NOT EXCEED 0.10mm.

4. PACKAGE LENGTH/PACKAGE WIDTH ARE CONSIDERED AS SPECIAL CHARACTERISTIC. (S)

REVISION HISTORY

Date	Rev.	Reason
8/19/2004	A	Initial issue
9/21/2004	B	Minor Changes
9/22/2004	C	Added Green package in all areas
9/29/2004	D	Minor Changes
1/4/2005	E	Added QFN land pattern (figure 3)
1/21/2005	F	Minor Changes
04/15/2005	G	Update Features Update Short Circuit Detect/Disable

Copyrights, Trademarks and Patents

Trademarks and registered trademarks of Catalyst Semiconductor include each of the following:

DPP™ AE²™

Catalyst Semiconductor has been issued U.S. and foreign patents and has patent applications pending that protect its products. For a complete list of patents issued to Catalyst Semiconductor contact the Company's corporate office at 408.542.1000.

CATALYST SEMICONDUCTOR MAKES NO WARRANTY, REPRESENTATION OR GUARANTEE, EXPRESS OR IMPLIED, REGARDING THE SUITABILITY OF ITS PRODUCTS FOR ANY PARTICULAR PURPOSE, NOR THAT THE USE OF ITS PRODUCTS WILL NOT INFRINGE ITS INTELLECTUAL PROPERTY RIGHTS OR THE RIGHTS OF THIRD PARTIES WITH RESPECT TO ANY PARTICULAR USE OR APPLICATION AND SPECIFICALLY DISCLAIMS ANY AND ALL LIABILITY ARISING OUT OF ANY SUCH USE OR APPLICATION, INCLUDING BUT NOT LIMITED TO, CONSEQUENTIAL OR INCIDENTAL DAMAGES.

Catalyst Semiconductor products are not designed, intended, or authorized for use as components in systems intended for surgical implant into the body, or other applications intended to support or sustain life, or for any other application in which the failure of the Catalyst Semiconductor product could create a situation where personal injury or death may occur.

Catalyst Semiconductor reserves the right to make changes to or discontinue any product or service described herein without notice. Products with data sheets labeled "Advance Information" or "Preliminary" and other products described herein may not be in production or offered for sale.

Catalyst Semiconductor advises customers to obtain the current version of the relevant product information before placing orders. Circuit diagrams illustrate typical semiconductor applications and may not be complete.



CATALYST

Catalyst Semiconductor, Inc.
Corporate Headquarters
1250 Borregas Avenue
Sunnyvale, CA 94089
Phone: 408.542.1000
Fax: 408.542.1200
www.catalyst-semiconductor.com

Publication #: 5008
Revision: G
Issue date: 04/15/05