

## Voltage Variable Absorptive Attenuator 12 dB, DC - 2.0 GHz

Rev. V1

### Features

- 12 dB Voltage Variable Attenuation
- Low Intermodulation Products
- Low DC Power Consumption: 50  $\mu$ W
- Single Voltage Control: 0 to -4 Volts
- Nanosecond Switching Speed
- Temperature Range: -40°C to +85°C
- Lead-Free SOIC-8 Plastic Package
- 100% Matte Tin Plating over Copper
- Halogen-Free “Green” Mold Compound
- 260°C Reflow Compatible
- RoHS\* Compliant Version of AT-250

### Description

M/A-COM’s MAAV-007941 is a GaAs MMIC voltage variable absorptive attenuator in a low cost lead-free SOIC 8-lead surface mount plastic package. The MAAV-007941 is ideally suited for use where attenuation fine tuning, fast switching and very low power consumption are required.

Typical applications include radio, cellular, GPS equipment and other automatic gain/level control circuits.

The MAAV-007941 is fabricated with a monolithic GaAs MMIC using a mature 1-micron process. The process features full chip passivation for increased performance and reliability.

### Functional Schematic

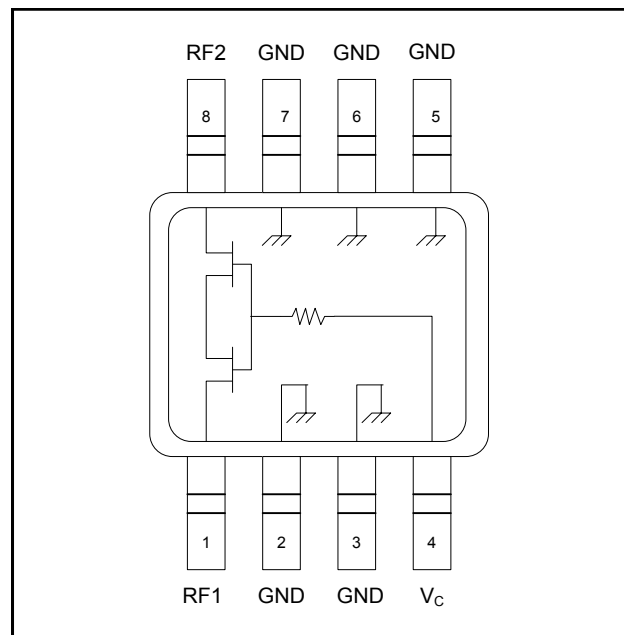

### Pin Configuration

Pin No.	Function	Pin No.	Function
1	RF1	5	Ground
2	Ground	6	Ground
3	Ground	7	Ground
4	V <sub>c</sub>	8	RF2

### Ordering Information <sup>1</sup>

Part Number	Package
MAAV-007941-000000	Bulk Packaging
MAAV-007941-TR3000	3000 piece reel

1. Reference Application Note M513 for reel size information.

### Absolute Maximum Ratings <sup>2</sup>

Parameter	Absolute Maximum
Input Power	+21 dBm
Control Voltage	+5V, -8.5V
Operating Temperature	-40°C to +85°C
Storing Temperature	-65°C to +150°C

2. Exceeding any one or combination of these limits may cause permanent damage to this device.

\* Restrictions on Hazardous Substances, European Directive 2002/95/EC.

## Voltage Variable Absorptive Attenuator 12 dB, DC - 2.0 GHz

Rev. V1

Electrical Specifications:  $T_A = 25^\circ\text{C}$ ,  $Z_0 = 50 \Omega$

Parameter	Test Conditions <sup>3</sup>	Units	Min.	Typ.	Max.
Insertion Loss	DC - 0.1 GHz	dB	—	2.9	3.1
	DC - 0.5 GHz	dB	—	3.0	3.2
	DC - 1.0 GHz	dB	—	3.2	3.5
	DC - 2.0 GHz	dB	—	3.4	3.8
Flatness (Peak to Peak)	DC - 0.1 GHz	dB	—	$\pm 0.1$	$\pm 0.3$
	DC - 0.5 GHz	dB	—	$\pm 0.2$	$\pm 0.4$
	DC - 1.0 GHz	dB	—	$\pm 0.5$	$\pm 0.8$
	DC - 2.0 GHz	dB	—	$\pm 1.2$	$\pm 1.5$
VSWR		Ratio	—	2.1:1	—
Trise, Tfall	10% to 90% RF, 90% to 10% RF	nS	—	3	—
Ton, Toff	50% Control to 90% RF, 50% Control to 10% RF	nS	—	5	—
Transients	In Band	mV	—	10	—
Power Handling	Linear Operation	dBm	—	13	—
	Absolute Maximum Input Power	dBm	—	21	—
IP <sub>2</sub>	0.05 GHz	dBm	28	34	—
	0.5 - 2.0 GHz Measured Relative to Input Power (For two-tone Input Power Up to +5 dBm)	dBm	40	47	—
IP <sub>3</sub> <sup>4</sup>	0.05 GHz	dBm	18	31	—
	0.5 - 2.0 GHz Measured Relative to Input Power (For two-tone Input Power Up to +5 dBm)	dBm	18.5	36	—

3. Control voltage: 0 to -4 volts @ 20  $\mu\text{A}$  typical.

4. Typical readings are for levels above 6 dB attenuation. For levels below 6 dB, the minimum specification numbers apply.

### Lead-Free SOIC-8<sup>†</sup>

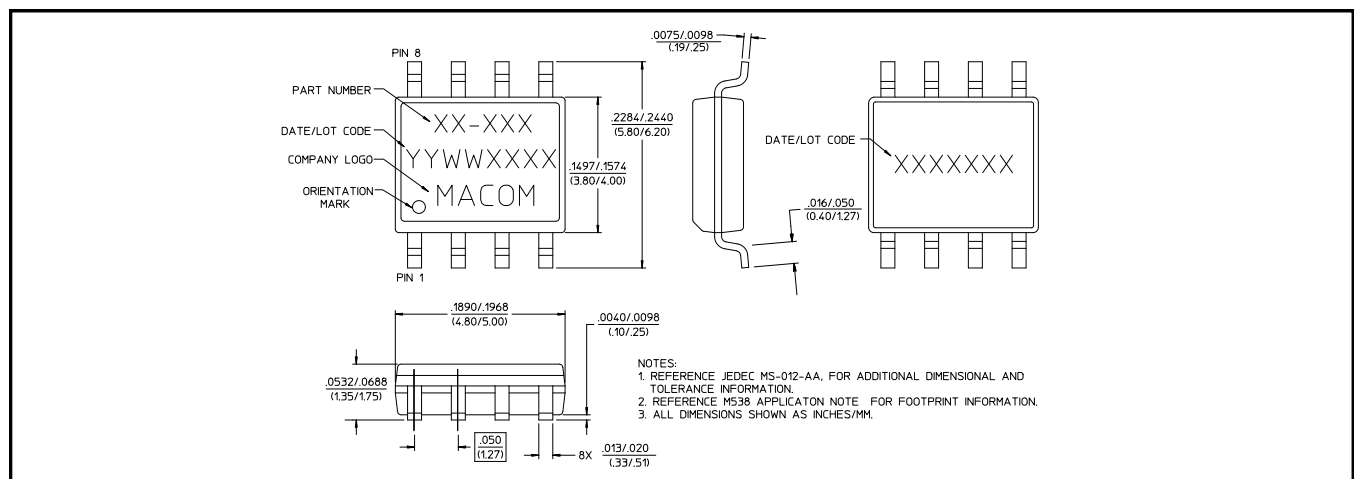

<sup>†</sup> Reference Application Note M538 for lead-free solder reflow recommendations.  
Meets JEDEC moisture sensitivity level 1 requirements.

## Voltage Variable Absorptive Attenuator 12 dB, DC - 2.0 GHz

Rev. V1

### Typical Performance Curves

**Insertion Loss vs. Frequency**

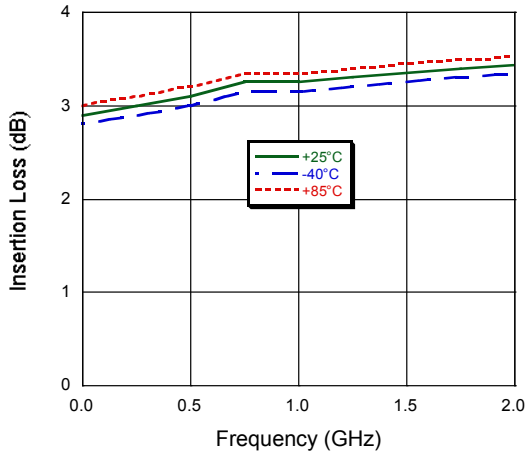

**Attenuation vs. Frequency**

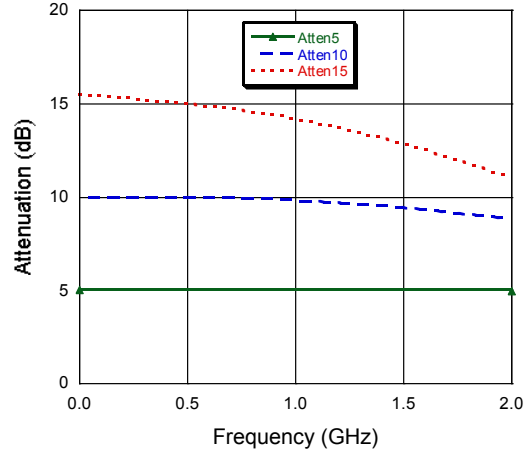

**VSWR vs. Frequency**

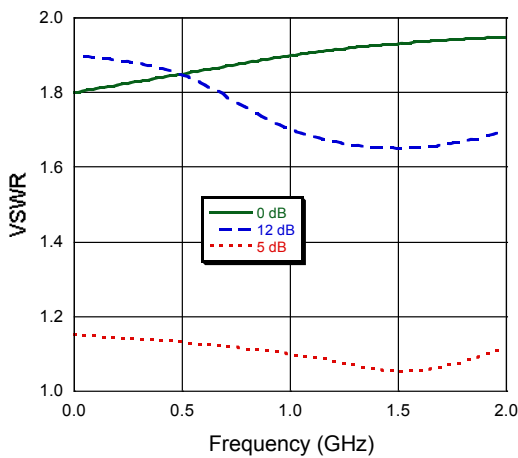

**Attenuation vs. Control Voltage, F = 950 MHz**

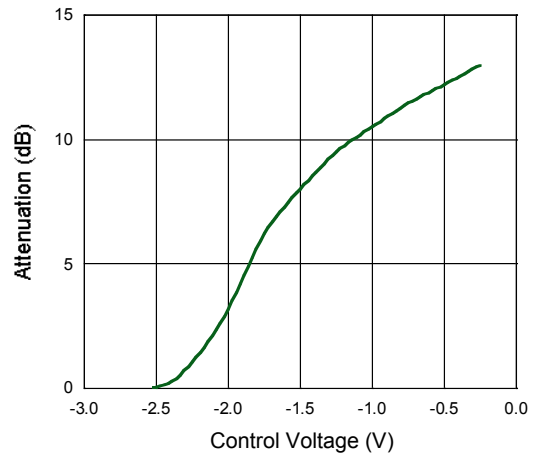

### Phas

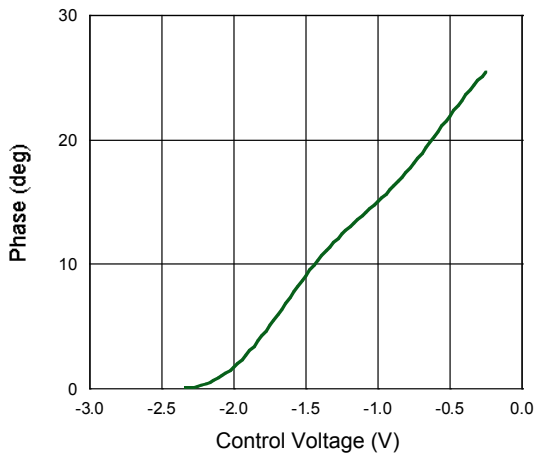

### Handling Procedures

Please observe the following precautions to avoid damage:

### Static Sensitivity

Gallium Arsenide Integrated Circuits are sensitive to electrostatic discharge (ESD) and can be damaged by static electricity. Proper ESD control techniques should be used when handling these devices.

M/A-COM Technology Solutions Inc. All rights reserved.

Information in this document is provided in connection with M/A-COM Technology Solutions Inc ("MACOM") products. These materials are provided by MACOM as a service to its customers and may be used for informational purposes only. Except as provided in MACOM's Terms and Conditions of Sale for such products or in any separate agreement related to this document, MACOM assumes no liability whatsoever. MACOM assumes no responsibility for errors or omissions in these materials. MACOM may make changes to specifications and product descriptions at any time, without notice. MACOM makes no commitment to update the information and shall have no responsibility whatsoever for conflicts or incompatibilities arising from future changes to its specifications and product descriptions. No license, express or implied, by estoppel or otherwise, to any intellectual property rights is granted by this document.

THESE MATERIALS ARE PROVIDED "AS IS" WITHOUT WARRANTY OF ANY KIND, EITHER EXPRESS OR IMPLIED, RELATING TO SALE AND/OR USE OF MACOM PRODUCTS INCLUDING LIABILITY OR WARRANTIES RELATING TO FITNESS FOR A PARTICULAR PURPOSE, CONSEQUENTIAL OR INCIDENTAL DAMAGES, MERCHANTABILITY, OR INFRINGEMENT OF ANY PATENT, COPYRIGHT OR OTHER INTELLECTUAL PROPERTY RIGHT. MACOM FURTHER DOES NOT WARRANT THE ACCURACY OR COMPLETENESS OF THE INFORMATION, TEXT, GRAPHICS OR OTHER ITEMS CONTAINED WITHIN THESE MATERIALS. MACOM SHALL NOT BE LIABLE FOR ANY SPECIAL, INDIRECT, INCIDENTAL, OR CONSEQUENTIAL DAMAGES, INCLUDING WITHOUT LIMITATION, LOST REVENUES OR LOST PROFITS, WHICH MAY RESULT FROM THE USE OF THESE MATERIALS.

MACOM products are not intended for use in medical, lifesaving or life sustaining applications. MACOM customers using or selling MACOM products for use in such applications do so at their own risk and agree to fully indemnify MACOM for any damages resulting from such improper use or sale.

4

---

M/A-COM Technology Solutions Inc. (MACOM) and its affiliates reserve the right to make changes to the product(s) or information contained herein without notice.  
Visit [www.macom.com](http://www.macom.com) for additional data sheets and product information.