



363M5K

363 Series Trimmer, 5 kOhm, 0.5 W, 1 Turns, Square Body, Vertical Shaft

Representative photograph, actual product appearance may vary.

Due to regional agency approval requirements, some products may not be available in your area. Please contact your regional Honeywell office regarding your product of choice.

Features

- 0.5 Watt
- Cermet element
- Low cost
- Superior setability and stability
- CRV to 3 % or 3 Ohms
- solid stops

Typical Applications

- Voltage divider circuits
- Telecommunications

Description

The 363 Series is a low cost, 9.53 mm (3/8 in.) square, single turn trimmer. Made in accordance to MIL-R-22097 standards, the 363 is sealed for cleaning in common solvents.

363M5K

363 Series Trimmer, 5 kOhm, 0.5 W, 1 Turns, Square Body, Vertical Shaft

Product Specifications

Product Type	Trimmer
Watts	0.5 W
Turns	1
Element Type	Cermet
Resistance Value	5 kOhm
Resistance Tolerance	± 10 %
Temperature Coefficient	± 100 ppm/ °C
Body	9,53 mm [0.375 in] square
Shaft Location	Vertical
Rotational Life	200 cycles
Series Name	363 Series
Availability	Global
UNSPSC Code	4111363300
UNSPSC Commodity	4111363300 Potentiometers

Honeywell

363M5K

363 Series Trimmer, 5 kOhm, 0.5 W, 1 Turns, Square Body, Vertical Shaft

FOR REFERENCE ONLY (MM/IN)

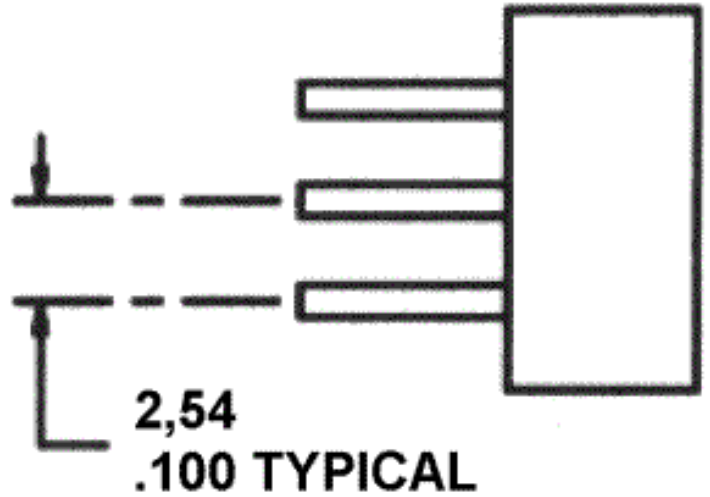
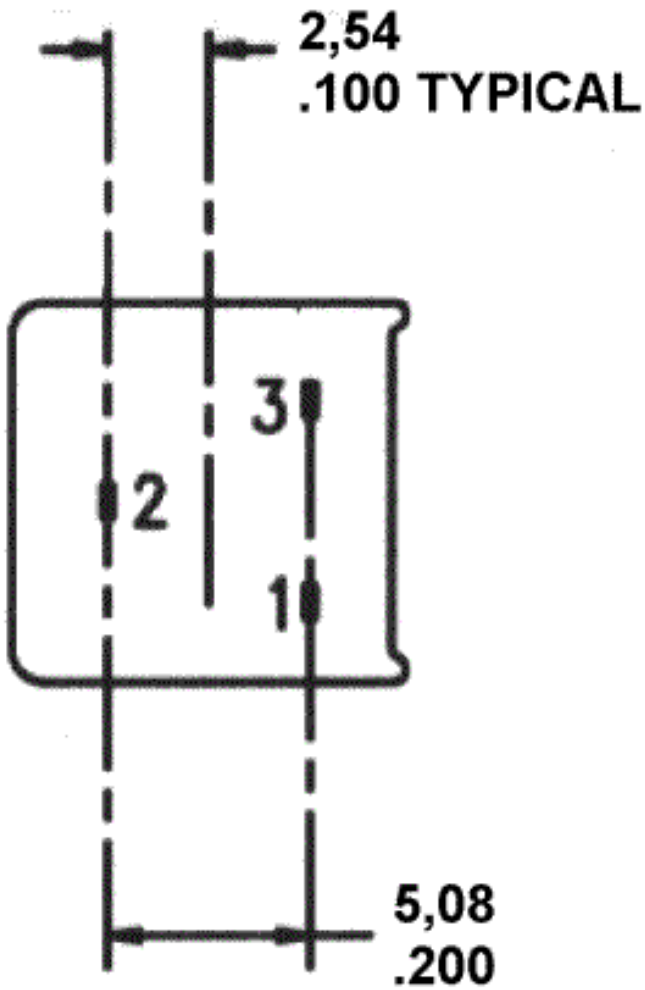

Honeywell

363M5K

363 Series Trimmer, 5 kOhm, 0.5 W, 1 Turns, Square Body, Vertical Shaft

▲ WARNING

PERSONAL INJURY

DO NOT USE these products as safety or emergency stop devices, or in any other application where failure of the product could result in personal injury.

Failure to comply with these instructions could result in death or serious injury.

 **WARNING**

MISUSE OF DOCUMENTATION

- The information presented in this product sheet (or catalog) is for reference only. DO NOT USE this document as product installation information.
- Complete installation, operation and maintenance information is provided in the instructions supplied with each product.

Failure to comply with these instructions could result in death or serious injury.