



Main

Range of Product	Modicon TM5
Product or Component Type	Analog output module
Analogue output number	4
Analogue output resolution	12 bits + sign, +/- 10 V 12 bits, 0...20 mA

Complementary

Range Compatibility	Modicon LMC058 Modicon M258
Product Compatibility	Logic controller Motion controller
Analogue output type	Current 0...20 mA Voltage +/- 10 V
Measurement resolution	4.882 mV, +/- 10 V 9.766 µA, 0...20 mA
Color	White
Response Time	<= 1 ms
Minimum output impedance	1 Ohm
Load impedance ohmic	200...500 Ohm(current)
Sampling duration	300 µs
Measurement error	< 0.08 % of full scale +/- 10 V +/- 10 V 25 °C < 0.08 % of full scale 0...20 mA 0...20 mA 25 °C
Temperature coefficient	0.015 %FS/°C current 0.015 %FS/°C voltage
Non-linearity	< 0.005 %FS current < 0.005 %FS voltage
Type of Cable	Shielded cable
Isolation	500 Vrms AC insulation between channel and bus No insulation between channels
Supply	Internal
[Us] rated supply voltage	24 V DC -15...20 %
Local signalling	1 LED green power supply 1 LED red power supply 4 LEDs yellow output status
Current consumption	2 mA 5 V DC bus 63 mA 24 V DC input/output
Maximum power dissipation in W	1.51 W
Marking	CE
Net Weight	0.06 lb(US) (0.025 kg)

Environment

Standards	IEC 61131-2 CSA C22.2 No 213 UL 508 CSA C22.2 No 142
Product Certifications	CULus GOST-R CSA C-tick
Ambient air temperature for operation	32...131 °F (0...55 °C) without derating horizontal installation) 32...140 °F (0...60 °C) with derating factor horizontal installation) 32...122 °F (0...50 °C) vertical installation)
Ambient Air Temperature for Storage	-13...158 °F (-25...70 °C)
Relative humidity	5...95 % without condensation
IP degree of protection	IP20IEC 61131-2
Pollution degree	2 IEC 60664
Operating altitude	0...6561.68 ft (0...2000 m)
Storage altitude	0.00...9842.52 ft (0...3000 m)
Vibration resistance	1 gn 8.4...150 Hz DIN rail 3.5 mm 5...8.4 Hz DIN rail
Shock resistance	15 gn 11 ms
Resistance to electrostatic discharge	4 KV on contact EN/IEC 61000-4-2 8 kV in air EN/IEC 61000-4-2
Resistance to electromagnetic fields	0.91 V/m (1 V/m) 2...2.7 GHz EN/IEC 61000-4-3 9.14 V/m (10 V/m) 80...2000 MHz EN/IEC 61000-4-3
Resistance to fast transients	1 KV EN/IEC 61000-4-4 I/O) 1 KV EN/IEC 61000-4-4 shielded cable) 2 kV EN/IEC 61000-4-4 power lines)
Surge withstand	0.5 KV differential mode EN/IEC 61000-4-5 1 kV common mode EN/IEC 61000-4-5
Electromagnetic compatibility	EN/IEC 61000-4-6
Disturbance radiated/conducted	CISPR 11

Ordering and shipping details

Category	22532 - M258 PLC
Discount Schedule	PC12
GTIN	3595864074818
Nbr. of units in pkg.	1
Package weight(Lbs)	1.51 oz (42.9 g)
Returnability	Yes
Country of origin	AT

Packing Units

Unit Type of Package 1	PCE
Package 1 Height	0.79 in (2 cm)
Package 1 width	2.36 in (6 cm)
Package 1 Length	4.33 in (11 cm)
Unit Type of Package 2	S02
Number of Units in Package 2	97
Package 2 Weight	9.19 lb(US) (4.17 kg)
Package 2 Height	5.91 in (15 cm)
Package 2 width	11.81 in (30 cm)
Package 2 Length	15.75 in (40 cm)

Offer Sustainability

Sustainable offer status	Green Premium product
California proposition 65	WARNING: This product can expose you to chemicals including: Lead and lead compounds, which is known to the State of California to cause cancer and birth defects or other reproductive harm. For more information go to www.P65Warnings.ca.gov
REACH Regulation	REACH Declaration
REACH free of SVHC	Yes
EU RoHS Directive	Pro-active compliance (Product out of EU RoHS legal scope) EU RoHS Declaration
Toxic heavy metal free	Yes
Mercury free	Yes
RoHS exemption information	Yes
China RoHS Regulation	China RoHS Declaration
Environmental Disclosure	Product Environmental Profile
Circularity Profile	End Of Life Information
WEEE	The product must be disposed on European Union markets following specific waste collection and never end up in rubbish bins.
PVC free	Yes

Contractual warranty

Warranty	18 months
----------	-----------

TM5 Slice

Dimensions

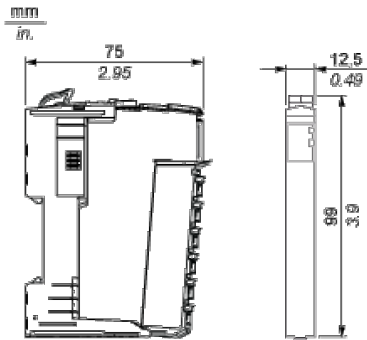

TM5 System

Spacing Requirements

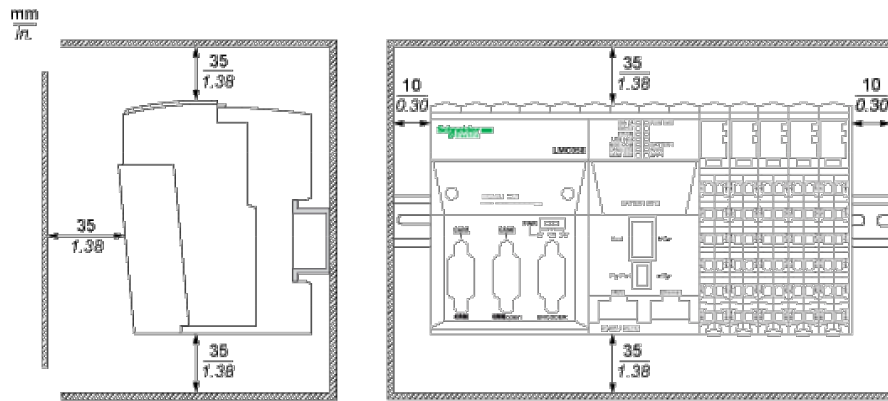

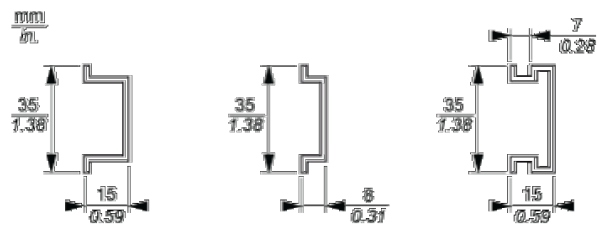

Mounting on a DIN Rail



TM5 System Wiring Recommendations

Wire Sizes to Use with the Removable Spring Terminal Blocks

mm in				
mm ²	0,08...2,5	0,25...2,5	0,25...1,5	2 x 0,25...2 x 0,75
AWG	28...14	24...14	24...16	2 x 24...2 x 18

Electronic Module 4AO ±10V/0-20mA 12 Bits

Wiring Diagram

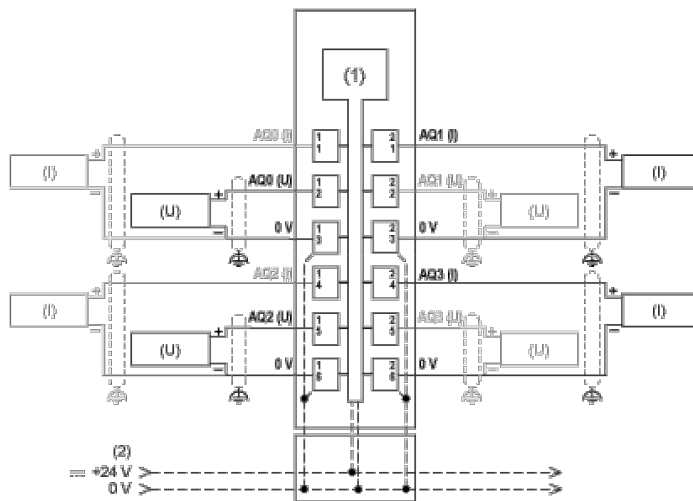

- (1) Internal electronics
- (2) 24 Vdc I/O power segment integrated into the bus bases
- (I) Current
- (U) Voltage