

WORLD-BEAM® QS18AF Mechanically Adjustable Background Suppression Sensor (30-300mm)

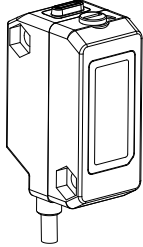

Datasheet

Compact sensors featuring extended range and background suppression mode



- Exceptional optical performance; up to 300 mm sensing range in compact QS18 housing
- Background suppression models for reliable detection of objects when the background condition is not controlled or fixed
- Simple multi-turn screw adjustment of cutoff distance
- Enhanced immunity to fluorescent lights
- Crosstalk immunity algorithm allows two sensors to be used in close proximity
- Visible red emitter



WARNING: Not To Be Used for Personnel Protection

Never use this device as a sensing device for personnel protection. Doing so could lead to serious injury or death. This device does not include the self-checking redundant circuitry necessary to allow its use in personnel safety applications. A sensor failure or malfunction can cause either an energized or de-energized sensor output condition.

Models

Models ¹	Supply Voltage	Sensing Range	Output Type
QS18VN6AF300	10 to 30 V dc	Adjustable Cutoff: 30 to 300 mm Minimum sensing range 4 to 10 mm depending on cutoff	NPN
QS18VP6AF300			PNP
QS18AB6AF300			Bipolar (1 NPN & 1 PNP)

Overview

WORLD-BEAM® QS18 Adjustable-Field Sensors with Background Suppression ignore objects beyond the set cutoff distance. Background suppression mode can be used in most situations with varying object color and position or with varying background conditions.

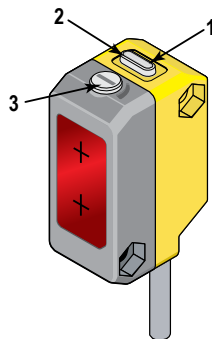

1	Green: Power Indicator
2	Yellow: Light Sensed Indicator (Flashes for Marginal Conditions)
3	Cutoff Point Adjustment Screw

Figure 1. Sensor features

¹ Only standard 2 m (6.5 ft) cable models are listed.

- To order 9 m (30 ft) cable models: add suffix "W/30" to the model number (for example, QS18VN6AF300 W/30).
- To order 150 mm (6 in) pigtail with a 4-pin Pico-style connector models, add suffix "Q" to the model number (for example, QS18VN6AF300Q)
- To order 150 mm (6 in) pigtail with a 4-pin Euro-style connector models, add suffix "Q5" to the model number (for example, QS18VN6AF300Q5)



Sensor Orientation

To ensure reliable detection, orient the sensor as shown in relation to the target to be detected.

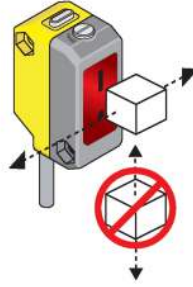
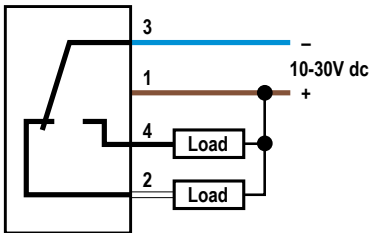

Figure 2. Optimal Orientation of Target to Sensor

Wiring Diagrams

Cabled wiring diagrams are shown. Quick disconnect (QD) wiring diagrams are functionally identical.

NPN (Sinking) Outputs



PNP (Sourcing) Outputs

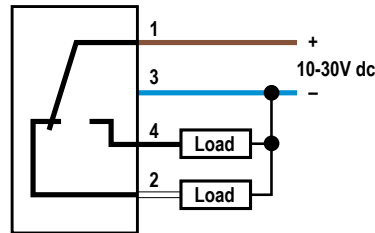

Wiring Key

- 1 = Brown
- 2 = White
- 3 = Blue
- 4 = Black

Bipolar Outputs

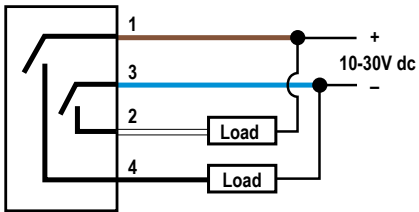

Sensor Setup - Background Suppression

Background Suppression Mode: Objects beyond the set cutoff distance will not be detected.

Background suppression mode can be used in most situations with varying object colors and positions or with varying background conditions.

To ensure reliable background suppression, a minimum separation distance between the object and the background is necessary. See [Figure 7](#) on page 5 to determine the minimum separation distance.

1. Mount the sensor with the darkest object at the longest application distance. The distance to the object must be less than shown in [Figure 7](#) on page 5 for your object color.
2. Turn the adjustment potentiometer **counter-clockwise** until the yellow indicator turns **off** (5 turns maximum).
3. Turn the adjustment potentiometer **clockwise** until the yellow indicator turns **on**.
4. Replace the darkest object with the brightest background at the closest application distance.
5. Turn the adjustment potentiometer **clockwise**, counting the revolutions, until the yellow indicator turns **on**.
6. Turn the adjustment potentiometer **counter-clockwise** half of the number of turns from step 5. This places the cutoff distance midway between the object and the background switchpoints (see [Figure 3](#) on page 3).

The sensor is ready for operation.

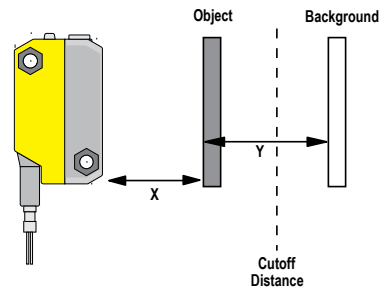

X: Distance to the Object

Y: Minimum Separation Between the Object and the Background

Figure 3.

Set the cutoff distance approximately midway between the farthest object and the closest background

Setup Example

An object with a reflectivity similar to black paper is set 150 mm away from the sensor. A background with a reflectivity similar to white paper is set 200 mm away from the sensor. According to [Figure 7](#) on page 5, the minimum separation distance between the object and the background is 12 mm. In this application, reliable detection is achieved when set up according to the procedure outlined in [Sensor Setup - Background Suppression](#) on page 2.

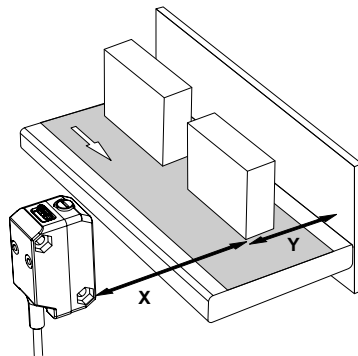

Figure 4. Background Suppression Mode Application Example

1. Object
 2. Conveyor
 3. Background
- X: Distance to the Object = 150 mm
 Y: Minimum Separation Between the Object and the Background > 12 mm

Output States

Background Suppression Mode				
Sensor Model Type	Output	Object Inside Minimum Sensing Range	Object Between Minimum Sensing Range and Cutoff Distance	Object Beyond Cutoff Distance
All Models	Yellow Indicator Light	Undefined	ON	OFF
Complementary Models	Black Wire (Pin 4)	Undefined	ON	OFF
	White Wire (Pin 2)	Undefined	OFF	ON
Bipolar Models	Black Wire (Pin 4)	Undefined	ON	OFF
	White Wire (Pin 2)	Undefined	ON	OFF

Specifications

Supply Voltage

10 to 30 V dc (10% maximum ripple within specified limits) at less than 16 mA, exclusive of load

Sensing Beam

Visible red LED, 640 nm

Supply Protection Circuitry

Protected against reverse polarity and transient voltages

Output Configuration

Solid-state complementary: NPN or PNP (current sinking or sourcing), or bipolar (both sinking and sourcing) depending on model;
Rating: 100 mA total output current

Off-state leakage current: < 50 µA at 30 V dc

ON-state saturation voltage: < 1.5 V at 10 mA; < 3.0 V at 100 mA

Protected against false pulse on power-up and continuous overload or short circuit of outputs

Required Overcurrent Protection



WARNING: Electrical connections must be made by qualified personnel in accordance with local and national electrical codes and regulations.

Overcurrent protection is required to be provided by end product application per the supplied table.
Overcurrent protection may be provided with external fusing or via Current Limiting, Class 2 Power Supply.
Supply wiring leads < 24 AWG shall not be spliced.
For additional product support, go to www.bannerengineering.com.

Supply Wiring (AWG)	Required Overcurrent Protection (Amps)
20	5.0
22	3.0
24	2.0
26	1.0
28	0.8
30	0.5

Output Response

2.8 millisecond ON/OFF

Note: 200 millisecond delay on power-up; outputs do not conduct during this time

Adjustments

Five-turn adjustment screw sets cutoff distance between min. and max. positions, clutched at both ends of travel

Repeatability

250 µs

Indicators

2 LED indicators on sensor top:

Green solid: Power on

Amber solid: Light sensed

Amber flashing: Marginal sensing condition

Construction

ABS housing, acrylic lens cover; PVC cable, nickel-plated brass connector, acetal adjustment pot

Environmental Rating

IEC IP67; NEMA 6; UL Type 1

Connections

2 m (6.5 ft) 4-wire PVC cable, 9 m (30 ft) PVC cable, or 4-pin Pico-style or Euro-style 150 mm (6 in) pigtail QD, depending on model

Operating Conditions

Relative Humidity: 95% relative humidity at 50 °C (non-condensing)

Temperature: -20 °C to 55 °C (-4 °F to 131 °F)

Application Notes

For mirror-like objects, minimize the sensor to object mounting distance and tilt the sensor so reflected light is directed away from the sensor when the object is present.

Certifications



Performance Curves

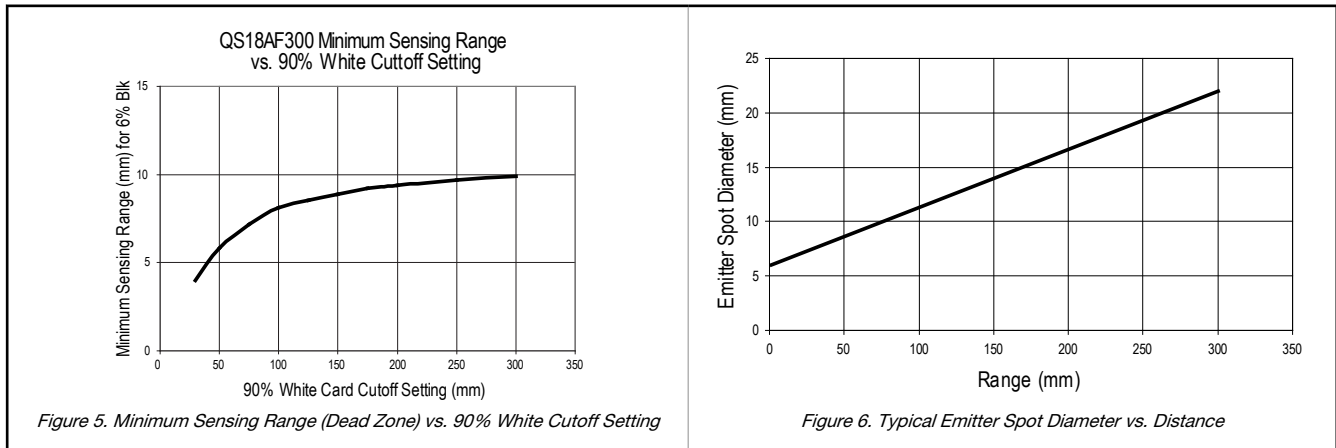

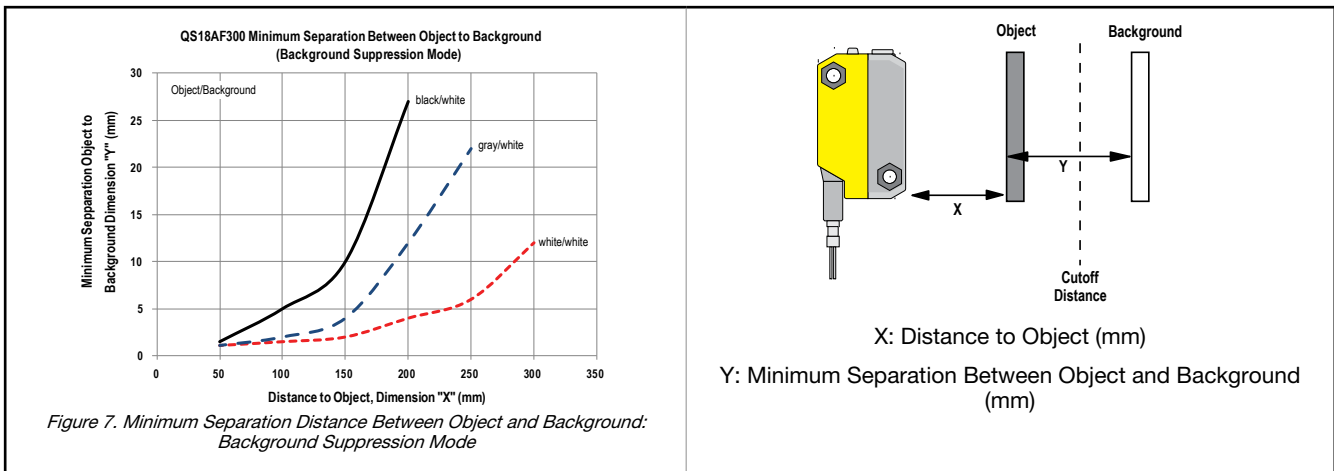

Excess Gain Curves

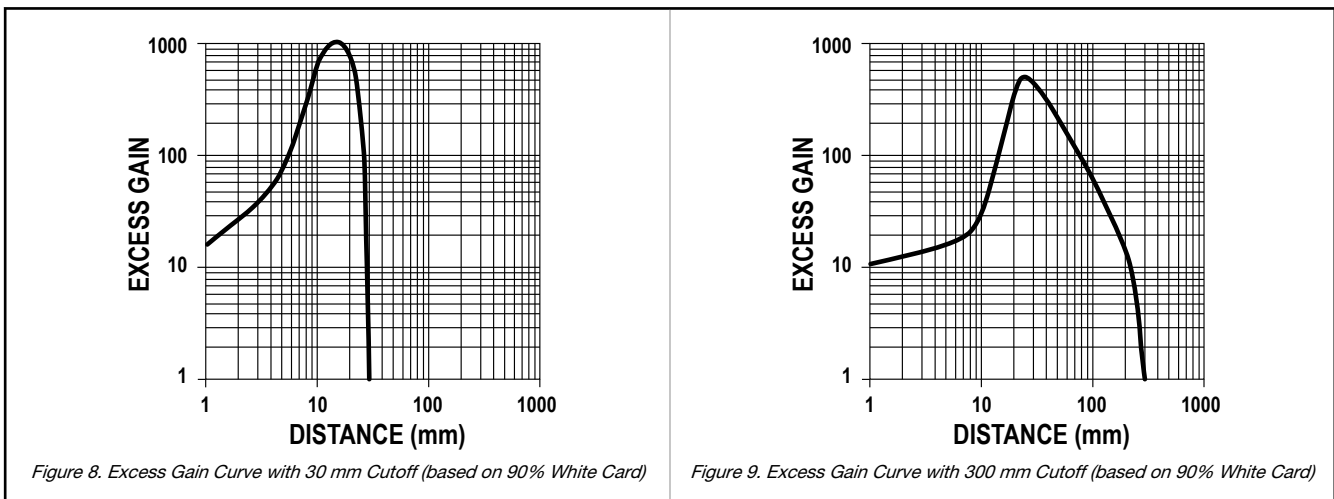

Dimensions

All measurements are listed in millimeters [inches], unless noted otherwise.

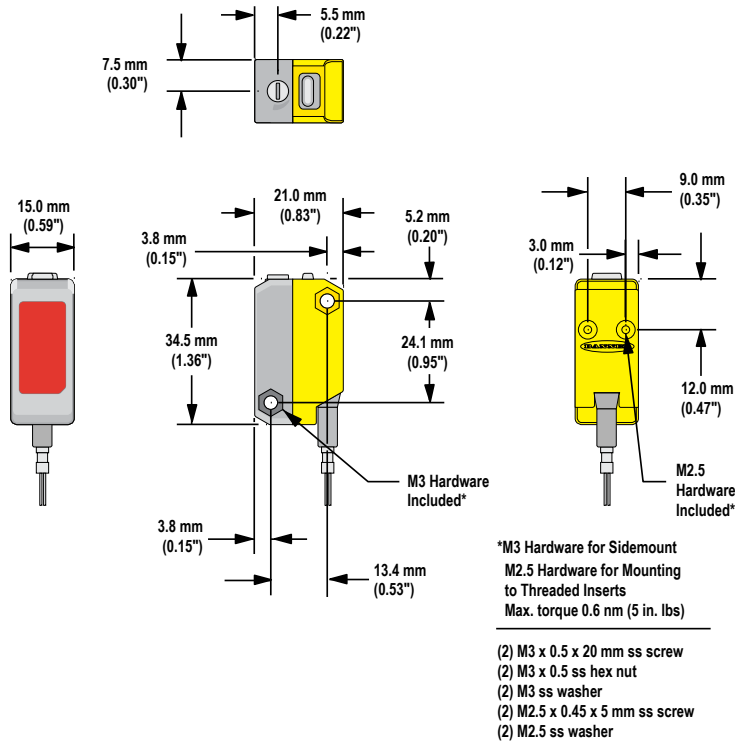

Accessories

Quick-Disconnect (QD) Cordsets

4-Pin Snap-on M8/Pico-Style Cordsets				
Model	Length	Style	Dimensions	Pinout (Female)
PKG4-2	2 m (6.56 ft)	Straight		<p>1 = Brown 2 = White 3 = Blue 4 = Black</p>

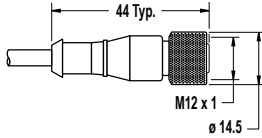
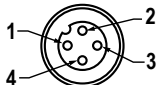
4-Pin Threaded M12/Euro-Style Cordsets				
Model	Length	Style	Dimensions	Pinout (Female)
MQDC-406	1.83 m (6 ft)	Straight		 <p>1 = Brown 2 = White 3 = Blue 4 = Black</p>
MQDC-415	4.57 m (15 ft)			
MQDC-430	9.14 m (30 ft)			
MQDC-450	15.2 m (50 ft)			

Mounting Brackets

All measurements are listed in millimeters, unless noted otherwise.

SMBQS18A

- Wrap-around protection bracket
- Die-cast bracket
- Base fits 18 mm threaded hole
- Metal hex nut, lock washer and grommet included
- Mounting holes specially designed for QS18AF sensors

Hole size: A = ø 15.3

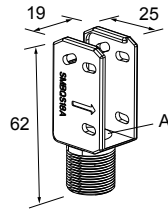

SMBQS18AF

- Right-angle mounting bracket
- 14-ga. 304 stainless steel

Hole center spacing: A to B = 20.3

Hole size: A = 4.3 x 9.4, B = ø 4.3

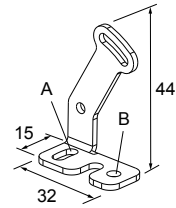

Banner Engineering Corp. Limited Warranty

Banner Engineering Corp. warrants its products to be free from defects in material and workmanship for one year following the date of shipment. Banner Engineering Corp. will repair or replace, free of charge, any product of its manufacture which, at the time it is returned to the factory, is found to have been defective during the warranty period. This warranty does not cover damage or liability for misuse, abuse, or the improper application or installation of the Banner product.

THIS LIMITED WARRANTY IS EXCLUSIVE AND IN LIEU OF ALL OTHER WARRANTIES WHETHER EXPRESS OR IMPLIED (INCLUDING, WITHOUT LIMITATION, ANY WARRANTY OF MERCHANTABILITY OR FITNESS FOR A PARTICULAR PURPOSE), AND WHETHER ARISING UNDER COURSE OF PERFORMANCE, COURSE OF DEALING OR TRADE USAGE.

This Warranty is exclusive and limited to repair or, at the discretion of Banner Engineering Corp., replacement. **IN NO EVENT SHALL BANNER ENGINEERING CORP. BE LIABLE TO BUYER OR ANY OTHER PERSON OR ENTITY FOR ANY EXTRA COSTS, EXPENSES, LOSSES, LOSS OF PROFITS, OR ANY INCIDENTAL, CONSEQUENTIAL OR SPECIAL DAMAGES RESULTING FROM ANY PRODUCT DEFECT OR FROM THE USE OR INABILITY TO USE THE PRODUCT, WHETHER ARISING IN CONTRACT OR WARRANTY, STATUTE, TORT, STRICT LIABILITY, NEGLIGENCE, OR OTHERWISE.**

Banner Engineering Corp. reserves the right to change, modify or improve the design of the product without assuming any obligations or liabilities relating to any product previously manufactured by Banner Engineering Corp. Any misuse, abuse, or improper application or installation of this product or use of the product for personal protection applications when the product is identified as not intended for such purposes will void the product warranty. Any modifications to this product without prior express approval by Banner Engineering Corp will void the product warranties. All specifications published in this document are subject to change; Banner reserves the right to modify product specifications or update documentation at any time. Specifications and product information in English supersede that which is provided in any other language. For the most recent version of any documentation, refer to: www.bannerengineering.com.