

ZWS SERIES

Single Output 5W - 300W

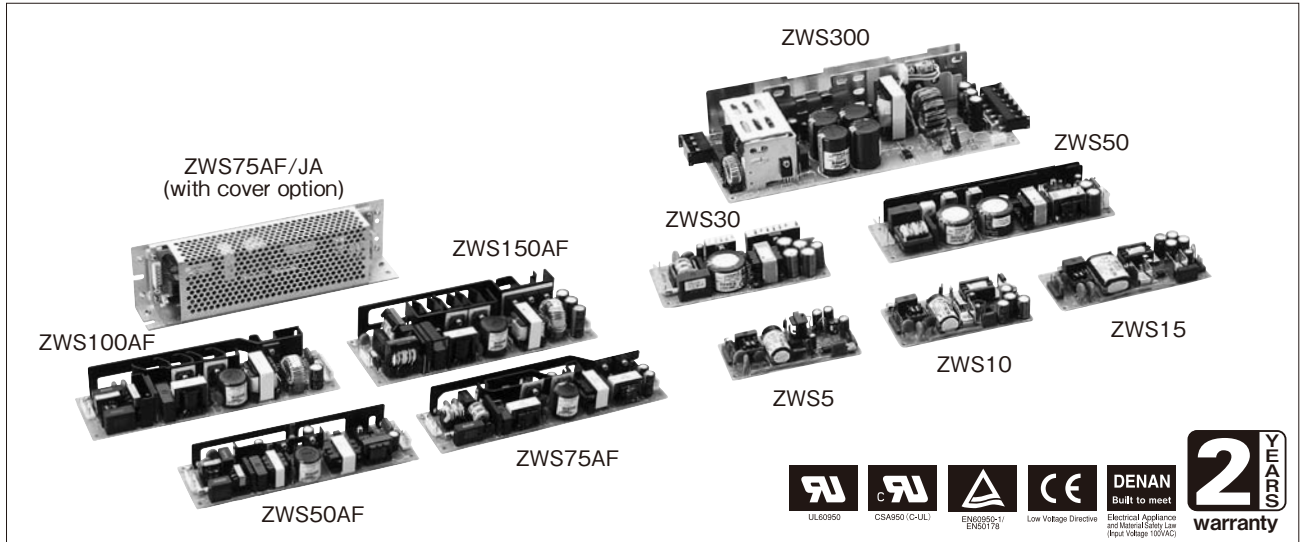

Features

CE marking applicable

- Full line-up from 5W through 300W
- Small leak current: 0.5mA max (ZWS-AF)
- ON/OFF control/output voltage trimmer (ZWS-AF)
- Applicable to a wide range of usages, including printers for business use and air conditioners
- Complies the harmonics current limit standard by built-in active filter (ZWS-AF)

Applications

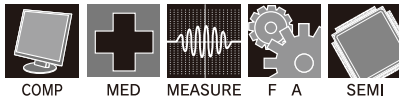

Model naming method

ZWS 10-5/□□

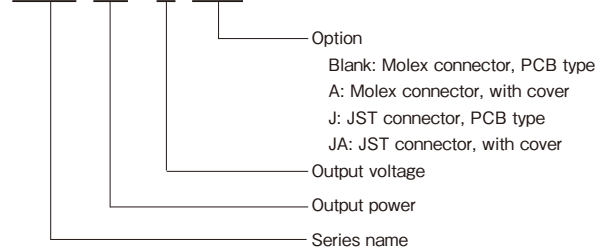

ZWS 300-5/□□

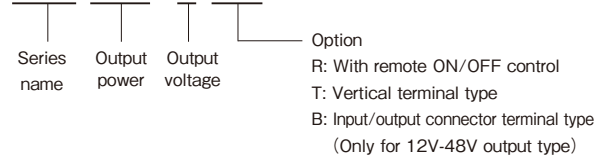

Conformity to RoHS Directive

This means that, in conformity with EU Directive 2002/95/EC, lead, cadmium, mercury, hexavalent chromium, and specific bromine-based flame retardants, PBB and PBDE, have not been used, except for exempted applications.

Product Line up

ZWS (Single Output) * In case of new design is required, please refer to ZWS-AF series.

Output Voltage	5W		10W		15W		30W		50W		300W	
	Current(Peak)	Model	Current(Peak)	Model	Current(Peak)	Model	Current(Peak)	Model	Current(Peak)	Model	Current(Peak)	Model
3.3V	1.0A (1.2)	ZWS5-3	2.0A (2.4)	ZWS10-3	3.0A (3.6)	ZWS15-3	6.0A (7.2)	ZWS30-3	10A (12)	ZWS50-3	40A (60)	ZWS300-3
		ZWS5-5		ZWS10-5		ZWS15-5		ZWS30-5		ZWS50-5		ZWS300-5
12V	0.42A (0.51)	ZWS5-12	0.85A (1.02)	ZWS10-12	1.25A (1.5)	ZWS15-12	2.5A (3.0)	ZWS30-12	4.3A (5.16)	ZWS50-12	17A (27)	ZWS300-12
15V	0.34A (0.41)	ZWS5-15	0.7A (0.84)	ZWS10-15	1.0A (1.2)	ZWS15-15	2.0A (2.4)	ZWS30-15	3.5A (4.2)	ZWS50-15	14A (22)	ZWS300-15
24V	0.22A (0.27)	ZWS5-24	0.45A (0.54)	ZWS10-24	0.65A (0.78)	ZWS15-24	1.3A (1.56)	ZWS30-24	2.1A (2.52)	ZWS50-24	9A (14)	ZWS300-24
36V	-	-	-	-	-	-	0.9A (1.08)	ZWS30-36	1.4A (1.68)	ZWS50-36	-	-
48V	-	-	-	-	-	-	0.7A (0.84)	ZWS30-48	1.1A (1.32)	ZWS50-48	4.2A (6.3)	ZWS300-48

ZWS-AF (Single Output, Built-in Active Filter)

Output Voltage	50W		75W		100W		150W	
	Current(Peak)	Model	Current(Peak)	Model	Current(Peak)	Model	Current(Peak)	Model
5V	10A (-)	ZWS50AF-5	15A (-)	ZWS75AF-5	20A (-)	ZWS100AF-5	30A (-)	ZWS150AF-5
12V	4.3A (5.2)	ZWS50AF-12	6.3A (7.5)	ZWS75AF-12	8.5A (10)	ZWS100AF-12	12.5A (15)	ZWS150AF-12
15V	3.5A (4.2)	ZWS50AF-15	5.0A (6.0)	ZWS75AF-15	6.7A (8.0)	ZWS100AF-15	10A (12)	ZWS150AF-15
24V	2.1A (2.6)	ZWS50AF-24	3.2A (3.8)	ZWS75AF-24	4.3A (5.0)	ZWS100AF-24	6.3A (7.5)	ZWS150AF-24

ZWS5 Specifications

ITEMS/UNITS		MODEL	ZWS5-3	ZWS5-5	ZWS5-12	ZWS5-15	ZWS5-24
Input	Voltage Range	(*3) V	AC85 - 265 or DC110 - 330				
	Frequency	(*3) Hz	47 - 440				
	Efficiency (typ)	(*2) %	62	67	68	70	
	Current (100/200VAC)(typ)	A	0.14 / 0.07				
	Inrush Current (100/200VAC)(typ)	A	15 / 30 at Ta=25°C, cold start				
Output	Nominal Voltage	V	3.3	5	12	15	24
	Minimum Current	A	0				
	Maximum Current	A	1		0.42	0.34	0.22
	Maximum Peak Current	(*1) A	1.2		0.51	0.41	0.27
	Maximum Power	W	3.3	5.0	5.04	5.1	5.28
	Maximum Peak Power	(*1) W	3.96	6.0	6.048	6.12	6.336
	Maximum Line Regulation	(*4)(*10) mV	20		48	60	96
	Maximum Load Regulation	(*5)(*10) mV	40		96	120	150
	Temperature Coefficient	(*6) mV	60		140	180	280
	Maximum Ripple & Noise (0 to +60°C)(*10)	mVp-p	120		150		200
	Maximum Ripple & Noise (-10 to 0°C)(*10)	mVp-p	160		180		200
	Hold-up Time (100VAC)(typ)	(*2) ms	17 at 5W, Ta=25°C				
Function	Voltage Adjustable Range		+/-10%				
	Over Current Protection	(*7)	>125%				
	Over Voltage Protection	(*8)	>140%				
	Parallel Operation		-				
	Series Operation	(*9)	Possible				
Environment	Operating Temperature	(*11) °C	-10 to +50: 100%, +60: 70%				
	Storage Temperature	°C	-30 to +85				
	Operating Humidity	%RH	30 - 90				
	Storage Humidity	%RH	10 - 95				
	Vibration		10-55Hz (sweep 1min) less than 19.6m/s ² X, Y, Z 1h each				
	Shock		Less than 196.1m/s ²				
Isolation	Cooling		Convection cooling				
	Withstand Voltage		Input - FG: 2kVAC (20mA), Input - Output: 3kVAC (20mA), Output - FG: 500VAC (100mA) for 1min				
Standards	Isolation Resistance		More than 100MΩ at 25°C and 70%RH Output - FG 500VDC				
	Safety Standards		Approved by UL60950-1, CSA C22.2 No.60950-1, EN60950-1, Built to meet DENAN				
Mechanical	EMI		Built to meet EN55022-B, FCC-ClassB, VCCI-B				
	Weight (typ)	g	120				
	Size (W x H x D)	mm	45 x 21 x 98				

- (*1) Operating time at peak output is less than 10 seconds. (Duty=0.35)
- (*2) At 100VAC and maximum output current, Ta=25°C.
- (*3) For cases where conformance to various safety specs (UL, CSA) are required, to be described as 100 - 240VAC, 50/60Hz on name plate.
- (*4) From 85 - 265VAC and constant load.
- (*5) From min load - full load (maximum power) and constant input voltage.
- (*6) From -10 to +50°C constant input voltage and load.
- (*7) Current limiting with automatic recovery. Avoid to operate over load or dead short for 30 seconds.
- (*8) Over voltage clamping by zener diode.
- (*9) Refer to instruction manual.
- (*10) Please refer to Fig A for measurement of line & load regulation and ripple voltage.
- (*11) At standard mounting method, Fig B.

Recommended EMC Filter

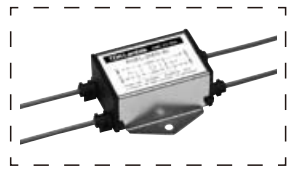

RSEL-20R5W
Please refer to "TDK-Lambda EMC Filters" catalog.

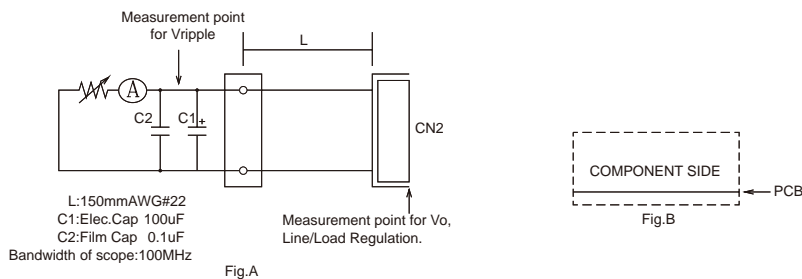

Outline Drawing

[ZWS5 (Standard : MOLEX connector)]

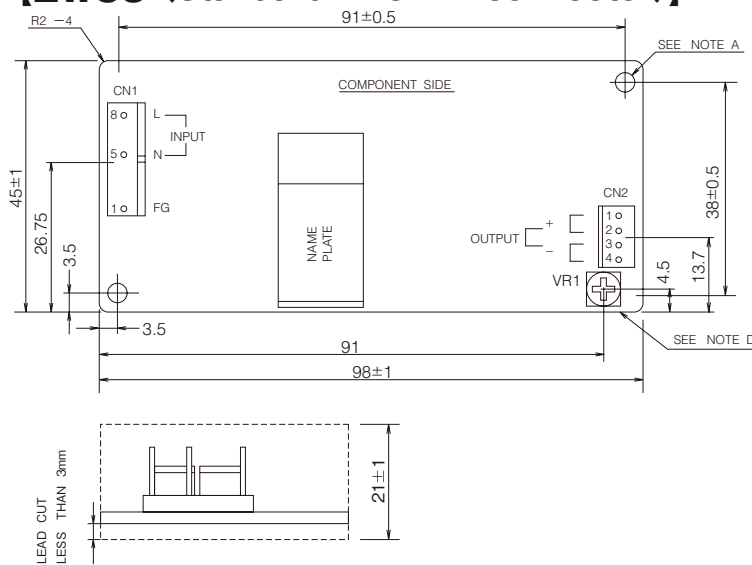

(unit : mm)

[ZWS5 (/J : JST connector)]

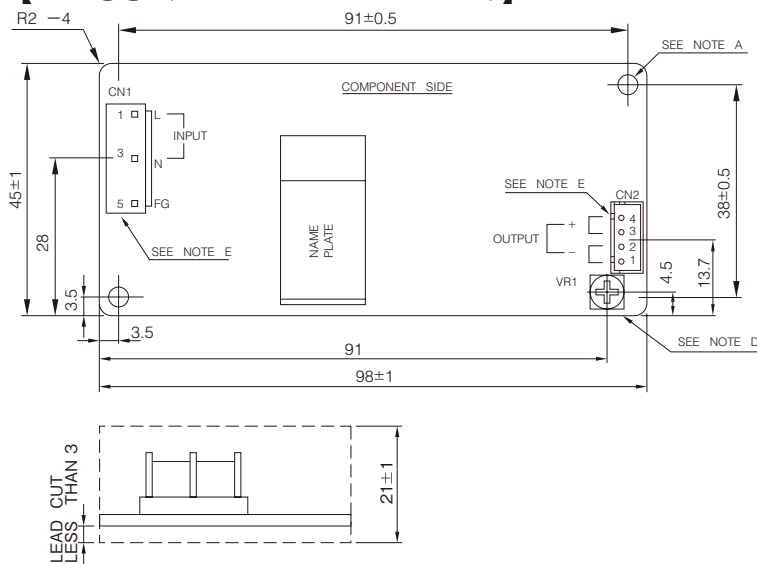

(unit : mm)

[ZWS5 (/JA : With cover)]

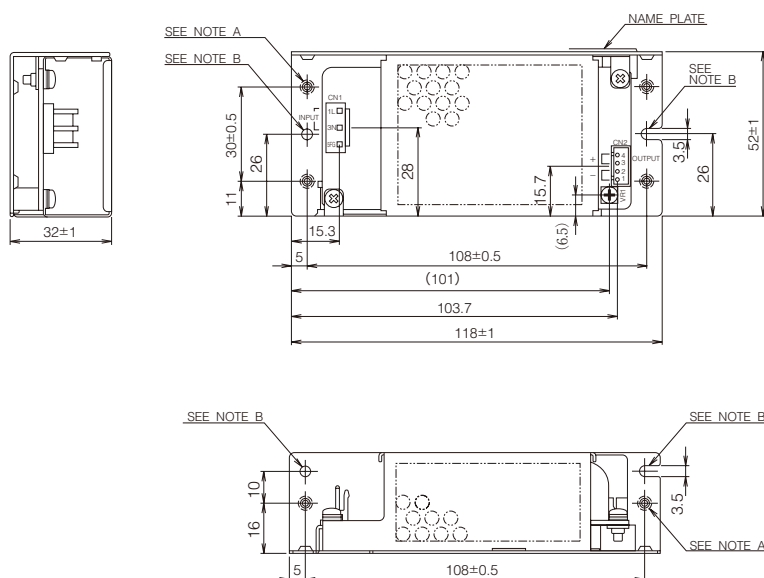

CONNECTORS USED:

PART DESCRIPTION	PART NAME	MANUFACT.	QTY
PIN HEADER (INPUT SIDE CN1)	6373-ABA (102)52	MOLEX	1
PIN HEADER (OUTPUT SIDE CN2)	6373-A04A-102	MOLEX	1

MATCHING HOUSINGS & PINS (NOT INCLUDED WITH THE PRODUCT):

SOCKET HOUSING (CN1)	7880-08B	MOLEX	1
SOCKET HOUSING (CN2)	7880-04B	MOLEX	1
TERMINAL PINS (CN1,2)	7879-2-P912	MOLEX	7

HAND CRIMPING TOOL : 11-01-0037 OR JHTR2262A MANUFACTURER : MOLEX

PCB MATERIAL
GLASS COMPOSITE : CEM-3 UL94V-0

NOTES

- A: THE 2-Φ3.5 HOLE ARE CUSTOMER CHASSIS MOUNTING HOLES. ALL MUST BE SCREWED IN ORDER TO CONFORM THE VIBRATION SPEC.
- B: MODEL NAME, MAXIMUM OUTPUT POWER, NOMINAL OUTPUT VOLTAGE, MAXIMUM OUTPUT CURRENT, MAXIMUM PEAK OUTPUT CURRENT ARE SHOWN HERE IN ACCORDANCE WITH THE SPECIFICATIONS.
- C: COUNTRY OF MANUFACTURE WILL BE SHOWN HERE.
- D: TO KEEP THE DISTANCE MORE THAN 4mm BETWEEN PC-BOARD EDGE AND CUSTOMER CHASSIS.
- E: FOR I/O TERMINAL CONNECTIONS, PLEASE USE THE RECOMMENDED CONNECTORS. MOLEX SOCKET HOUSING TERMINAL PINS ARE DIFFICULT TO PROCURE IN JAPAN. WHEN MANUFACTURING IN JAPAN, PLEASE USE "J" MODELS FOR JST CONNECTORS.

CONNECTORS USED:

PART DESCRIPTION	PART NAME	MANUFACT.	QTY
PIN HEADER (INPUT SIDE CN1)	B3P-5-VH	J.S.T.	1
PIN HEADER (OUTPUT SIDE CN2)	B4B-XH-A	J.S.T.	1

MATCHING HOUSINGS & PINS (NOT INCLUDED WITH THE PRODUCT):

SOCKET HOUSING (CN1)	VHR-5N	J.S.T.	1
SOCKET HOUSING (CN2)	XHP-4	J.S.T.	1
TERMINAL PINS (CN1)	SVH-21T-P1.1	J.S.T.	3
TERMINAL PINS (CN2)	BXH-001T-P0.6 OR SXH-001T-P0.6	J.S.T.	4

HAND CRIMPING TOOL : YC-160R CN1 MANUFACTURER: J.S.T.
: YC-110R CN2 MANUFACTURER: J.S.T.
: YRS-110 CN2 MANUFACTURER: J.S.T.

NOTES

- A: THE 2-Φ3.5 HOLE ARE CUSTOMER CHASSIS MOUNTING HOLES. ALL MUST BE SCREWED IN ORDER TO CONFORM THE VIBRATION SPEC.
- B: MODEL NAME, MAXIMUM OUTPUT POWER, NOMINAL OUTPUT VOLTAGE, MAXIMUM OUTPUT CURRENT, MAXIMUM PEAK OUTPUT CURRENT ARE SHOWN HERE IN ACCORDANCE WITH THE SPECIFICATIONS.
- C: COUNTRY OF MANUFACTURE WILL BE SHOWN HERE.
- D: TO KEEP THE DISTANCE MORE THAN 4mm BETWEEN PC-BOARD EDGE AND CUSTOMER CHASSIS.
- E: PIN-ORDER OF CONNECTORS CN1 & CN2 ARE OPPOSITE TO PIN-ORDER ON LEGEND.

CONNECTORS USED:

PART DESCRIPTION	PART NAME	MANUFACT.	QTY
PIN HEADER (INPUT SIDE CN1)	B3P-5-VH	J.S.T.	1
PIN HEADER (OUTPUT SIDE CN2)	B4B-XH-A	J.S.T.	1

MATCHING HOUSINGS & PINS (NOT INCLUDED WITH THE PRODUCT):

SOCKET HOUSING (CN1)	VHR-5N	J.S.T.	1
SOCKET HOUSING (CN2)	XHP-4	J.S.T.	1
TERMINAL PINS (CN1)	SVH-21T-P1.1	J.S.T.	3
TERMINAL PINS (CN2)	BXH-001T-P0.6 OR SXH-001T-P0.6	J.S.T.	4

HAND CRIMPING TOOL : YC-160R CN1
: YC-110R OR YRS-110 CN2
MANUFACTURER : J.S.T.

NOTES

- A: M3 EMBOSSED TAPPED & COUNTERSUNK HOLES (6) ARE FOR CUSTOMER CHASSIS MOUNTING.
- B: Φ3.5 HOLES (2) AND R1.75 SLOT HOLES (2) FOR CUSTOMER CHASSIS MOUNTING.
- C: MODEL NAME, NOMINAL OUTPUT VOLTAGE, MAXIMUM OUTPUT CURRENT, MAXIMUM PEAK OUTPUT CURRENT AND COUNTRY OF MANUFACTURE ARE SHOWN HERE IN ACCORDANCE WITH THE SPECIFICATIONS.

(unit : mm)

ZWS10 Specifications

ITEMS/UNITS		MODEL	ZWS10-3	ZWS10-5	ZWS10-12	ZWS10-15	ZWS10-24
Input	Voltage Range	(*3) V	AC85 - 265 or DC110 - 330				
	Frequency	(*3) Hz	47 - 440				
	Efficiency (typ)	(*2) %	62	70		71	
	Current (100/200VAC)(typ)	A	0.30 / 0.15				
	Inrush Current (100/200VAC)(typ)	A	15 / 30 at Ta=25°C, cold start				
Output	Nominal Voltage	VDC	3.3	5	12	15	24
	Minimum Current	A	0				
	Maximum Current	A	2		0.85	0.7	0.45
	Maximum Peak Current	(*1) A	2.4		1.02	0.84	0.54
	Maximum Power	W	6.6	10.0	10.2	10.5	10.8
	Maximum Peak Power	(*1) W	7.92	12.0	12.24	12.6	12.96
	Maximum Line Regulation	(*4)(*10) mV	20		48	60	96
	Maximum Load Regulation	(*5)(*10) mV	40		96	120	150
	Temperature Coefficient	(*6) mV	60		140	180	280
	Maximum Ripple & Noise (0 to +60°C)(*10)	mVp-p	120		150		200
	Maximum Ripple & Noise (-10 to 0°C)(*10)	mVp-p	160		180		200
	Hold-up Time (100VAC)(typ)	(*2) ms	17 at 100VAC, 10W, Ta=25°C				
	Function	Voltage Adjustable Range		+/-10%			
Over Current Protection		(*7)	>125%				
Over Voltage Protection		(*8)	>140%				
Parallel Operation			-				
Series Operation		(*9)	Possible				
Environment	Operating Temperature	(*11) °C	-10 to +50 : 100%, +60 : 70%				
	Storage Temperature	°C	-30 to +85				
	Operating Humidity	%RH	30 - 90				
	Storage Humidity	%RH	10 - 95				
	Vibration		10-55Hz (sweep 1min) less than 19.6m/s ² X, Y, Z 1h each				
	Shock		Less than 196.1m/s ²				
Isolation	Cooling		Convection cooling				
	Withstand Voltage		Input - FG : 2kVAC (20mA), Input - Output : 3kVAC (20mA), Output - FG : 500VAC (100mA) for 1min				
Standards	Isolation Resistance		More than 100MΩ at 25°C and 70%RH Output - FG 500VDC				
	Safety Standards		Approved by UL60950-1, CSA C22.2 No.60950-1, EN60950-1 Built to meet DENAN.				
Mechanical	EMI		Built to meet EN55022-B, FCC-ClassB, VCCI-B				
	Weight (typ)	g	120				
	Size (W x H x D)	mm	50 x 21 x 105				

- (*1) Operating time at peak output is less than 10 seconds. (Duty=0.35)
- (*2) At 100VAC and maximum output current, Ta=25°C.
- (*3) For cases where conformance to various safety specs (UL, CSA) are required, to be described as 100 - 240VAC, 50/60Hz on name plate.
- (*4) From 85 - 265VAC and constant load.
- (*5) From Min load - Full load (maximum power) and constant input voltage.
- (*6) From -10 to +50°C constant input voltage and load.
- (*7) Current limiting with automatic recovery.
Avoid to operate over load or dead short for 30 seconds.
- (*8) Over voltage clamping by zener diode.
- (*9) Refer to instruction manual.
- (*10) Please refer to Fig A for measurement of line & load regulation and ripple voltage.
- (*11) At standard mounting method, Fig B.

Recommended EMC Filter

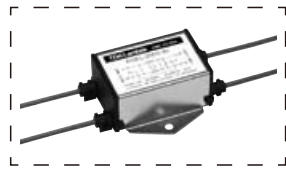

RSEL-20R5W
Please refer to "TDK-Lambda EMC Filters" catalog.

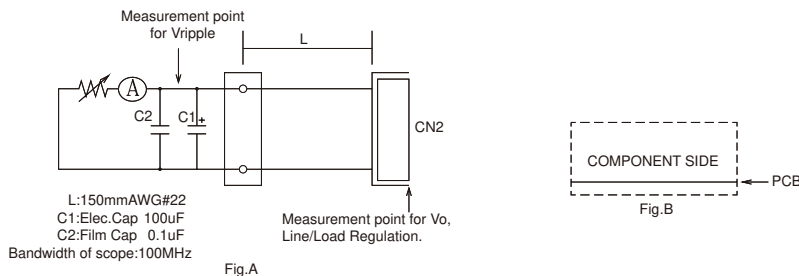

Outline Drawing

[ZWS10 (Standard : MOLEX connector)]

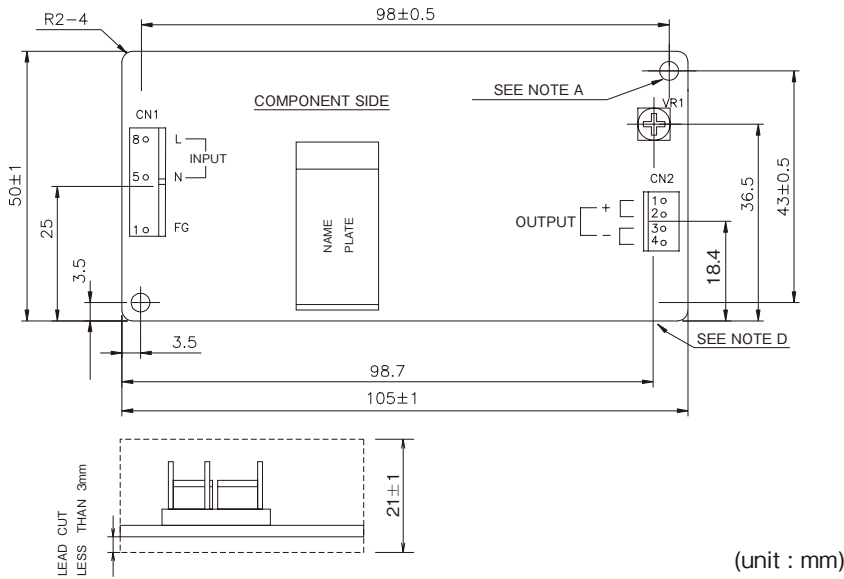

CONNECTORS USED:

PART DESCRIPTION	PART NAME	MANUFACT.	QTY
PIN HEADER (INPUT SIDE CN1)	6373-A8A (102)52	MOLEX	1
PIN HEADER (OUTPUT SIDE CN2)	6373-A04A-102	MOLEX	1

MATCHING HOUSINGS AND PINS (NOT INCLUDED WITH THE PRODUCT):

SOCKET HOUSING (CN1)	7880-08B	MOLEX	1
SOCKET HOUSING (CN2)	7880-04B	MOLEX	1
TERMINAL PINS (CN1,2)	7879-2-P912	MOLEX	7

HAND CRIMPING TOOL : 11-01-0037 OR JHTR2262A CN1, 2 MANUFACTURER : MOLEX-

PCB MATERIAL
GLASS COMPOSITE (CEM-3 UL94V-0)

NOTES

- A: THE 2- ϕ 3.5 HOLE CUSTOMER CHASSIS MOUNTING HOLES. ALL MUST BE SCREWED IN ORDER TO CONFORM THE VIBRATION SPEC.
- B: MODEL NAME, MAXIMUM OUTPUT POWER, NOMINAL OUTPUT VOLTAGE, MAXIMUM OUTPUT CURRENT, MAXIMUM PEAK OUTPUT CURRENT ARE SHOWN HERE IN ACCORDANCE WITH THE SPECIFICATIONS.
- C: COUNTRY OF MANUFACTURE WILL BE SHOWN HERE.
- D: TO KEEP THE DISTANCE MORE THAN 4mm BETWEEN PC-BOARD EDGE AND CUSTOMER'S CHASSIS.
- E: FOR I/O TERMINAL CONNECTIONS, PLEASE USE THE RECOMMENDED CONNECTORS. MOLEX SOCKET HOUSING TERMINAL PINS ARE DIFFICULT TO PROCURE IN JAPAN. WHEN MANUFACTURING IN JAPAN, PLEASE USE "J" MODELS FOR JST CONNECTORS.

[ZWS10 (/J : JST connector)]

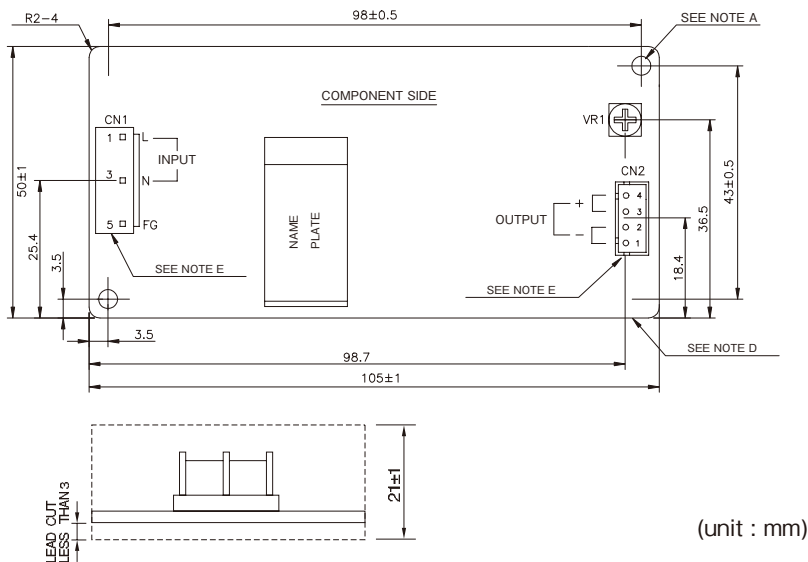

CONNECTORS USED:

PART DESCRIPTION	PART NAME	MANUFACT.	QTY
PIN HEADER (INPUT SIDE CN1)	B3P-5-VH	J.S.T.	1
PIN HEADER (OUTPUT SIDE CN2)	B4B-XH-A	J.S.T.	1

MATCHING HOUSINGS AND PINS (NOT INCLUDED WITH THE PRODUCT):

SOCKET HOUSING (CN1)	VHR-5N	J.S.T.	1
SOCKET HOUSING (CN2)	XHP-4	J.S.T.	1
TERMINAL PINS (CN1)	SVH-21T-P1.1	J.S.T.	3
TERMINAL PINS (CN2)	BXH-001T-P0.6 OR SXH-001T-P0.6	J.S.T.	4

HAND CRIMPING TOOL : YC-160R CN1 MANUFACTURER : J.S.T.
: YC-110R CN2 MANUFACTURER : J.S.T.
: YRS-110 CN2 MANUFACTURER : J.S.T.

NOTES

- A: THE 2- ϕ 3.5 HOLE ARE CUSTOMER CHASSIS MOUNTING HOLES. ALL MUST BE SCREWED IN ORDER TO CONFORM THE VIBRATION SPEC.
- B: MODEL NAME, MAXIMUM OUTPUT POWER, NOMINAL OUTPUT VOLTAGE, MAXIMUM OUTPUT CURRENT, MAXIMUM PEAK OUTPUT CURRENT ARE SHOWN HERE IN ACCORDANCE WITH THE SPECIFICATIONS.
- C: COUNTRY OF MANUFACTURE WILL BE SHOWN HERE.
- D: TO KEEP THE DISTANCE MORE THAN 4mm BETWEEN PC-BOARD EDGE AND CUSTOMER'S CHASSIS.
- E: PIN-ORDER OF CONNECTORS CN1 AND CN2 ARE OPPOSITE TO PIN-ORDER ON LEGEND.

[ZWS10 (/JA : With cover)]

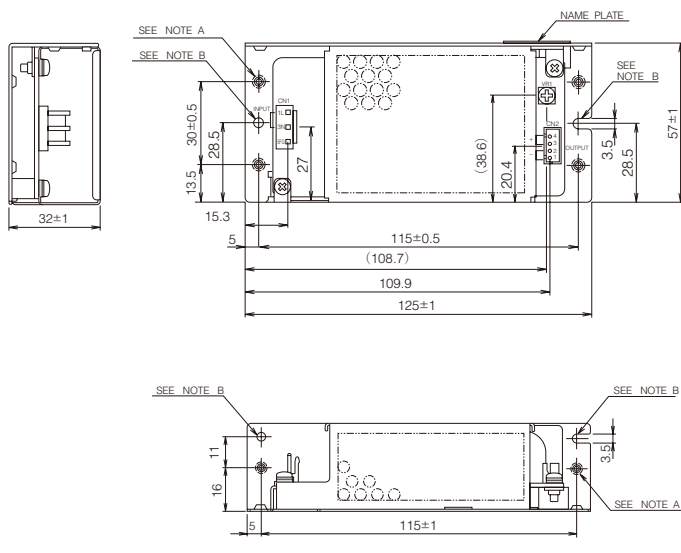

CONNECTORS USED:

PART DESCRIPTION	PART NAME	MANUFACT.	QTY
PIN HEADER (INPUT SIDE CN1)	B3P-5-VH	J.S.T.	1
PIN HEADER (OUTPUT SIDE CN2)	B4B-XH-A	J.S.T.	1

MATCHING HOUSINGS & PINS (NOT INCLUDED WITH THE PRODUCT):

SOCKET HOUSING (CN1)	VHR-5N	J.S.T.	1
SOCKET HOUSING (CN2)	XHP-4	J.S.T.	1
TERMINAL PINS (CN1)	SVH-21T-P1.1	J.S.T.	3
TERMINAL PINS (CN2)	BXH-001T-P0.6 OR SXH-001T-P0.6	J.S.T.	4

HAND CRIMPING TOOL : YC-160R CN1
: YC-110R OR YRS-110 CN2
MANUFACTURER : J.S.T.

NOTES

- A: M3 EMBOSSED TAPPED & COUNTERSUNK HOLES (6) ARE FOR CUSTOMER CHASSIS MOUNTING.
- B: ϕ 3.5 HOLES (2) AND R1.75 SLOT HOLES (2) FOR CUSTOMER CHASSIS MOUNTING.
- C: MODEL NAME, NOMINAL OUTPUT VOLTAGE, MAXIMUM OUTPUT CURRENT, MAXIMUM PEAK OUTPUT CURRENT AND COUNTRY OF MANUFACTURE ARE SHOWN HERE IN ACCORDANCE WITH THE SPECIFICATIONS.

(unit : mm)

ZWS15 Specifications

ITEMS/UNITS		MODEL	ZWS15-3	ZWS15-5	ZWS15-12	ZWS15-15	ZWS15-24
Input	Voltage Range (*3)	V	AC85 - 265 or DC110 - 330				
	Frequency (*3)	Hz	47 - 440				
	Efficiency (typ)	%	63	71			
	Current (100/200VAC)(typ)	A	0.45 / 0.23				
	Inrush Current (100/200VAC)(typ)	A	15 / 30 at, Ta=25°C, cold start				
Output	Nominal Voltage	VDC	3.3	5	12	15	24
	Minimum Current	A	0				
	Maximum Current	A	3		1.25	1	0.65
	Maximum Peak Current (*1)	A	3.6		1.5	1.2	0.78
	Maximum Power	W	9.9	15.0			
	Maximum Peak Power (*1)	W	11.88	18.0			
	Maximum Line Regulation (*4)(*10)	mV	20		48	60	96
	Maximum Load Regulation(*5)(*10)	mV	40		96	120	150
	Temperature Coefficient (*6)	mV	60		140	180	280
	Maximum Ripple & Noise (0 to +60°C)(*10)	mVp-p	120		150		
	Maximum Ripple & Noise (-10 to 0°C)(*10)	mVp-p	160		180		
	Hold-up Time (100VAC)(typ) (*2)	ms	17 at 100VAC, 15W, Ta=25°C				
	Function	Voltage Adjustable Range		±10%			
Over Current Protection (*7)			>125%				
Over Voltage Protection (*8)			>140%				
Parallel Operation			-				
Series Operation (*9)			Possible				
Environment	Operating Temperature (*11)	°C	-10 to +50 : 100%, +60 : 70%				
	Storage Temperature	°C	-30 to +85				
	Operating Humidity	%RH	30 - 90				
	Storage Humidity	%RH	10 - 95				
	Vibration		10-55Hz amplitude (sweep 1min) less than 19.6m/s² X, Y, Z 1h each				
	Shock		Less than 196.1m/s²				
	Cooling		Convection cooling				
Isolation	Withstand Voltage		Input - FG : 2kVAC (20mA), Input - Output : 3kVAC (20mA) Output - FG : 500VAC (100mA) for 1min				
	Isolation Resistance		More than 100MΩ at 25°C and 70%RH Output - FG 500VDC				
Standards	Safety Standards		Approved by UL60950-1, CSA C22.2 No.60950-1. EN60950-1. Built to meet DENAN.				
	EMI		Built to meet EN55022-B, FCC-ClassB, VCCI-B				
Mechanical	Weight (typ)	g	140				
	Size (W x H x D)	mm	50 x 21 x 125				

- (*1) Operating time at peak output is less than 10 seconds. (Duty=0.35)
- (*2) At 100VAC and maximum output current, Ta=25°C.
- (*3) For cases where conformance to various safety specs (UL, CSA) are required, to be described as 100 - 240VAC, 50/60Hz on name plate.
- (*4) From 85 - 265VAC and constant load.
- (*5) From Min load - Full load (maximum power) and constant input voltage.
- (*6) From -10 ~ +50°C constant input voltage and load.
- (*7) Current limiting with automatic recovery. Avoid to operate over load or dead short for 30 seconds.
- (*8) Over voltage clamping by zener diode.
- (*9) Refer to instruction manual.
- (*10) Please refer to Fig A for measurement of line & load regulation and ripple voltage.
- (*11) At standard mounting method, Fig B.

Recommended EMC Filter

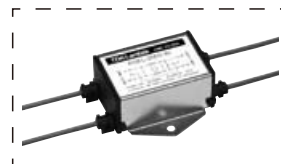

RSEL-2001W
Please refer to "TDK-Lambda EMC Filters" catalog.

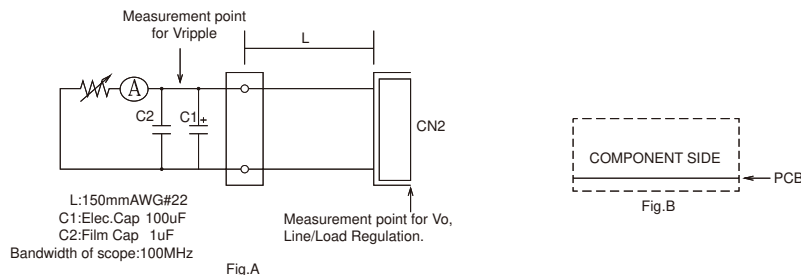

Outline Drawing

[ZWS15 (Standard : MOLEX connector)]

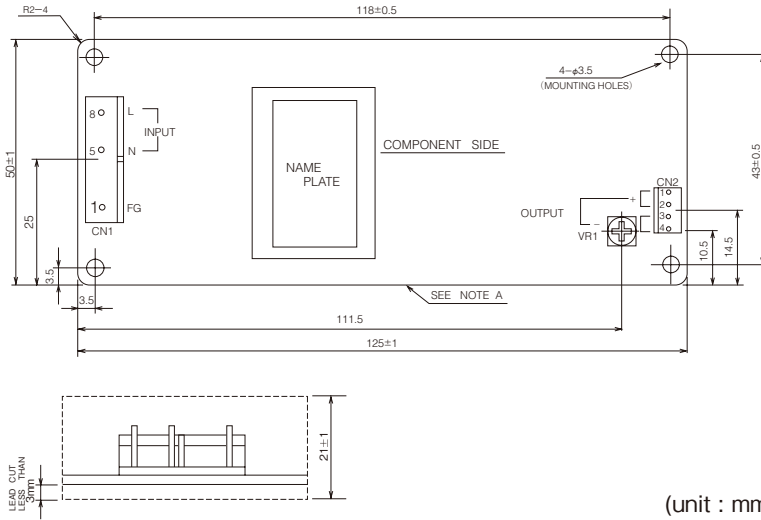

(unit : mm)

[ZWS15 (/J : JST connector)]

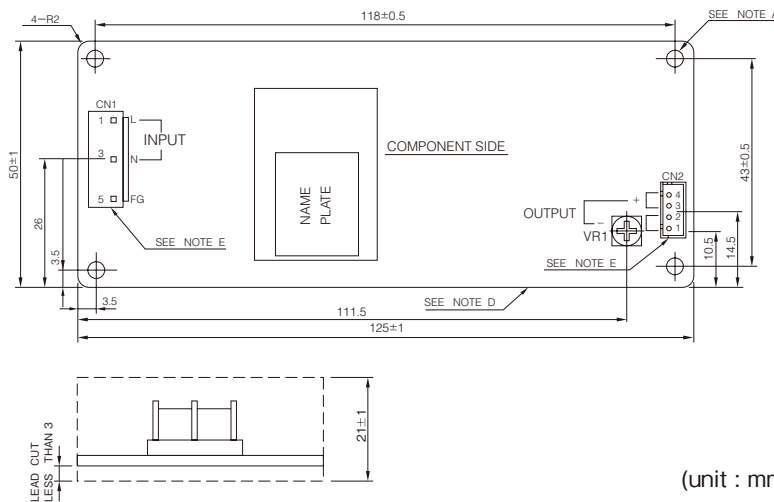

(unit : mm)

[ZWS15 (/JA : With cover)]

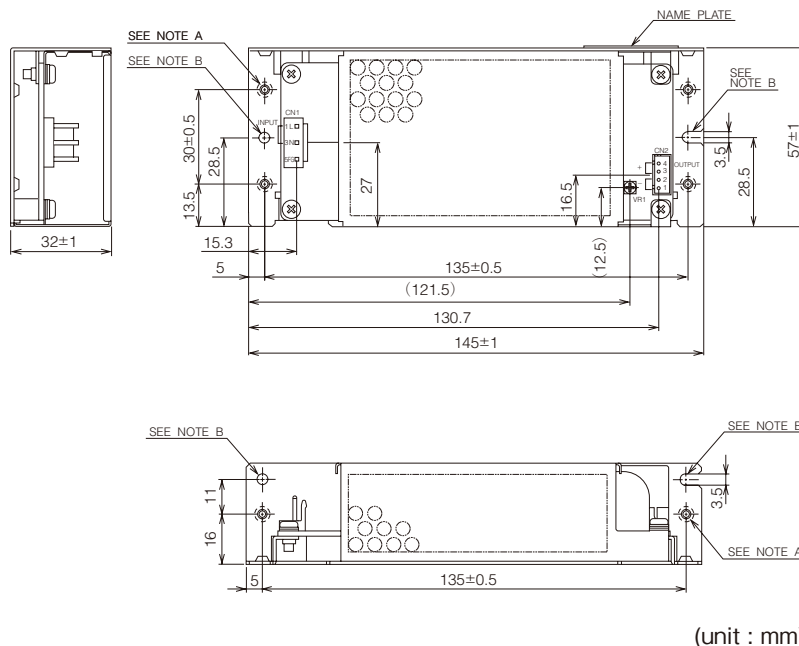

(unit : mm)

CONNECTORS USED:

PART DESCRIPTION	PART NAME	MANUFACTURER	QTY
PIN HEADER (INPUT SIDE CN1)	6373-A8A(102)52	MOLEX	1
PIN HEADER(OUTPUT SIDE CN2)	6373-A04A-102	MOLEX	1

MATCHING HOUSINGS AND PINS (NOT INCLUDED WITH THE PRODUCT):

SOCKET HOUSING (CN1)	7880-08B	MOLEX	1
SOCKET HOUSING (CN2)	7880-04B	MOLEX	1
TERMINAL PINS (CN1,CN2)	7879-2-P912	MOLEX	7

HAND CRIMPING TOOL : 11-01-0037 OR JHTR2262A CN1,2 MANUFACTURER : MOLEX

PCB MATERIAL

GLASS COMPOSITE (CEM-3 UL94V-0)

NOTES

- A: TO KEEP THE DISTANCE MORE THAN 4mm BETWEEN PCB-BOARD EDGE AND CUSTOMER'S CHASSIS.
- B: FOR I/O TERMINAL CONNECTIONS, PLEASE USE THE RECOMMENDED CONNECTORS. MOLEX SOCKET HOUSING TERMINAL PINS ARE DIFFICULT TO PROCURE IN JAPAN. WHEN MANUFACTURING IN JAPAN, PLEASE USE "J" MODELS FOR JST CONNECTORS.

CONNECTORS USED:

PART DESCRIPTION	PART NAME	MANUFACTURER	QTY
PIN HEADER (INPUT SIDE CN1)	B3P-5-VH	J.S.T.	1
PIN HEADER(OUTPUT SIDE CN2)	B4B-XH-A	J.S.T.	1

MATCHING HOUSINGS AND PINS (NOT INCLUDED WITH THE PRODUCT):

SOCKET HOUSING (CN1)	VHR-5N	J.S.T.	1
SOCKET HOUSING (CN2)	XHP-4	J.S.T.	1
TERMINAL PINS (CN1)	SVH-21T-P1.1	J.S.T.	3
TERMINAL PINS (CN2)	BXH-001T-P0.6 OR SXH-001T-P0.6	J.S.T.	4

HAND CRIMPING TOOL : YC-160R CN1 MANUFACTURER : J.S.T.

: YC-110R CN2 MANUFACTURER : J.S.T.

: YRS-110 CN2 MANUFACTURER : J.S.T.

NOTES

- A: THE 4-φ3.5 HOLE ARE CUSTOMER CHASSIS MOUNTING HOLES. ALL MUST BE SCREWED IN ORDER TO CONFORM THE VIBRATION SPEC.
- B: MODEL NAME, MAXIMUM OUTPUT POWER, NOMINAL OUTPUT VOLTAGE, MAXIMUM OUTPUT CURRENT, MAXIMUM PEAK OUTPUT CURRENT ARE SHOWN HERE IN ACCORDANCE WITH THE SPECIFICATIONS.
- C: COUNTRY OF MANUFACTURE WILL BE SHOWN HERE.
- D: TO KEEP THE DISTANCE MORE THAN 4mm BETWEEN PCB-BOARD EDGE AND CUSTOMER'S CHASSIS.
- E: PIN-ORDER OF CONNECTORS CN1 AND CN2 ARE OPPOSITE TO PIN-ORDER ON LEGEND.
- F: FOR I/O TERMINAL CONNECTIONS, PLEASE USE THE RECOMMENDED CONNECTORS.

CONNECTORS USED:

PART DESCRIPTION	PART NAME	MANUFACT.	QTY
PIN HEADER (INPUT SIDE CN1)	B3P-5-VH	J.S.T.	1
PIN HEADER (OUTPUT SIDE CN2)	B4B-XH-A	J.S.T.	1

MATCHING HOUSINGS & PINS (NOT INCLUDED WITH THE PRODUCT):

SOCKET HOUSING (CN1)	VHR-5N	J.S.T.	1
SOCKET HOUSING (CN2)	XHP-4	J.S.T.	1
TERMINAL PINS (CN1)	SVH-21T-P1.1	J.S.T.	3
TERMINAL PINS (CN2)	BXH-001T-P0.6 OR SXH-001T-P0.6	J.S.T.	4

HAND CRIMPING TOOL : YC-160R CN1

: YC-110R OR YRS-110 CN2

MANUFACTURER : J.S.T.

NOTES

- A: M3 EMBOSSED TAPPED & COUNTERSUNK HOLES (6) ARE FOR CUSTOMER CHASSIS MOUNTING.
- B: φ3.5 HOLES (2) AND R1.75 SLOT HOLES (2) FOR CUSTOMER CHASSIS MOUNTING.
- C: MODEL NAME, NOMINAL OUTPUT VOLTAGE, MAXIMUM OUTPUT CURRENT, MAXIMUM PEAK OUTPUT CURRENT AND COUNTRY OF MANUFACTURE ARE SHOWN HERE IN ACCORDANCE WITH THE SPECIFICATIONS.

ZWS30 Specifications

ITEMS/UNITS		MODEL	ZWS30-3	ZWS30-5	ZWS30-12	ZWS30-15	ZWS30-24	ZWS30-36	ZWS30-48
Input	Voltage Range (*3)	V	AC85 - 265 or DC110 - 330						
	Frequency (*3)	Hz	47 - 440						
	Efficiency (typ)	(*)2 %	70	75	77	78			
	Current (100/200VAC)(typ)	A	0.83 / 0.42						
	Inrush Current (100/200VAC)(typ)	A	15 / 30 at Ta=25°C, cold start						
Output	Nominal Voltage	VDC	3.3	5	12	15	24	36	48
	Minimum Current	A	0						
	Maximum Current	A	6		2.5	2	1.3	0.9	0.7
	Maximum Peak Current (*1)	A	7.20		3.00	2.40	1.56	1.08	0.84
	Maximum Power	W	19.8	30.0		31.2		32.4	33.6
	Maximum Peak Power (*1)	W	23.76	36.0		37.44		38.88	40.32
	Maximum Line Regulation (*4)(*)10	mV	20		48	60	96	144	192
	Maximum Load Regulation(*5)(*)10	mV	40		96	120	150	240	300
	Temperature Coefficient (*6)	mV	60		140	180	280	420	560
	Maximum Ripple & Noise (0 to +60°C)(*)10	mVp-p	120		150		200	300	400
	Maximum Ripple & Noise (-10 to 0°C)(*)10	mVp-p	160		180		200	300	400
	Hold-up Time (100VAC)(typ) (*2)	ms	17 at 100VAC, 30W, Ta=25°C						
	Function	Voltage Adjustable Range		±10%					
Over Current Protection (*7)			>125%						
Over Voltage Protection (*8)			>140%						
Parallel Operation			-						
Series Operation (*9)			Possible						
Environment	Operating Temperature (*11)	°C	-10 to +50 : 100%, +60 : 70%						
	Storage Temperature	°C	-30 to +85						
	Operating Humidity	%RH	30 - 90						
	Storage Humidity	%RH	10 - 95						
	Vibration		10-55Hz (sweep 1min) less than 19.6m/s ² X,Y,Z 1h each						
	Shock		Less than 196.1m/s ²						
Isolation	Cooling		Convection cooling						
	Withstand Voltage		Input - FG : 2kVAC (20mA), Input - Output : 3kVAC (20mA) Output - FG : 500VAC (100mA) for 1min						
Standards	Isolation Resistance		More than 100MΩ at 25°C and 70%RH Output - FG 500VDC						
	Safety Standards		Approved by UL60950-1, CSA C22.2 No.60950-1, EN60950-1 Built to meet DENAN.						
Mechanical	EMI		Built to meet EN55022-B, FCC-ClassB, VCCI-B						
	Weight (typ)	g	270						
	Size (W x H x D)	mm	55 x 26 x 133						

- (*1) Operating time at peak output is less than 10 seconds. (Duty=0.35)
- (*2) At 100VAC and maximum output current, Ta=25°C.
- (*3) For cases where conformance to various safety specs (UL, CSA) are required, to be described as 100 - 240VAC, 50/60Hz on name plate.
- (*4) From 85 - 265VAC and constant load.
- (*5) From Min load - Full load (maximum power) and constant input voltage.
- (*6) From -10 ~ +50°C constant input voltage and load.
- (*7) Current limiting with automatic recovery.
Avoid to operate over load or dead short for 30 seconds.
- (*8) Over voltage clamping by zener diode.
- (*9) Refer to instruction manual.
- (*10) Please refer to Fig A for measurement of line & load regulation and ripple voltage.
- (*11) At standard mounting method, Fig B.

● Recommended EMC Filter



RSEL-2002W
Please refer to "TDK-Lambda EMC Filters" catalog.

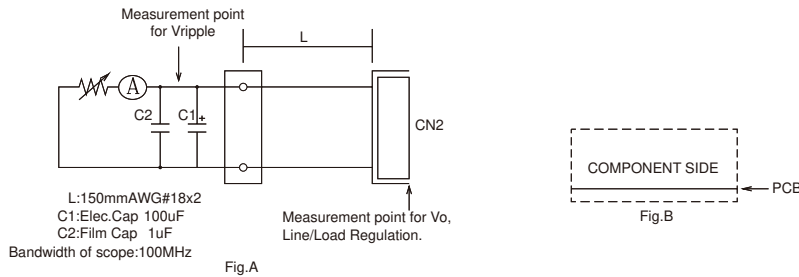

Outline Drawing

[ZWS30 (Standard : MOLEX connector)]

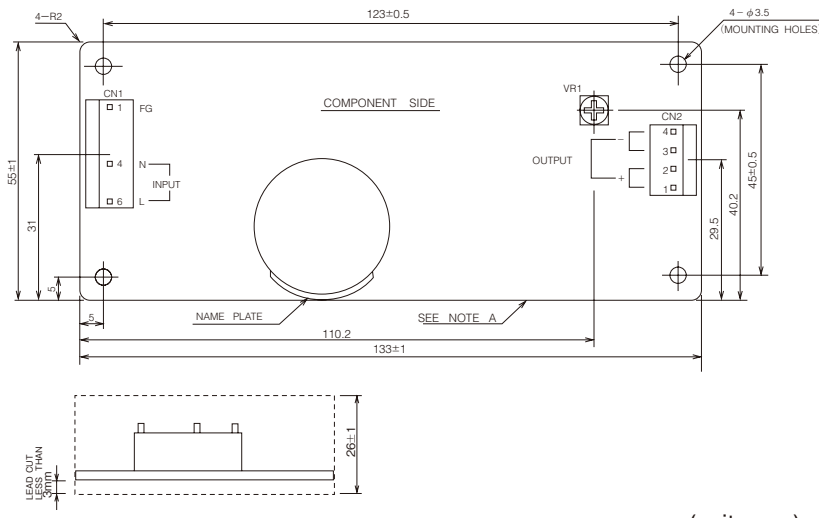

(unit : mm)

CONNECTORS USED:

PART DESCRIPTION	PART NAME	MANUFACTURER	QTY
PIN HEADER (INPUT SIDE CN1)	5414-30B	MOLEX	1
PIN HEADER (OUTPUT SIDE CN2)	5273-04A	MOLEX	1

MATCHING HOUSINGS AND PINS (NOT INCLUDED WITH THE PRODUCT):

SOCKET HOUSING (CN1)	5239-06	MOLEX	1
SOCKET HOUSING (CN2)	5239-04	MOLEX	1
TERMINAL PINS (CN1,CN2)	5167PBTL	MOLEX	7

HAND CRIMPING TOOL : JHTR2445A CN1,2 MANUFACTURER : MOLEX

PCB MATERIAL
GLASS COMPOSITE (CEM-3 UL94V-0)

NOTES

- A: TO KEEP THE DISTANCE MORE THAN 4mm BETWEEN PC-BOARD EDGE AND CUSTOMER'S CHASSIS.
- B: FOR I/O TERMINAL CONNECTIONS, PLEASE USE THE RECOMMENDED CONNECTORS. MOLEX SOCKET HOUSING TERMINAL PINS ARE DIFFICULT TO PROCURE IN JAPAN. WHEN MANUFACTURING IN JAPAN, PLEASE USE "J" MODELS FOR JST CONNECTORS.

[ZWS30 (/J : JST connector)]

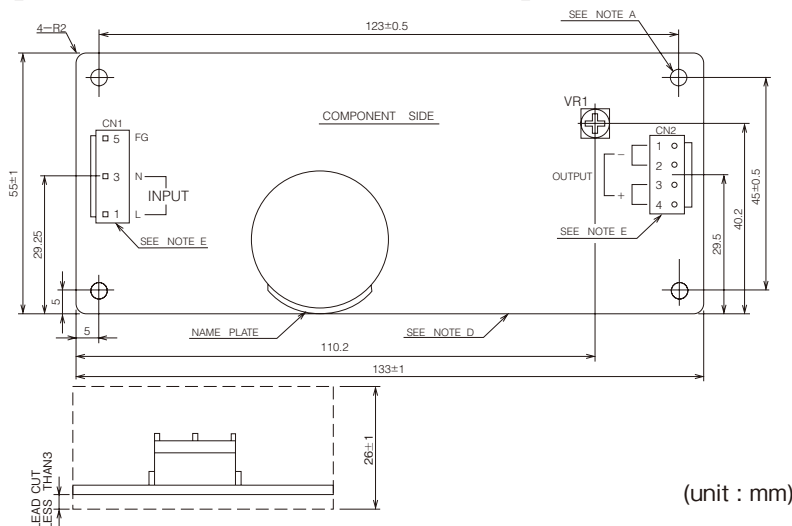

(unit : mm)

CONNECTORS USED:

PART DESCRIPTION	PART NAME	MANUFACTURER	QTY
PIN HEADER (INPUT SIDE CN1)	B3P-5-VH	J.S.T.	1
PIN HEADER (OUTPUT SIDE CN2)	B4P-VH	J.S.T.	1

MATCHING HOUSING AND PINS (NOT INCLUDED WITH THE PRODUCT):

SOCKET HOUSING (CN1)	VHR-5N	J.S.T.	1
SOCKET HOUSING (CN2)	VHR-4N	J.S.T.	1
TERMINAL PINS (CN1,CN2)	SVH-21T-P1.1	J.S.T.	7

HAND CRIMPING TOOL : YC-160R CN1,2 MANUFACTURER : J.S.T.

NOTES

- A: THE 4-φ3.5 HOLES ARE CUSTOMER CHASSIS MOUNTING HOLES. ALL MUST BE SCREWED IN ORDER CONFORM THE VIBRATION SPEC.
- B: MODEL NAME, MAXIMUM OUTPUT POWER, NOMINAL OUTPUT VOLTAGE, MAXIMUM OUTPUT CURRENT, MAXIMUM PEAK OUTPUT CURRENT ARE SHOWN HERE IN ACCORDANCE WITH THE SPECIFICATIONS.
- C: COUNTRY OF MANUFACTURE WILL BE SHOWN HERE.
- D: TO KEEP THE DISTANCE MORE THAN 4mm BETWEEN PC-BOARD EDGE AND CUSTOMER'S CHASSIS.
- E: PIN-ORDER OF CONNECTORS CN1 AND CN2 ARE OPPOSITE TO PIN-ORDER ON LEGEND.
- F: FOR I/O TERMINAL CONNECTIONS, PLEASE USE THE RECOMMENDED CONNECTORS.

[ZWS30 (/JA : With cover)]

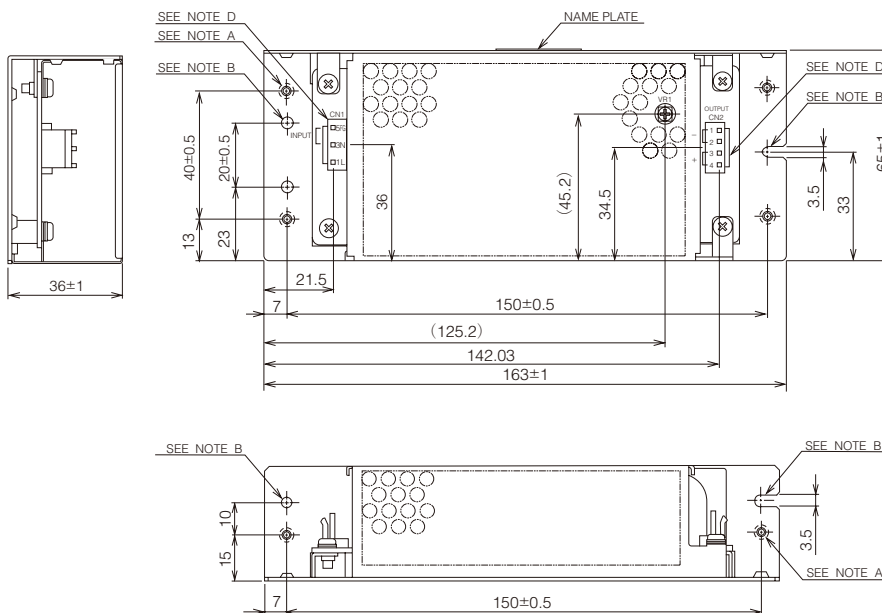

(unit : mm)

CONNECTORS USED:

PART DESCRIPTION	PART NAME	MANUFACT.	QTY
PIN HEADER (INPUT SIDE CN1)	B3P-5-VH	J.S.T.	1
PIN HEADER (OUTPUT SIDE CN2)	B4P-VH	J.S.T.	1

MATCHING HOUSINGS & PINS (NOT INCLUDED WITH THE PRODUCT):

SOCKET HOUSING (CN1)	VHR-5N	J.S.T.	1
SOCKET HOUSING (CN2)	VHR-4N	J.S.T.	1
TERMINAL PINS (CN1,2)	SVH-21T-P1.1	J.S.T.	7

HAND CRIMPING TOOL : YC-160R CN1,2 MANUFACTURER : J.S.T.

NOTES

- A: M3 EMBOSSED TAPPED & COUNTERSUNK HOLES (6) ARE FOR CUSTOMER CHASSIS MOUNTING.
- B: φ3.5 HOLES (3) AND R1.75 SLOT HOLES (2) FOR CUSTOMER CHASSIS MOUNTING.
- C: MODEL NAME, NOMINAL OUTPUT VOLTAGE, MAXIMUM OUTPUT CURRENT, MAXIMUM PEAK OUTPUT CURRENT AND COUNTRY OF MANUFACTURE ARE SHOWN HERE IN ACCORDANCE WITH THE SPECIFICATIONS.
- D: PIN-ORDER OF CONNECTORS CN1 & CN2 ARE OPPOSITE TO PIN-ORDER ON LEGEND.

ZWS50 Specifications

ITEMS/UNITS		MODEL	ZWS50-3	ZWS50-5	ZWS 50-12	ZWS 50-15	ZWS50-24	ZWS50-36	ZWS50-48
Input	Voltage Range (*3)	V	AC85 - 265 or DC110 - 330						
	Frequency (*3)	Hz	47 - 440						
	Efficiency (typ)	%	73	77	80	81	82		
	Current (100/200VAC)(typ)	A	1.4 / 0.7						
	Inrush Current (100/200VAC)(typ)	A	15 / 30 at, Ta=25°C, cold start						
Output	Nominal Voltage	VDC	3.3	5	12	15	24	36	48
	Minimum Current	A	0						
	Maximum Current	A	10		4.3	3.5	2.1	1.4	1.1
	Maximum Peak Current (*1)	A	12.0		5.16	4.20	2.52	1.68	1.32
	Maximum Power	W	33.0	50.0	51.6	52.5	50.4		52.8
	Maximum Peak Power (*1)	W	39.60	60.00	61.92	63.00	60.48		63.36
	Maximum Line Regulation (*4)(*10)	mV	20		48	60	96	144	192
	Maximum Load Regulation(*5)(*10)	mV	40		96	120	150	240	300
	Temperature Coefficient (*6)	mV	60		140	180	280	420	560
	Maximum Ripple & Noise (0 to +60°C)(*10)	mVp-p	120		150		200	300	400
	Maximum Ripple & Noise (-10 to 0°C)(*10)	mVp-p	160		180		200	300	400
	Hold-up Time (100VAC)(typ) (*2)	ms	17 at 100VAC, 50W, Ta=25°C						
	Function	Voltage Adjustable Range		±10%					
Over Current Protection (*7)			>125%						
Over Voltage Protection (*8)			115% - 135%						
Parallel Operation			-						
Series Operation (*9)			Possible						
Environment		Operating Temperature (*11)	°C	-10 to +50 : 100%, +60 : 70%					
	Storage Temperature	°C	-30 to +85						
	Operating Humidity	%RH	30 - 90						
	Storage Humidity	%RH	10 - 95						
	Vibration		10-55Hz (sweep 1min) less than 19.6m/s ² X,Y,Z 1h each						
	Shock		Less than 196.1m/s ²						
	Cooling		Convection cooling						
Isolation	Withstand Voltage		Input - FG : 2kVAC (20mA), Input - Output : 3kVAC (20mA) Output - FG : 500VAC (100mA) for 1min						
	Isolation Resistance		More than 100MΩ at 25°C and 70%RH Output - FG 500VDC						
Standards	Safety Standards		Approved by UL60950-1, CSA C22.2 No 60950-1, EN60950-1. Built to meet DENAN.						
	EMI		Built to meet EN55022-B, FCC-ClassB, VCCI-B						
Mechanical	Weight (typ)	g	360						
	Size (W x H x D)	mm	55 x 26 x 195						

(*1) Operating time at peak output is less than 10 seconds. (Duty=0.35)

(*2) At 100VAC and maximum output current, Ta=25°C.

(*3) For cases where conformance to various safety specs (UL, CSA) are required, to be described as 100 - 240VAC, 50/60Hz on name plate.

(*4) From 85 - 265VAC and constant load.

(*5) From Min load - Full load (maximum power) and constant input voltage.

(*6) From -10 to +50°C constant input voltage and load.

(*7) Current limiting with automatic recovery.

Avoid to operate over load or dead short for 30 seconds.

(*8) OVP circuit will shutdown output, manual reset.

(*9) Refer to instruction manual.

(*10) Please refer to Fig A for measurement of line & load regulation and ripple voltage.

(*11) At standard mounting method, Fig B.

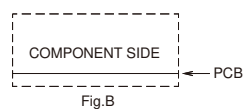
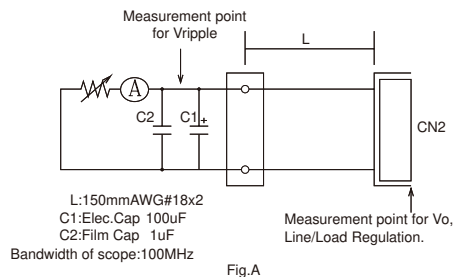

Recommended EMC Filter

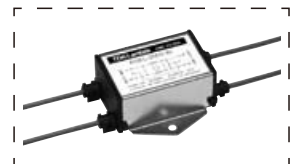

RSEL-2002W

Please refer to "TDK-Lambda EMC Filters" catalog.

Outline Drawing

[ZWS50 (Standard : MOLEX connector)]

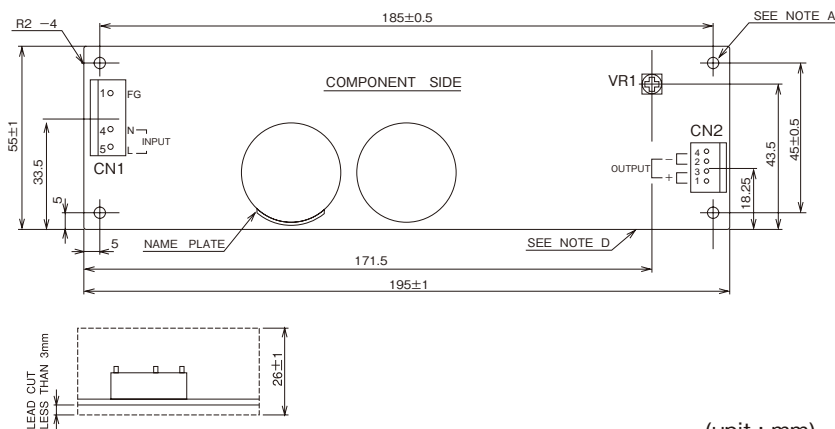

(unit : mm)

CONNECTORS USED:

PART DESCRIPTION	PART NAME	MANUFACTURER	QTY
PIN HEADER (INPUT SIDE CN1)	5414-30B	MOLEX	1
PIN HEADER (OUTPUT SIDE CN2)	5273-04A	MOLEX	1

MATCHING HOUSINGS AND PINS (NOT INCLUDED WITH THE PRODUCT):

SOCKET HOUSING (CN1)	5239-06	MOLEX	1
SOCKET HOUSING (CN2)	5239-04	MOLEX	1
TERMINAL PINS (CN1, CN2)	5167PBTL	MOLEX	7

HAND CRIMPING TOOL : JHTR2445A CN1,2 MANUFACTURER : MOLEX

PCB MATERIAL
GLASS COMPOSITE (CEM-3 UL94V-0)

NOTES

- A: THE 4-Φ3.5 HOLES ARE CUSTOMER CHASSIS MOUNTING HOLES. ALL MUST BE SCREWED IN ORDER TO CONFORM THE VIBRATION SPEC.
- B: MODEL NAME, MAXIMUM OUTPUT POWER, NOMINAL OUTPUT VOLTAGE, MAXIMUM OUTPUT CURRENT, MAXIMUM PEAK OUTPUT CURRENT ARE SHOWN HERE IN ACCORDANCE WITH THE SPECIFICATIONS.
- C: COUNTRY OF MANUFACTURE WILL BE SHOWN HERE.
- D: TO KEEP THE DISTANCE MORE THAN 4mm BETWEEN PCB-BOARD EDGE AND CUSTOMER'S CHASSIS.
- E: C-UL-US, TUV and CE Marking (Only 3V,5V,12V,15V,24V,36V,48V)
- F: FOR I/O TERMINAL CONNECTIONS, PLEASE USE THE RECOMMENDED CONNECTORS. MOLEX SOCKET HOUSING TERMINAL PINS ARE DIFFICULT TO PROCURE IN JAPAN. WHEN MANUFACTURING IN JAPAN, PLEASE USE "J" MODELS FOR JST CONNECTORS.

[ZWS50 (/J : JST connector)]

PCB MATERIAL
GLASS COMPOSITE (CEM-3 UL94V-0)

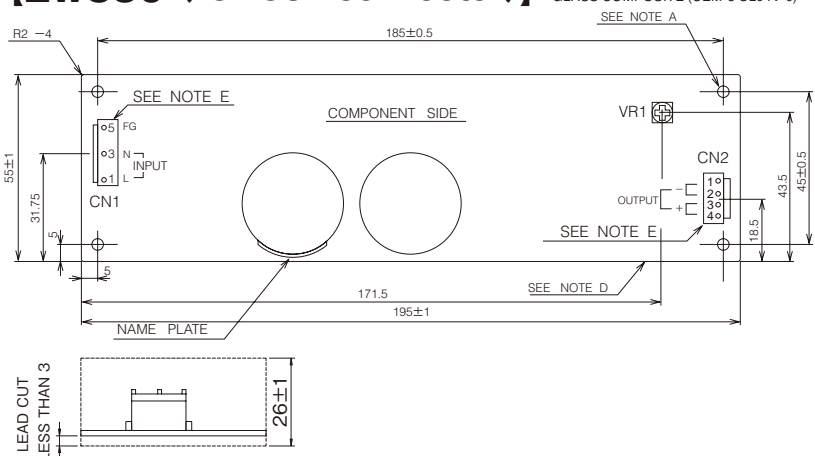

(unit : mm)

CONNECTORS USED:

PART DESCRIPTION	PART NAME	MANUFACTURER	QTY
PIN HEADER (INPUT SIDE CN1)	B3P-5-VH	J.S.T.	1
PIN HEADER (OUTPUT SIDE CN2)	B4P-VH	J.S.T.	1

MATCHING HOUSINGS AND PINS (NOT INCLUDED WITH THE PRODUCT):

SOCKET HOUSING (CN1)	VHR-5N	J.S.T.	1
SOCKET HOUSING (CN2)	VHR-4N	J.S.T.	1
TERMINAL PINS (CN1, CN2)	SVH-21T-P1.1	J.S.T.	7

HAND CRIMPING TOOL : YC-160R CN1, 2 MANUFACTURER : J.S.T.

PCB MATERIAL
GLASS COMPOSITE (CEM-3 UL94V-0)

NOTES

- A: THE 4-Φ3.5 HOLE ARE CUSTOMER CHASSIS MOUNTING HOLES. ALL MUST BE SCREWED IN ORDER TO CONFORM THE VIBRATION SPEC.
- B: MODEL NAME, MAXIMUM OUTPUT POWER, NOMINAL OUTPUT VOLTAGE, MAXIMUM OUTPUT CURRENT, MAXIMUM PEAK OUTPUT CURRENT ARE SHOWN HERE IN ACCORDANCE WITH THE SPECIFICATIONS.
- C: COUNTRY OF MANUFACTURE WILL BE SHOWN HERE.
- D: TO KEEP THE DISTANCE MORE THAN 4mm BETWEEN PCB-BOARD EDGE AND CUSTOMER'S CHASSIS.
- E: PIN-ORDER OF CONNECTORS CN1 AND CN2 ARE OPPOSITE TO PIN-ORDER ON LEGEND.
- F: FOR I/O TERMINAL CONNECTIONS, PLEASE USE THE RECOMMENDED CONNECTORS.

[ZWS50 (/JA : With cover)]

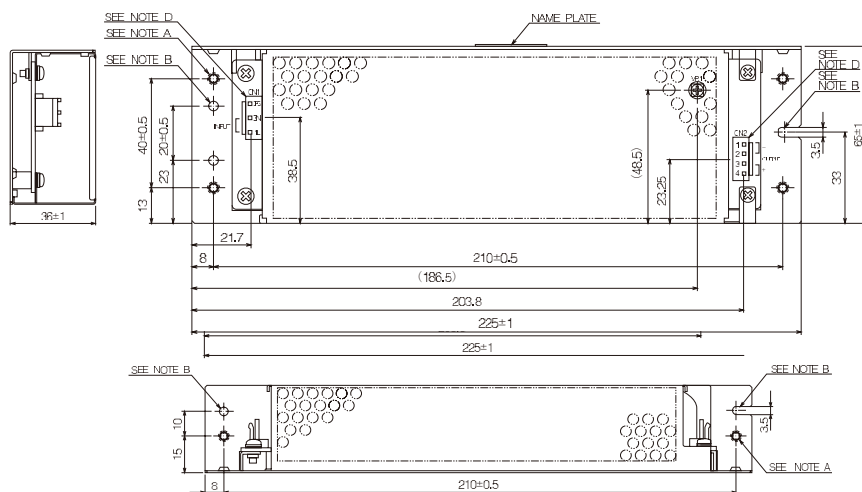

(unit : mm)

CONNECTORS USED:

PART DESCRIPTION	PART NAME	MANUFACTURER	QTY
PIN HEADER (INPUT SIDE CN1)	B3P-5-VH	J.S.T.	1
PIN HEADER (OUTPUT SIDE CN2)	B4P-VH	J.S.T.	1

MATCHING HOUSINGS AND PINS (NOT INCLUDED WITH THE PRODUCT):

SOCKET HOUSING (CN1)	VHR-5N	J.S.T.	1
SOCKET HOUSING (CN2)	VHR-4N	J.S.T.	1
TERMINAL PINS (CN1, CN2)	SVH-21T-P1.1	J.S.T.	7

HAND CRIMPING TOOL : YC-160R CN1, 2
MANUFACTURER : J.S.T.

NOTES

- A: M3 EMBOSSED TAPPED & COUNTERSUNK HOLES (6) ARE FOR CUSTOMER CHASSIS MOUNTING.
- B: Φ3.5 HOLES (3) AND R1.75 SLOT HOLES (2) FOR CUSTOMER CHASSIS MOUNTING.
- C: MODEL NAME, NOMINAL OUTPUT VOLTAGE, MAXIMUM OUTPUT CURRENT, MAXIMUM PEAK OUTPUT CURRENT AND COUNTRY OF MANUFACTURE ARE SHOWN HERE IN ACCORDANCE WITH THE SPECIFICATIONS.
- D: PIN-ORDER OF CONNECTORS CN1 & CN2 ARE OPPOSITE TO PIN-ORDER ON LEGEND.

ZWS

ZWS50AF Specifications

ITEMS/UNITS		MODEL	ZWS50AF-3	ZWS50AF-5	ZWS50AF-12	ZWS50AF-15	ZWS50AF-24
Input	Voltage Range (*3)	V	AC85 - 265 or DC120 - 370				
	Frequency (*3)	Hz	47-63				
	Power Factor (100/200VAC)(typ)(*2)		0.99 / 0.95				
	Efficiency (typ) (*2)	%	67	75	78	79	81
	Current (100/200VAC)(typ) (*2)	A	0.6 / 0.3				
	Inrush Current (100/200VAC)(typ)(*4)	A	14 / 28 at Ta=25°C, cold start				
	Leakage Current (*11)	mA	0.5 MAX, 0.1 (typ) at 100VAC / 0.16 (typ) at 230VAC				
Output	Nominal Voltage	V	3.3	5	12	15	24
	Maximum Current	A	10	10	4.3	3.5	2.1
	Maximum Peak Current (*1)	A	-				
	Maximum Power	W	33	50	51.6	52.5	50.4
	Maximum Peak Power (*1)	W	-				
	Maximum Line Regulation (*5)(*6)	mV	20	20	48	60	96
	Maximum Load Regulation (*5)(*7)	mV	40	40	96	120	150
	Temperature Coefficient		Less than 0.02%/°C				
	Maximum Ripple & Noise (0≤Ta≤60°C)(*5)	mVp-p	120	120	150		
	Maximum Ripple & Noise (-10≤Ta<0°C)(*5)	mVp-p	160	160	180		
	Hold-up Time (typ) (*10)	ms	20				
	Function	Voltage Adjustable Range	VDC	2.97 - 3.63	4.5 - 5.5	10.8 - 13.2	13.5 - 16.5
Over Current Protection (*8)		A	>10.5	>10.5	>5.4	>4.4	>2.7
Over Voltage Protection (*9)		VDC	3.79 - 4.95	5.75 - 7.00	13.8 - 16.2	17.3 - 20.3	27.6 - 32.4
Remote ON/OFF Control			Possible				
Parallel Operation			-				
Series Operation			Possible				
Environment	Operating Temperature (*12)	°C	-10 to 60 Convection : -10 to 50: 100%, +60: 70%				
	Storage Temperature	°C	-30 to +85				
	Operating Humidity	%RH	30 - 90 (No dewdrop)				
	Storage Humidity	%RH	10 - 95 (No dewdrop)				
	Vibration		At no operating, 10-55Hz (sweep for 1min) 19.6m/s² constant, X, Y, Z 1hour each.				
	Shock (In package)		Less than 196.1m/s²				
	Cooling		Convection cooling				
Isolation	Withstand Voltage		Input - FG : 2kVAC (20mA), Input - Output : 3kVAC (20mA) Output - FG : 500VAC (100mA) for 1min				
	Isolation Resistance		More than 100MΩ at 25°C and 70%RH Output - FG : 500VDC				
Standards	Safety Standards (*13)		Approved by UL60950-1, CSA C22.2 No.60950-1, EN60950-1. Built to meet DENAN.				
	PFHC		Built to meet EN61000-3-2				
	EMI		Built to meet EN55011/EN55022-B, FCC-ClassB, VCCI-B.				
	Immunity		Built to meet EN61000-4-2, -3, -4, -5, -6, -8, -11				
Mechanical	Weight (typ)	g	210				
	Size (W x H x D)	mm	55 x 26 x 195 (Refer to outline drawing)				

- (*1) Operating period at peak output current is less than 10 sec. (Average output power and current is less than maximum output power and current)
- (*2) At 100/200VAC, Ta=25°C and maximum output power.
- (*3) For cases where conformance to various safety specs (UL, CSA, EN) are required, to be described as 100-240VAC (50/60Hz).
- (*4) Not applicable for the in-rush current to noise filter for less than 0.2ms.
- (*5) Please refer to Fig. A for measurement of line & load regulation and ripple voltage. (Measure with JEITA RC-9131 probe.)
- (*6) 85 - 265VAC, constant load.
- (*7) No load-maximum load, constant input voltage.

- (*8) Constant current limit with automatic recovery. Not operate at overload or dead short condition for more than 30 seconds.
- (*9) OVP circuit will shut down output, manual reset. (Line recycle)
- (*10) At 100/200VAC nominal output voltage and maximum output current.
- (*11) Measured by the each measuring method of UL, CSA, EN and DENAN (at 60Hz).
- (*12) At standard mounting.
 - Load (%) is percent of maximum output power or maximum output current, whichever is greater.
 - For other mountings, refer to derating curve.
 - When forced air cooling, refer to derating curve.
- (*13) As for DENAN, built to meet at 100VAC.

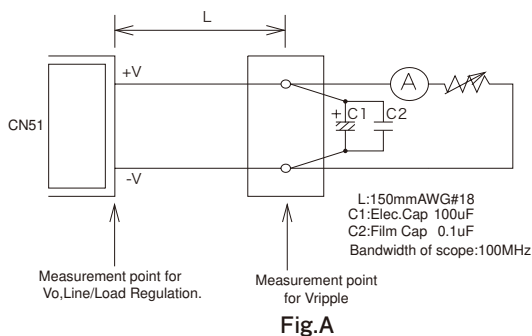

Recommended EMC Filter

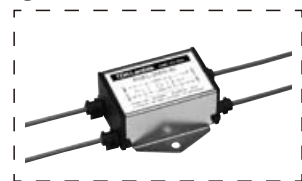

RSEL-2002W
Please refer to "TDK-Lambda EMC Filters" catalog.

Outline Drawing

[ZWS50AF (/J : JST connector)]

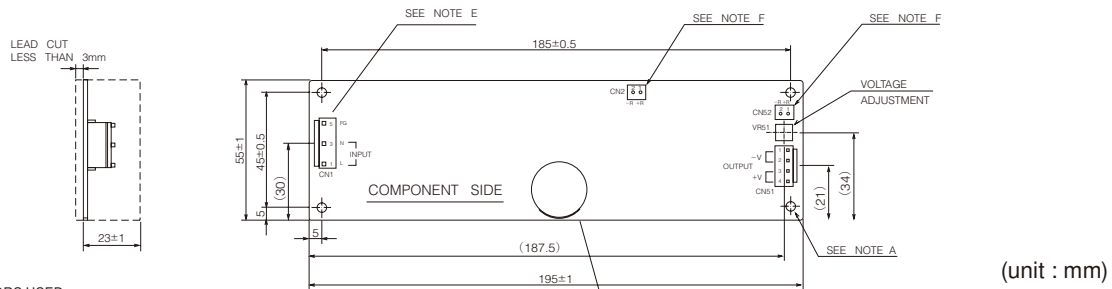

CONNECTORS USED:

PART DESCRIPTION	PART NAME	MANUFACT.	QTY
PIN HEADER (INPUT SIDE CN1)	B3P-5-VH	J.S.T	1
PIN HEADER (OUTPUT SIDE CN51)	B4P-VH	J.S.T	1

*OUTPUT CURRENT OF EACH CONNECTOR PIN MUST BE LESS THAN 5A.

MATCHING HOUSINGS & PINS (NOT INCLUDED WITH THE PRODUCT):

SOCKET HOUSING (CN1)	VHR-5N	J.S.T	1
SOCKET HOUSING (CN51)	VHR-4N	J.S.T	1
TERMINAL PINS (CN1,51)	SVH-21T-P1.1	J.S.T	7

HAND CRIMPING TOOL : YC-160R MANUFACTURER : J.S.T.

PCB MATERIAL
GLASS COMPOSITE (CEM-3 UL94V-0)

※I/O connectors: MOLEX is also available.

NOTES

- A: THE 4-φ3.5 HOLES ARE FOR CUSTOMER'S CHASSIS MOUNTING HOLES. ALL MUST BE SCREWED IN ORDER TO CONFORM THE VIBRATION SPEC.
- B: MODEL NAME, INPUT VOLTAGE RANGE, NOMINAL OUTPUT VOLTAGE, MAXIMUM OUTPUT CURRENT ARE SHOWN HERE IN ACCORDANCE WITH THE SPECIFICATIONS.
- C: COUNTRY OF MANUFACTURE WILL BE SHOWN HERE.
- D: TO KEEP THE DISTANCE MORE THAN 4mm BETWEEN PCB EDGE AND CUSTOMER'S CHASSIS.
- E: FG IS FOR SAFETY GROUND CONNECTION.
- F: REMOTE ON/OFF CONTROL CONNECTOR (CN2,CN52) : B2B-XH-AM (J.S.T.) *CN2 IS NORMALLY SHORTED BY JM-2W-96(J.S.T.)
- MATCHING HOUSING : XHP-2 (J.S.T.)
- MATHING TERMINAL : BXH-001T-P0.6 (J.S.T.) OR SXH-001T-P0.6 (J.S.T.)
- HAND CRIMPING TOOL : YC-110R OR YRS-110 MANUFACTURER : J.S.T.
- G: PIN-ORDER OF CONNECTORS CN1 & CN51 ARE OPPOSITE TO PIN-ORDER ON LEGEND.
- H: FOR I/O TERMINAL CONNECTIONS, PLEASE USE THE RECOMMENDED CONNECTORS.

[ZWS50AF (/JA : With cover)]

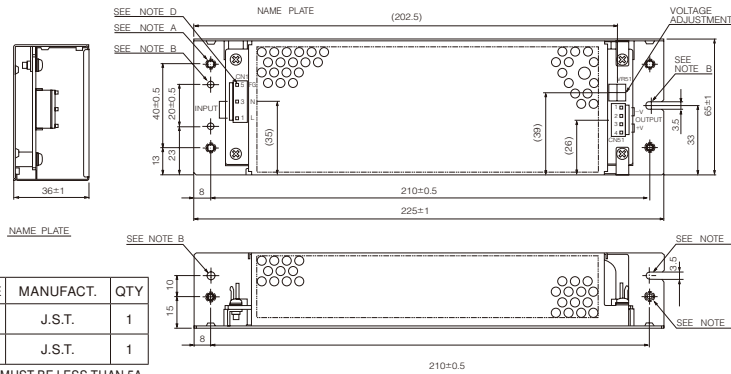

CONNECTORS USED:

PART DESCRIPTION	PART NAME	MANUFACT.	QTY
PIN HEADER (INPUT SIDE CN1)	B3P-5-VH	J.S.T.	1
PIN HEADER (OUTPUT SIDE CN2)	B4P-VH	J.S.T.	1

*OUTPUT CURRENT OF EACH CONNECTOR PIN MUST BE LESS THAN 5A.

MATCHING HOUSINGS & PINS (NOT INCLUDED WITH THE PRODUCT):

SOCKET HOUSING (CN1)	VHR-5N	J.S.T.	1
SOCKET HOUSING (CN2)	VHR-4N	J.S.T.	1
TERMINAL PINS (CN1,2)	SVH-21T-P1.1	J.S.T.	7

HAND CRIMPING TOOL : YC-160R MANUFACTURER : J.S.T.

NOTES

- A: M3 EMBOSSED TAPPED & COUNTERSUNK HOLES (6) ARE FOR CUSTOMER CHASSIS MOUNTING.
- B: φ3.5 HOLES (3) AND R1.75 SLOT HOLES (2) FOR CUSTOMER CHASSIS MOUNTING.
- C: MODEL NAME, NOMINAL OUTPUT VOLTAGE, MAXIMUM OUTPUT CURRENT AND COUNTRY OF MANUFACTURE ARE SHOWN HERE IN ACCORDANCE WITH THE SPECIFICATIONS.
- D: FG IS FOR SAFETY GROUND CONNECTION.
- E: PIN-ORDER OF CONNECTORS CN1 & CN51 ARE OPPOSITE TO PIN-ORDER ON LEGEND.

(unit : mm)

Output Derating

Convection Cooling

Output Derating Curve (Without cover)

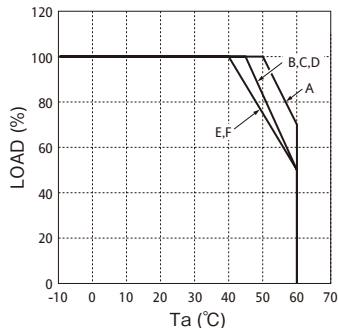

Convection Cooling

Output Derating Curve (With cover)

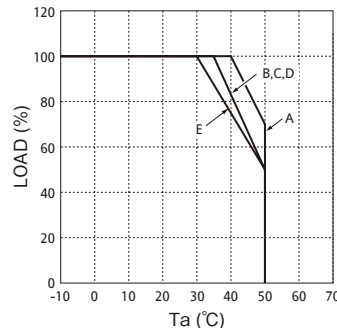

Forced Air Cooling

Output Derating Curve

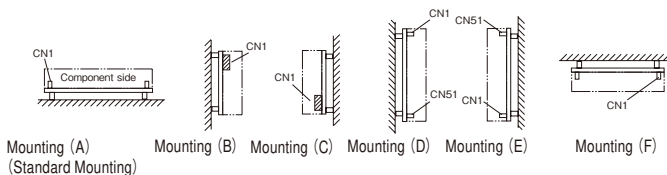
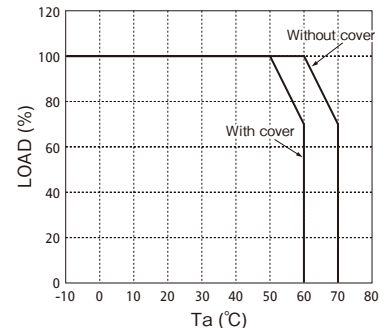

Recommended standard mounting method is (A).

The output derating may vary due to mounting method and ambient temperature. Please use within the range of derating above.

In the derating curve, maximum output current or maximum output power in specification refers 100%.

*Please do not use (F) with cover.

Recommended Minimum Air Velocity : 0.7m/s (Measured at component side of PCB, Air must flow through component side.)

As a reference for forced air cooling, let air flow so that the temperature of electrolytic capacitor C6 is lower than 85°C.

ZWS75AF Specifications

ITEMS/UNITS		MODEL	ZWS75AF-3	ZWS75AF-5	ZWS75AF-12	ZWS75AF-15	ZWS75AF-24	ZWS75AF-36	ZWS75AF-48
Input	Voltage Range (*3)	V	AC85 - 265 or DC120 - 370						
	Frequency (*3)	Hz	47-63						
	Power Factor (100/200VAC)(typ) (*2)		0.99 / 0.95						
	Efficiency (typ) (*2)	%	67	75	78	79	82		
	Current (100/200VAC)(typ) (*2)	A	0.8 / 0.4		1.2 / 0.6				
	Inrush Current (100/200VAC)(typ) (*4)	A	14 / 28 at, Ta=25°C, cold start						
	Leakage Current (*11)	mA	0.5 MAX, 0.1 (typ) at 100VAC / 0.16 (typ) at 230VAC						
Output	Nominal Voltage	VDC	3.3	5	12	15	24	36	48
	Maximum Current	A	15		6.3	5	3.2	2.1	1.6
	Maximum Peak Current (*1)	A	-		7.5	6	3.8	2.5	1.9
	Maximum Power	W	49.5	75	75.6	75	76.8	75.6	76.8
	Maximum Peak Power (*1)	W	-		90		91.2	90	91.2
	Maximum Line Regulation (*5)(*6)	mV	20		48	60	96	144	192
	Maximum Line Regulation (*5)(*7)	mV	40		96	120	150	200	240
	Temperature Coefficient		Less than 0.02%/°C						
	Maximum Ripple & Noise (0≤Ta≤60°C) (*5)	mVp-p	120		150			200	
	Maximum Ripple & Noise (-10≤Ta<0°C) (*5)	mVp-p	160		180			240	
	Hold-up Time (typ) (*10)	ms	20						
Function	Voltage Adjustable Range	VDC	2.85 - 3.63	4.5 - 5.5	10.8 - 13.2	13.5 - 16.5	21.6 - 26.4	32.4 - 39.6	43.2 - 52.8
	Over Current Protection (*8)	A	>15.7		>7.88	>6.25	>4.00	>2.6	>2.0
	Over Voltage Protection (*9)	VDC	3.79 - 4.95	5.75 - 7.00	13.8 - 16.2	17.3 - 20.3	27.6 - 32.4	41.4 - 48.6	55.2 - 64.8
	Remote ON/OFF Control		Possible						
	Parallel Operation		-						
Environment	Series Operation		Possible						
	Operating Temperature (*12)	°C	-10 to 60 Convection : -10 to 50: 100%, +60: 70%						
	Storage Temperature	°C	-30 to +85						
	Operating Humidity	%RH	30 - 90 (No dewdrop)						
	Storage Humidity	%RH	10 - 95 (No dewdrop)						
	Vibration		At no operating, 10-55Hz (sweep for 1min) 19.6m/s² constant, X, Y, Z 1hour each.						
	Shock (In package)		Less than 196.1m/s²						
Isolation	Cooling		Convection cooling						
	Withstand Voltage		Input - FG : 2kVAC (20mA), Input - Output : 3kVAC (20mA) Output - FG : 500VAC (100mA) for 1min						
Standards	Isolation Resistance		More than 100MΩ at 25°C and 70%RH Output - FG : 500VDC						
	Safety Standards (*13)		Approved by UL60950-1, CSA C22.2 No.60950-1, EN60950-1, EN50178. Built to meet DENAN.						
	PFHC		Built to meet EN61000-3-2						
	EMI		Built to meet EN55011/EN55022-B, FCC-ClassB, VCCI-B.						
Mechanical	Immunity		Built to meet EN61000-4-2, -3, -4, -5, -6, -8, -11						
	Weight (typ)	g	290						
	Size (W x H x D)	mm	55 x 32 x 222 (Refer to outline drawing)						

(*1) Operating period at peak output current is less than 10 sec.
(Average output power and current is less than maximum output power and current.)

(*2) At 100/200VAC, Ta=25°C and maximum output power.

(*3) For cases where conformance to various safety specs (UL, CSA, EN) are required, to be described as 100-240VAC (50/60Hz).

(*4) Not applicable for the in-rush current to noise filter for less than 0.2ms.

(*5) Please refer to Fig. A for measurement of line & load regulation and ripple voltage.
(Measure with JEITA RC-9131 probe.)

(*6) 85 - 265VAC, constant load.

(*7) No load-maximum load, constant input voltage.

(*8) Constant current limit with automatic recovery.
Not operate at overload or dead short condition for more than 30 seconds.

(*9) OVP circuit will shut down output, manual reset. (Line recycle)

(*10) At 100/200VAC nominal output voltage and maximum output current.

(*11) Measured by the each measuring method of UL, CSA, EN and DENAN (at 60Hz).

(*12) At standard mounting.
- Load (%) is percent of maximum output power or maximum output current, whichever is greater.
- For other mountings, refer to derating curve.
- When forced air cooling, refer to derating curve.

(*13) As for DENAN, built to meet at 100VAC.

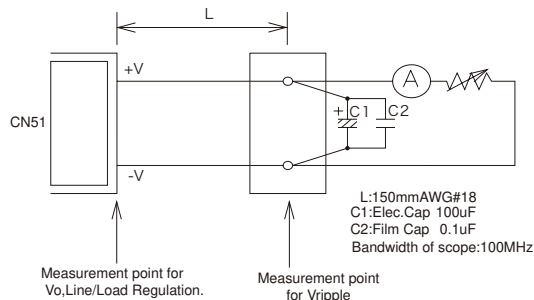
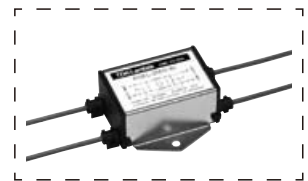

Fig.A

Recommended EMC Filter



RSEL-2002W

Please refer to "TDK-Lambda EMC Filters" catalog.

Outline Drawing

[ZWS75AF (/J : JST connector)]

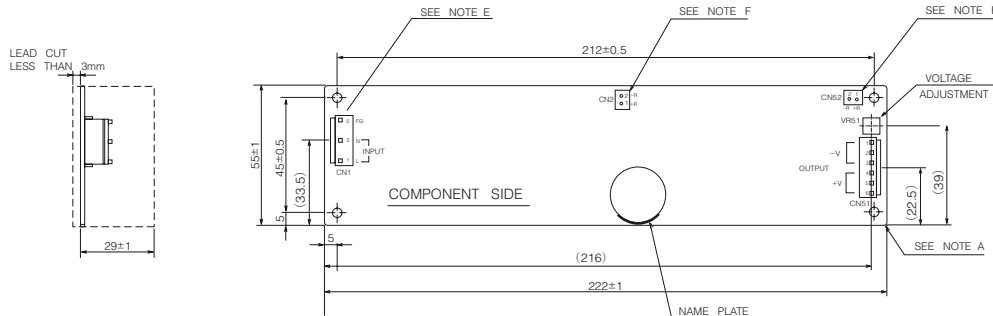

(unit : mm)

CONNECTORS USED:

PART DESCRIPTION	PART NAME	MANUFACT.	QTY
PIN HEADER (INPUT SIDE CN1)	B3P-5-VH	J.S.T.	1
PIN HEADER (OUTPUT SIDE CN51)	B6P-VH	J.S.T.	1

*OUTPUT CURRENT OF EACH CONNECTOR PIN MUST BE LESS THAN 5A.

MATCHING HOUSINGS & PINS (NOT INCLUDED WITH THE PRODUCT):

SOCKET HOUSING (CN1)	VHR-5N	J.S.T.	1
SOCKET HOUSING (CN51)	VHR-6N	J.S.T.	1
TERMINAL PINS (CN1, 51)	SVH-21T-P1.1	J.S.T.	9

HAND CRIMPING TOOL : YC-160R MANUFACTURER : J.S.T.

PCB MATERIAL
GLASS COMPOSITE : CEM-3 UL94V-0

※I/O connectors: MOLEX is also available.

NOTES

- A: THE 4- ϕ 3.5 HOLES ARE FOR CUSTOMER'S CHASSIS MOUNTING HOLES. ALL MUST BE SCREWED IN ORDER TO CONFORM TO THE VIBRATION SPEC.
- B: MODEL NAME, INPUT VOLTAGE RANGE, NOMINAL OUTPUT VOLTAGE, MAXIMUM OUTPUT CURRENT ARE SHOWN HERE IN ACCORDANCE WITH THE SPECIFICATIONS.
- C: COUNTRY OF MANUFACTURE WILL BE SHOWN HERE.
- D: TO KEEP THE DISTANCE MORE THAN 4mm BETWEEN PCB EDGE AND CUSTOMER'S CHASSIS.
- E: FG IS FOR SAFETY GROUND CONNECTION.
- F: REMOVE ON/OFF CONTROL CONNECTOR (CN2,CN52) : B2B-XH-AM (J.S.T.) *CN2 IS NORMALLY SHORTED BY JM-2W-96 (J.S.T.)
- MATCHING HOUSING : XHP-2 (J.S.T.)
- MATCHING TERMINAL : BXH-001T-P0.6 (J.S.T.) OR SXH-001T-P0.6 (J.S.T.)
- HAND CRIMPING TOOL : YC-110R OR YRS-110 MANUFACTURER : J.S.T.
- G: PIN-ORDER OF CONNECTORS CN1 & CN51 ARE OPPOSITE TO PIN-ORDER ON LEG-END.
- H: FOR I/O TERMINAL CONNECTIONS, PLEASE USE THE RECOMMENDED CONNECTORS.

[ZWS75AF (/JA : With cover)]

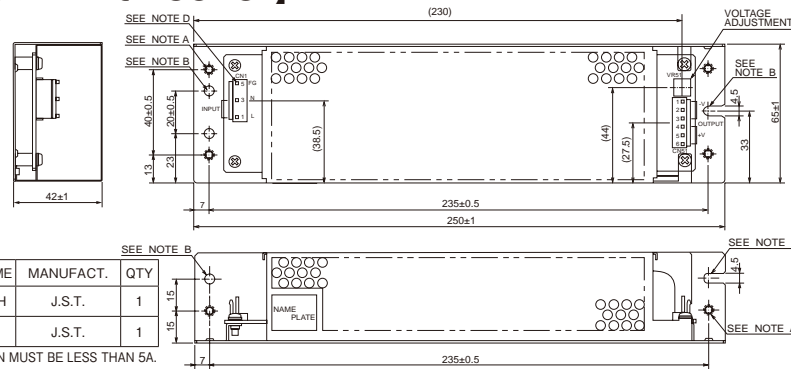

NOTES

- A: M4 EMBOSSED TAPPED & COUNTERSUNK HOLES (6) FOR CUSTOMER CHASSIS MOUNTING.
- B: ϕ 4.5 HOLES (3) AND R2.25 SLOT HOLES (2) FOR CUSTOMER CHASSIS MOUNTING.
- C: MODEL NAME, NOMINAL OUTPUT VOLTAGE, MAXIMUM OUTPUT CURRENT, PEAK OUTPUT CURRENT AND COUNTRY OF MANUFACTURE ARE SHOWN HERE IN ACCORDANCE WITH THE SPECIFICATIONS.
- D: FG IS FOR SAFETY GROUND CONNECTION.
- E: PIN-ORDER OF CONNECTORS CN1 & CN51 ARE OPPOSITE TO PIN-ORDER ON LEGEND.

CONNECTORS USED:

PART DESCRIPTION	PART NAME	MANUFACT.	QTY
PIN HEADER (INPUT SIDE CN1)	B3P-5-VH	J.S.T.	1
PIN HEADER (OUTPUT SIDE CN51)	B6P-VH	J.S.T.	1

*OUTPUT CURRENT OF EACH CONNECTOR PIN MUST BE LESS THAN 5A.

MATCHING HOUSINGS & PINS (NOT INCLUDED WITH THE PRODUCT):

SOCKET HOUSING (CN1)	VHR-5N	J.S.T.	1
SOCKET HOUSING (CN51)	VHR-6N	J.S.T.	1
TERMINAL PINS (CN1,51)	SVH-21T-P1.1	J.S.T.	9

HAND CRIMPING TOOL : YC-160R MANUFACTURER : J.S.T.

(unit : mm)

Output Derating

Convection Cooling
Output Derating Curve (Without cover)

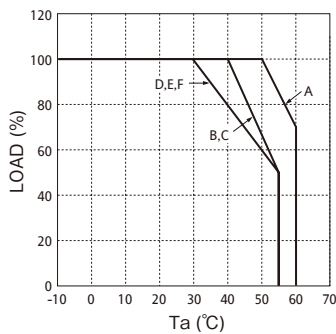

Convection Cooling
Output Derating Curve (With cover)

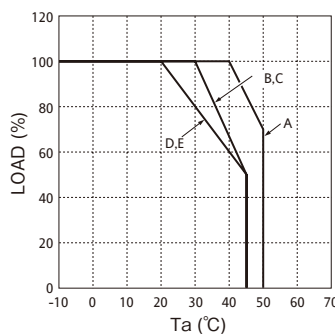

Forced Air Cooling
Output Derating Curve

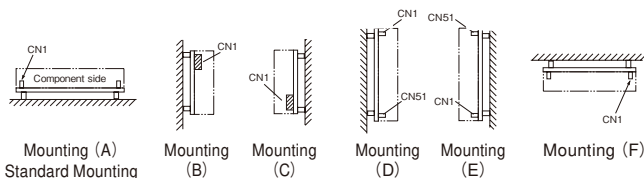
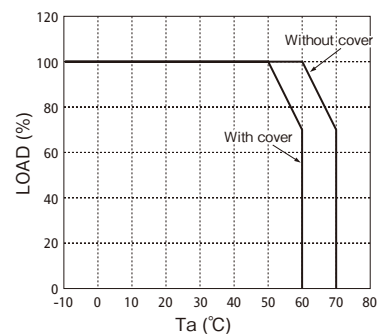

Recommended standard mounting method is (A).

The output derating may vary due to mounting method and ambient temperature. Please use within the range of derating above.

In the derating curve, maximum output current or maximum output power in specification refers 100%.

*Please do not use (F) with cover.

Recommended Minimum Air Velocity : 0.7m/s (Measured at component side of PCB, Air must flow through component side.).

As a reference for forced air cooling, let air flow so that the temperature of electrolytic capacitor C6 is lower than 85°C.

ZWS100AF Specifications

ITEMS/UNITS		MODEL	ZWS100AF-3	ZWS100AF-5	ZWS100AF-12	ZWS100AF-15	ZWS100AF-24	ZWS100AF-36	ZWS100AF-48
Input	Voltage Range (*3)	V	AC85 - 265 or DC120 - 370						
	Frequency (*3)	Hz	47-63						
	Power Factor (100/200VAC)(typ)(*2)		0.98 / 0.93		0.99 / 0.95				
	Efficiency (typ) (*2)	%	69	75	79	81	82		
	Current (100/200VAC)(typ) (*2)	A	1.0 / 0.5		1.4 / 0.7				
	Inrush Current (100/200VAC)(typ)(*4)	A	14 / 28 at, Ta=25°C, cold start						
	Leakage Current (*11)	mA	0.5MAX, 0.1 (typ) at 100VAC / 0.16 (typ) at 230VAC						
Output	Nominal Voltage	VDC	3.3	5	12	15	24	36	48
	Maximum Current	A	20	20	8.5	6.7	4.3	2.8	2.1
	Maximum Peak Current (*1)	A	-		10	8	5	3.4	2.5
	Maximum Power	W	66	100	102	100.5	103.2	100.8	
	Maximum Peak Power (*1)	W	-		120			122.4	120
	Maximum Line Regulation (*5)(*6)	mV	20		48	60	96	144	192
	Maximum Load Regulation (*5)(*7)	mV	40		96	120	150	200	240
	Temperature Coefficient		Less than 0.02%/°C						
	Maximum Ripple & Noise (0≤Ta≤60°C)(*5)	mVp-p	120		150			200	
	Maximum Ripple & Noise (-10≤Ta<0°C)(*5)	mVp-p	160		180			240	
	Hold-up Time (typ) (*10)	ms	20						
Function	Voltage Adjustable Range	VDC	2.85 - 3.63	4.5 - 5.5	10.8 - 13.2	13.5 - 16.5	21.6 - 26.4	32.4 - 39.6V	43.2 - 52.8
	Over Current Protection (*8)	A	21.0 -		10.6 -	8.38 -	5.38 -	3.5A -	2.62 -
	Over Voltage Protection (*9)	VDC	3.79 - 4.95	5.75 - 7.00	13.8 - 16.2	17.3 - 20.3	27.6 - 32.4	41.4 - 48.6V	55.2 - 64.8
	Remote ON/OFF Control		Possible						
Environment	Parallel Operation		-						
	Series Operation		Possible						
	Operating Temperature (*12)	°C	-10 to +60 Convection : -10 to +50: 100%, +60: 60%						
Isolation	Storage Temperature	°C	-30 to +85						
	Operating Humidity	%RH	30 - 90 (No dewdrop)						
	Storage Humidity	%RH	10 - 95 (No dewdrop)						
	Vibration		At no operating, 10-55Hz (sweep for 1min) 19.6m/s² constant, X, Y, Z 1hour each.						
	Shock (In package)		Less than 196.1m/s²						
	Cooling		Convection cooling						
	Withstand Voltage		Input - FG : 2kVAC (20mA), Input - Output : 3kVAC (20mA) Output - FG : 500VAC (100mA) for 1min						
Standards	Isolation Resistance		More than 100MΩ at 25°C and 70%RH Output - FG : 500VDC						
	Safety Standards (*13)		Approved by UL60950-1, CSA C22.2 No.60950-1, EN60950-1, EN50178. Built to meet DENAN.						
	PFHC		Built to meet EN61000-3-2						
	EMI		Built to meet EN55011/EN55022-B, FCC-ClassB, VCCI-B.						
Mechanical	Immunity		Built to meet EN61000-4-2, -3, -4, -5, -6, -8, -11						
	Weight (typ)	g	380						
	Size (W x H x D)	mm	62 x 35 x 222 (Refer to outline drawing)						

- (*1) Operating period at peak output current is less than 10 sec.
(Average output power and current is less than maximum output power and current.)
- (*2) At 100/200VAC, Ta=25°C and maximum output power.
- (*3) For cases where conformance to various safety specs (UL, CSA, EN) are required, to be described as 100 - 240VAC (50/60Hz).
- (*4) Not applicable for the in-rush current to noise filter for less than 0.2ms.
- (*5) Please refer to Fig. A for measurement of line & load regulation and ripple voltage.
(Measure with JEITA RC-9131 probe.)
- (*6) 85 - 265VAC, constant load.
- (*7) No load-maximum load, constant input voltage.
- (*8) Constant current limit with automatic recovery.
Not operate at overload or dead short condition for more than 30 seconds.
- (*9) OVP circuit will shut down output, manual reset. (Line recycle)
- (*10) At 100/200VAC nominal output voltage and maximum output current.
- (*11) Measured by the each measuring method of UL, CSA, EN and DENAN (at 60Hz).
- (*12) At standard mounting.
 - Load(%) is percent of maximum output power or maximum output current, whichever is greater.
 - For other mountings, refer to derating curve.
 - When forced air cooling, refer to derating curve.
- (*13) As for DENAN, built to meet at 100VAC.

● Recommended EMC Filter



RSEL-2002W
Please refer to "TDK-Lambda EMC Filters" catalog.

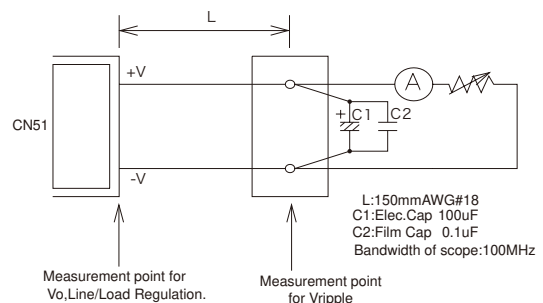
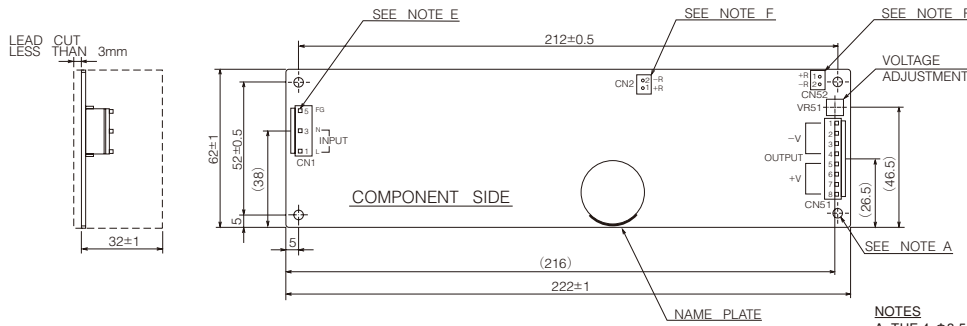

Fig.A

Outline Drawing

[ZWS100AF (/J : JST connector)]

PCB MATERIAL
GLASS COMPOSITE : CEM-3 UL94V-0



(unit : mm)

CONNECTORS USED:

PART DESCRIPTION	PART NAME	MANUFACT.	QTY
PIN HEADER (INPUT SIDE CN1)	B3P-5-VH	J.S.T	1
PIN HEADER (OUTPUT SIDE CN51)	B8P-VH	J.S.T	1

*OUTPUT CURRENT OF EACH CONNECTOR PIN MUST BE LESS THAN 5A.

MATCHING HOUSINGS & PINS (NOT INCLUDED WITH THE PRODUCT):

SOCKET HOUSING (CN1)	VHR-5N	J.S.T	1
SOCKET HOUSING (CN51)	VHR-8N	J.S.T	1
TERMINAL PINS (CN1, CN51)	SVH-21T-P1.1	J.S.T	11

HAND CRIMPING TOOL : YC-160R MANUFACTURER : J.S.T.

*I/O connectors: MOLEX is also available.

NOTES

- A: THE 4- ϕ 3.5 HOLES ARE FOR CUSTOMER'S CHASSIS MOUNTING HOLES. ALL MUST BE SCREWED IN ORDER TO CONFORM THE VIBRATION SPEC.
- B: MODEL NAME, INPUT VOLTAGE RANGE, NOMINAL OUTPUT VOLTAGE, MAXIMUM OUTPUT CURRENT ARE SHOWN HERE IN ACCORDANCE WITH THE SPECIFICATIONS.
- C: COUNTRY OF MANUFACTURE WILL BE SHOWN HERE.
- D: TO KEEP THE DISTANCE MORE THAN 4mm BETWEEN PCB EDGE AND CUSTOMER'S CHASSIS.
- E: FG IS FOR SAFETY GROUND CONNECTION.
- F: REMOTE ON/OFF CONTROL CONNECTOR (CN2,CN52) : B2B-XH-AM (J.S.T.)
*CN2 IS NORMALLY SHORTED BY JM-2W-96 (J.S.T.)
MATCHING HOUSING : XHP-2 (J.S.T.)
MATCHING TERMINAL : BXH-001T-P0.6 (J.S.T.) OR SXH-001T-P0.6 (J.S.T.)
HAND CRIMPING TOOL : YC-110R OR YRS-110
MANUFACTURER : J.S.T.
- G: PIN-ORDER OF CONNECTORS CN1 & CN51 ARE OPPOSITE TO PIN-ORDER ON LEGEND.
- H: FOR I/O TERMINAL CONNECTIONS, PLEASE USE THE RECOMMENDED CONNECTORS.

[ZWS100AF (/JA : With cover)]

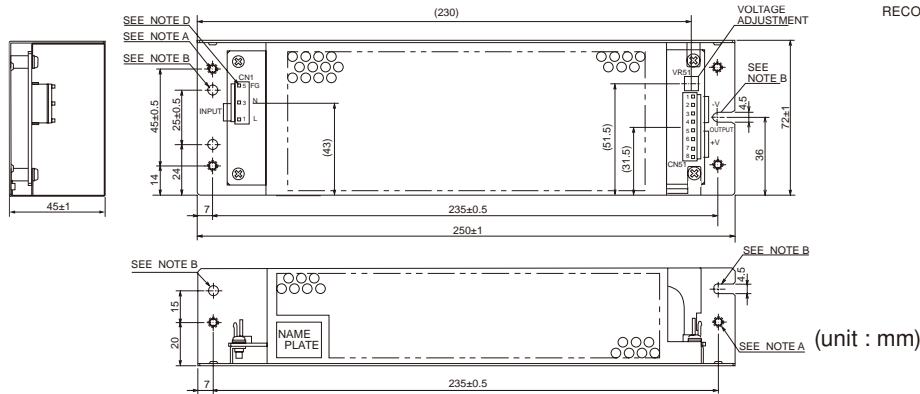

(unit : mm)

CONNECTORS USED:

PART DESCRIPTION	PART NAME	MANUFACT.	QTY
PIN HEADER (INPUT SIDE CN1)	B3P-5-VH	J.S.T	1
PIN HEADER (OUTPUT SIDE CN51)	B8P-VH	J.S.T	1

*OUTPUT CURRENT OF EACH CONNECTOR PIN MUST BE LESS THAN 5A.

MATCHING HOUSINGS & PINS (NOT INCLUDED WITH THE PRODUCT):

SOCKET HOUSING (CN1)	VHR-5N	J.S.T	1
SOCKET HOUSING (CN51)	VHR-8N	J.S.T	1
TERMINAL PINS (CN1,51)	SVH-21T-P1.1	J.S.T	11

HAND CRIMPING TOOL : YC-160R MANUFACTURER : J.S.T.

NOTES

- A: M4 EMBOSSED TAPPED & COUNTERSUNK HOLES (6) FOR CUSTOMER CHASSIS MOUNTING.
- B: ϕ 4.5 HOLES (3) AND R2.25 SLOT HOLES (2) FOR CUSTOMER CHASSIS MOUNTING.
- C: MODEL NAME, NOMINAL OUTPUT VOLTAGE, MAXIMUM OUTPUT CURRENT, PEAK OUTPUT CURRENT AND COUNTRY OF MANUFACTURE ARE SHOWN HERE IN ACCORDANCE WITH THE SPECIFICATIONS.
- D: FG IS FOR SAFETY GROUND CONNECTION.
- E: PIN-ORDER OF CONNECTORS CN1 & CN51 ARE OPPOSITE TO PIN-ORDER ON LEGEND.

Output Derating

**Convection Cooling
Output Derating Curve (Without cover)**

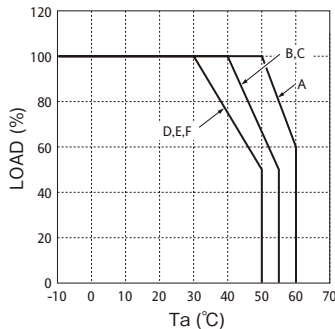

**Convection Cooling
Output Derating Curve (With cover)**

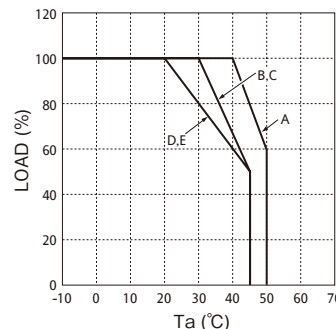

**Forced Air Cooling
Output Derating Curve**

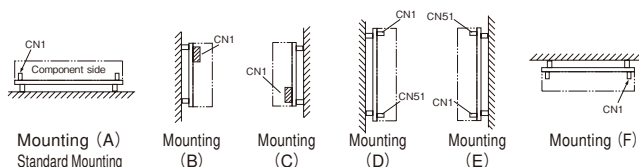
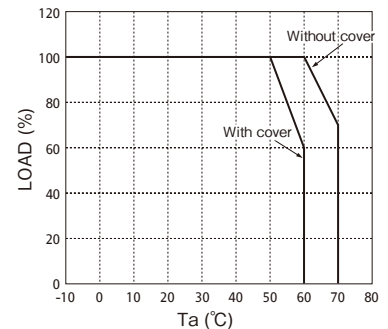

Recommended standard mounting method is (A).

The output derating may vary due to mounting method and ambient temperature. Please use within the range of derating above. In the derating curve, maximum output current or maximum output power in specification refers 100%.

* Please do not use (F) with cover.

Recommended Minimum Air Velocity : 0.7m/s (Measured at component side of PCB, Air must flow through component side).

As a reference for forced air cooling, let air flow so that the temperature of electrolytic capacitor C6 is lower than 85°C.

ZWS150AF Specifications

ITEMS/UNITS		MODEL	ZWS150AF-3	ZWS150AF-5	ZWS150AF-12	ZWS150AF-15	ZWS150AF-24	ZWS150AF-36	ZWS150AF-48	
Input	Voltage Range (*3)	V	AC85 - 265 or DC120 - 370							
	Frequency (*3)	Hz	47-63							
	Power Factor (100/200VAC)(typ)(*2)		0.99 / 0.95							
	Efficiency (typ) (*2)	%	74	77	79	81	82			
	Current (100/200VAC)(typ) (*2)	A	1.4 / 0.7	2.0 / 1.0						
	Inrush Current (100/200VAC)(typ)(*4)	A	14 / 28 at, Ta=25°C, cold start							
	Leakage Current (*11)	mA	0.5 MAX, 0.1mA (typ) at 100VAC / 0.16mA (typ) at 230VAC							
Output	Nominal Voltage	VDC	3.3	5	12	15	24	36	48	
	Maximum Current	A	30		12.5	10	6.3	4.2	3.2	
	Maximum Peak Current (*1)	A	-		15	12	7.5	5	3.8	
	Maximum Power	W	99	150			151.2		153.6	
	Maximum Peak Power (*1)	W	-		180			182.4		
	Maximum Line Regulation (*5)(*6)	mV	20	48		60	96	144	192	
	Maximum Load Regulation (*5)(*7)	mV	40	96		120	150	200	240	
	Temperature Coefficient		Less than 0.02%/°C							
	Maximum Ripple & Noise (0≤Ta≤60°C)(*5)	mVp-p	120		150			200		
	Maximum Ripple & Noise (-10≤Ta≤0°C)(*5)	mVp-p	160		180			240		
	Hold-up Time (typ) (*10)	ms	20							
Function	Voltage Adjustable Range	VDC	2.97 - 3.63	4.5 - 5.5	10.8 - 13.2	13.5 - 16.5	21.6 - 26.4	32.4 - 39.6	43.2 - 52.8	
	Over Current Protection (*8)	A	>31.5		>15.7	>12.5	>7.87	>5.25	>4	
	Over Voltage Protection (*9)	VDC	3.79 - 4.95	5.75 - 7.00	13.8 - 16.2	17.3 - 20.3	27.6 - 32.4	41.4 - 48.6	55.2 - 64.8	
	Remote ON/OFF Control		Possible							
	Parallel Operation		-							
Environment	Operating Temperature (*12)	°C	-10 to +60 Convection : -10 to +40: 100%, +60: 50%							
	Storage Temperature	°C	-30 to +85							
	Operating Humidity	%RH	30 - 90 (No dewdrop)							
	Storage Humidity	%RH	10 - 95 (No dewdrop)							
	Vibration		At no operating, 10-55Hz (sweep for 1min) 19.6m/s² constant, X, Y, Z 1hour each.							
	Shock (In package)		Less than 196.1m/s²							
	Cooling		Convection cooling							
Isolation	Withstand Voltage		Input - FG : 2kVAC (20mA), Input - Output : 3kVAC (20mA) Output - FG : 500VAC (100mA) for 1min							
	Isolation Resistance		More than 100MΩ at 25°C and 70%RH Output - FG : 500VDC							
Standards	Safety Standards (*13)		Approved by UL60950-1, CSA C22.2 NO.60950-1, EN60950-1. Built to meet DENAN							
	PFHC		Built to meet EN61000-3-2							
	EMI		Built to meet EN55011/EN55022-B, FCC-ClassB, VCCI-B.							
Mechanical	Immunity		Built to meet EN61000-4-2, -3, -4, -5, -6, -8, -11							
	Weight (typ)	g	500							
	Size (W x H x D)	mm	75 x 40 x 222 (Refer to outline drawing)							

(*1) Operating period at peak output current is less than 10 sec. (Average output power and current is less than maximum output power and current.)

(*2) At 100/200VAC, Ta=25°C and maximum output power.

(*3) For cases where conformance to various safety specs (UL, CSA, EN) are required, to be described as 100-240VAC (50/60Hz).

(*4) Not applicable for the in-rush current to noise filter for less than 0.2ms.

(*5) Please refer to Fig. A for measurement of line & load regulation and ripple voltage. (Measure with JEITA RC-9131 probe.)

(*6) 85 - 265VAC, constant load.

(*7) No load - maximum load, constant input voltage.

(*8) Constant current limit with automatic recovery. Not operate at overload or dead short condition for more than 30 seconds.

(*9) OVP circuit will shut down output, manual reset. (Line recycle)

(*10) At 100/200VAC nominal output voltage and maximum output current.

(*11) Measured by the each measuring method of UL, CSA, EN and DENAN (at 60Hz).

(*12) At standard mounting.
- Load(%) is percent of maximum output power or maximum output current, whichever is greater.
- For other mountings, refer to derating curve.
- When forced air cooling, refer to derating curve.

(*13) As for DENAN, built to meet at 100VAC.

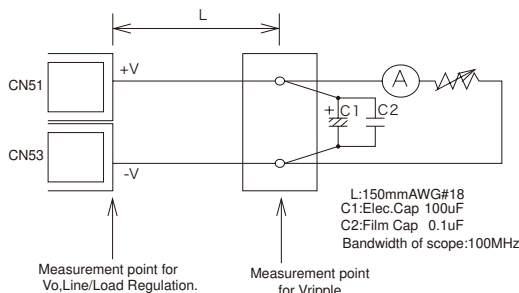

Fig.A

Recommended EMC Filter



RSEL-2003W

Please refer to "TDK-Lambda EMC Filters" catalog.

ZWS300 Specifications

ITEMS/UNITS		MODEL	ZWS300-3	ZWS300-5	ZWS300-12	ZWS300-15	ZWS300-24	ZWS300-48	
Input	Voltage Range (*3)	V	AC85 - 132 / 170 - 265						
	Frequency (*3)	Hz	47 - 440						
	Efficiency (100/200VAC)(typ) (*2)	%	72 / 74	78 / 81	80 / 83	81 / 84	83 / 86		
	Current (100/200VAC)(typ) (*2)	A	5 / 3	7.5 / 4.5					
	Inrush Current (100/200VAC)(typ) (*4)	A	15 / 30 at, Ta=25°C, cold start						
	Leakage Current (*12)	mA	0.75 MAX, 0.2 (typ) at 100VAC / 0.44 (typ) at 230VAC						
Output	Nominal Voltage	VDC	3.3	5	12	15	24	48	
	Maximum Current (Convection)	A	40		17	14	9	4.2	
	Maximum Current (Forced air)	A	60		27	22	14	6.3	
	Maximum Peak Current (*1)	A	60		27	22	14	6.3	
	Maximum Power (Convection)	W	132	200	204	210	216	201.6	
	Maximum Power (Forced air)	W	198	300	324	330	336	302.4	
	Maximum Peak Power (*1)	W	198	300	324	330	336	302.4	
	Maximum Line Regulation (*6)	mV	20		48	60	96	192	
	Maximum Load Regulation (*7)	mV	40		100	120	150	240	
	Temperature Coefficient (*8)		Less than 0.02%/°C						
	Maximum Ripple & Noise (0 to +50°C)(*5)	mVp-p	120		150		400		
	Maximum Ripple & Noise (-10 to 0°C) (*5)	mVp-p	160		180		600		
	Hold-up Time (typ) (*11)	ms	20						
	Function	Voltage Adjustable Range	VDC	2.85 - 3.6	4.5 - 5.5	10.8 - 13.2	13.5 - 16.5	21.6 - 26.4	43.2 - 52.8
Over Current Protection (*9)		A	>63						
Over Voltage Protection (*10)		VDC	4.00 - 5.25	5.8 - 7.0	13.8 - 16.8	17.3 - 21.0	27.6 - 33.6	55.2 - 67.2	
Remote Sensing			Possible						
Remote ON/OFF Control			-						
Parallel Operation			-						
Series Operation			Possible						
Operating Temperature (*13)		°C	-10 to +70 (-10 to +40: 100%, +60: 60%, +70: 50%)						
Storage Temperature		°C	-30 to +85						
Environment		Operating Humidity	%RH	20 - 90 (No dewdrop)					
	Storage Humidity	%RH	10 - 95 (No dewdrop)						
	Vibration		At no operating, 10-55Hz (sweep for 1min) 19.6m/s ² constant, X, Y, Z 1hour each.						
	Shock		Less than 196.1m/s ²						
	Cooling (*13)		Convection & forced air cooling						
	Isolation	Withstand Voltage		Input - FG : 2kVAC (10mA), Input - Output : 3kVAC (10mA) Output - FG : 500VAC (100mA) for 1min					
		Isolation Resistance		More than 100MΩ at 25°C and 70%Rh Input - FG, Input - Output, Output - FG... 500VDC					
Standards	Safety Standards		Approved by UL60950-1, CSA C22.2 No.60950-1, EN60950-1. Built to meet DENAN.						
	EMI		Built to meet EN55011/EN55022-B, FCC-ClassB, VCCI-B.						
Mechanical	Weight (typ)	g	1000						
	Size (W x H x D)	mm	108 x 50 x 255 (Refer to outline drawing)						

(*1) Duration under peak application is limited less than 30 seconds.
(Average output current under those condition should not exceed maximum output current.)

(*2) At 100/200VAC, Ta=25°C and maximum output power.

(*3) 100-120/200-240VAC indicated on the name plate in accordance with safety application (UL, CSA, EN, etc.).

(*4) First inrush current. Not applicable for the in-rush current to noise filter less than 0.2ms.

(*5) Measure with JEITA RC-9131 probe, Bandwidth of scope: 100MHz. At maximum output power (convection).
(With an external Elec., Cap of 22μF connected 150mm (maximum) far from the output terminal.)

(*6) 85-132/170-265VAC, constant load.

(*7) No load-full load, constant input voltage.

(*8) At 100/200VAC, maximum output power and Ta=-10 to +70°C.

(*9) Constant current limit with automatic recovery.

(*10) OVP circuit will shut down output, manual reset (line recycle).

(*11) At 100/200VAC nominal output voltage and maximum output current.

(*12) Measured by the each measuring method of UL, CSA, EN and DENAN (at 60Hz), Ta=25°C

(*13) Ratings - Derating at standard mounting.
- Load(%) is percent of maximum output power or maximum output current, whichever is greater.
- As for other mountings, refer to derating curve.
- When forced air cooling, refer to derating curve.

● Recommended EMC Filter



RSEN-2010

Please refer to "TDK-Lambda EMC Filters" catalog.

Outline Drawing

[ZWS300-□ (Standard : Horizontal terminal)]

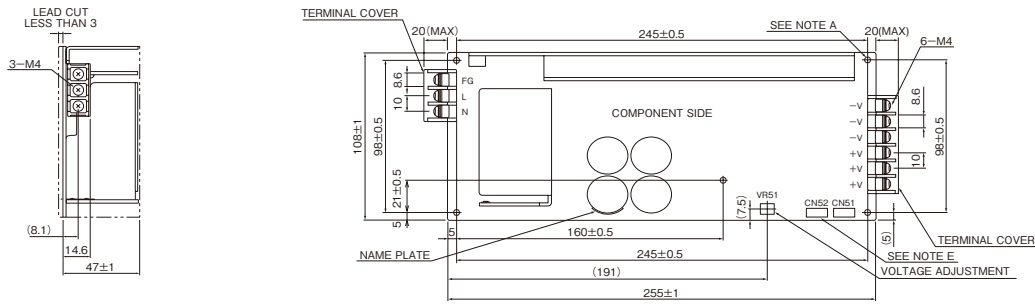

(unit : mm)

PCB MATERIAL
GLASS COMPOSITE : CEM-3 UL94V-0

ACCESSORIES
COVER FOR BARRIER TERMINAL STRIP --- 2
(MOUNTED ON TERMINAL STRIP AT TIME OF SHIPMENT.)
SHORT PIECES FOR CONNECTING +S to +LS, -S to -LS (CN51) --- 2

NOTES
A: 5-φ3.5 HOLES FOR CUSTOMER'S CHASSIS MOUNTING HOLES.
ALL MUST BE SCREWED IN ORDER TO CONFORM THE VIBRATION SPEC.
B: MODEL NAME, OPTION, INPUT VOLTAGE RANGE, NOMINAL OUTPUT VOLTAGE, MAXIMUM OUTPUT CURRENT ARE SHOWN HERE IN ACCORDANCE WITH THE SPECIFICATIONS.
C: COUNTRY OF MANUFACTURE WILL BE SHOWN HERE.

D: TO KEEP THE DISTANCE MORE THAN 4mm BETWEEN PCB EDGE AND CUSTOMER'S CHASSIS.
E: REMOTE & LOCAL SENSING CONNECTOR : B4B-XH-AM (JST)
MATCHING HOUSING : XHP-4 (JST)
MATCHING TERMINAL : BXH-001T-P0.6 (JST) OR SXH-001T-P0.6 (JST)
PIN ASSIGNMENT
PIN 1 : -LS (LOCAL SENSING)
PIN 2 : -S (REMOTE SENSING)
PIN 3 : +S (REMOTE SENSING)
PIN 4 : +LS (LOCAL SENSING)
* CN51 IS NORMALLY SHORTED BY JM-2W-96(JST)

[ZWS300-□ / T (Vertical Terminal)]

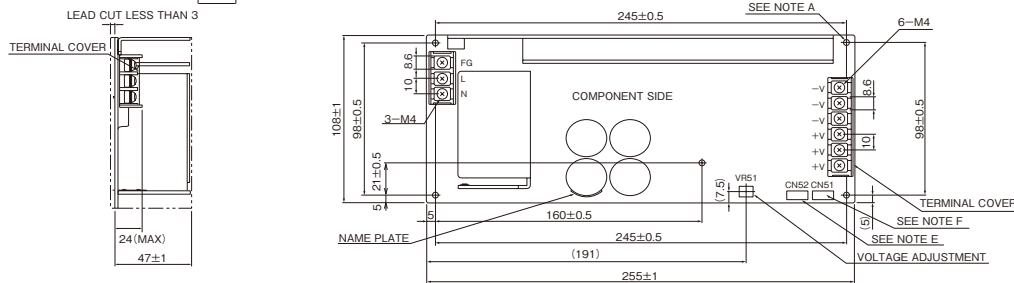

(unit : mm)

PCB MATERIAL
GLASS COMPOSITE : CEM-3 UL94V-0

ACCESSORIES
COVER FOR BARRIER TERMINAL STRIP --- 2 (MOUNTED ON TERMINAL STRIP AT TIME OF SHIPMENT.)
SHORT PIECES FOR CONNECTING +S to +LS, -S to -LS (CN51) --- 2

NOTES
A: 5-φ3.5 HOLES FOR CUSTOMER'S CHASSIS MOUNTING HOLES. ALL MUST BE SCREWED IN ORDER TO CONFORM THE VIBRATION SPEC.
B: MODEL NAME, OPTION, INPUT VOLTAGE RANGE, NOMINAL OUTPUT VOLTAGE, MAXIMUM OUTPUT CURRENT ARE SHOWN HERE IN ACCORDANCE WITH THE SPECIFICATIONS.
C: COUNTRY OF MANUFACTURE WILL BE SHOWN HERE.
D: TO KEEP THE DISTANCE MORE THAN 4mm BETWEEN PCB EDGE AND CUSTOMER'S CHASSIS.

E: REMOTE ON/OFF CONTROL CONNECTOR : B2B-XH-AM (JST) ----- OPTION
MATCHING HOUSING : XHP-2 (JST)
MATCHING TERMINAL : BXH-001T-P0.6 (JST) OR SXH-001T-P0.6 (JST)
F: REMOTE & LOCAL SENSING CONNECTOR : B4B-XH-AM (JST)
MATCHING HOUSING : XHP-4 (JST)
MATCHING TERMINAL : BXH-001T-P0.6 (JST) OR SXH-001T-P0.6 (JST)
PIN ASSIGNMENT
PIN 1 : -LS (LOCAL SENSING)
PIN 2 : -S (REMOTE SENSING)
PIN 3 : +S (REMOTE SENSING)
PIN 4 : +LS (LOCAL SENSING)

OPTIONAL MODELS

MODEL	REMOTE ON/OFF CONTROL
ZWS300-√T	-
ZWS300-√RT	○

[ZWS300-□ / B: Input connector (Applicable to 12, 15, 24, 48 Vout types)]

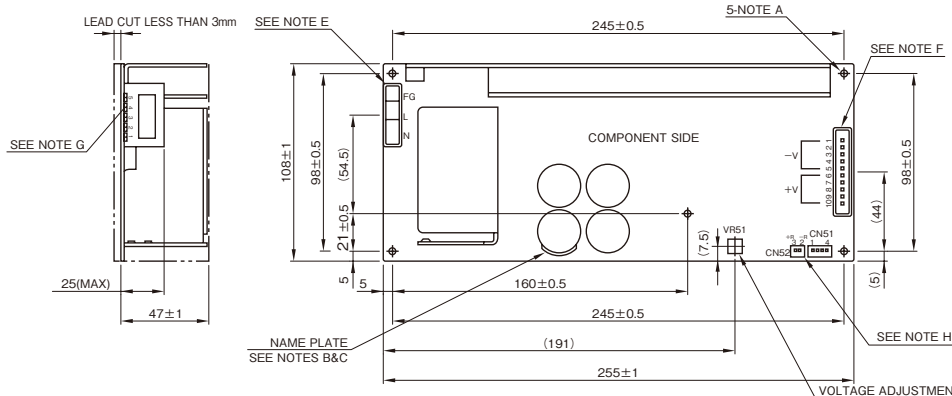

(unit : mm)

ACCESSORIES
SHORT PIECES FOR CONNECTING +S to +LS, -S to -LS (CN51) --- 2
(MOUNTED AT TIME OF SHIPMENT)
PCB MATERIAL
GLASS COMPOSITE : CEM-3 UL94V-0

OPTIONAL MODELS

MODEL	REMOTE ON/OFF CONTROL
ZWS300-√B	-
ZWS300-√RB	○

NOTES
A: 5-φ3.5 HOLES FOR CUSTOMER'S CHASSIS MOUNTING HOLES. ALL MUST BE SCREWED IN ORDER TO CONFORM THE VIBRATION SPEC.
B: MODEL NAME, OPTION, INPUT VOLTAGE RANGE, NOMINAL OUTPUT VOLTAGE, MAXIMUM OUTPUT CURRENT ARE SHOWN HERE IN ACCORDANCE WITH THE SPECIFICATIONS.
C: COUNTRY OF MANUFACTURE WILL BE SHOWN HERE.
D: TO KEEP THE DISTANCE MORE THAN 4mm BETWEEN PCB EDGE AND CUSTOMER'S CHASSIS.
E: CONNECTOR: 1-316132-5 (A.M.P) (MATCHING HOUSING : 1-178128-5 (A.M.P) *1
F: CONNECTOR: 1-178318-5 (A.M.P) (MATCHING HOUSING : 1-178288-8 (A.M.P) *1
*1: MATCHING CONTACT
WIRE SIZE
AWG20-16 : 1-175218-5 (A.M.P) OR 1-175196-5 (A.M.P)
AWG16-12 : 1-917511-5 (A.M.P) OR 1-917484-5 (A.M.P)
G: NO CONTACT PIN No.2.4
H: REMOTE ON/OFF CONTROL CONNECTOR : B2B-XH-AM (JST) -----OPTION
MATCHING HOUSING : XHP-2 (JST)
MATCHING TERMINAL : BXH-001T-P0.6 (JST) OR SXH-001T-P0.6 (JST)

* All specifications are subject to change without notice.

Output Derating (Without Cover)

Convection Cooling
Output Derating Curve

[ZWS5]

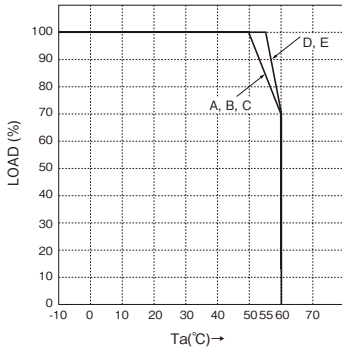

[ZWS10]

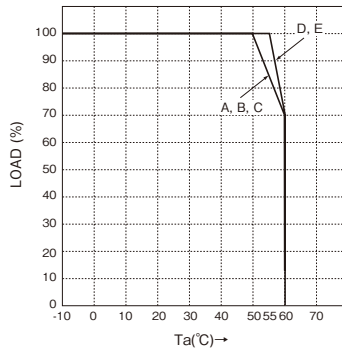

[ZWS15]

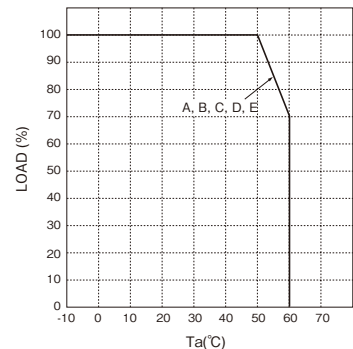

[ZWS30]

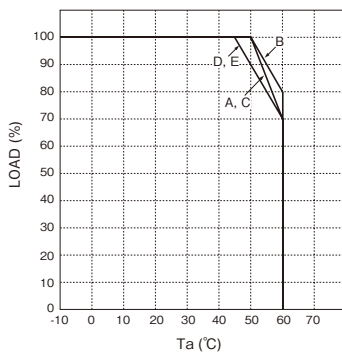

[ZWS50]

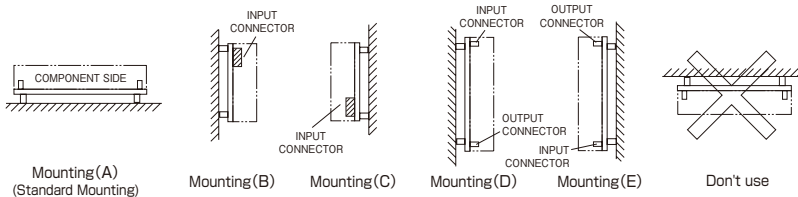
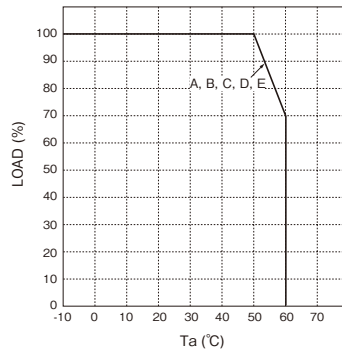

Recommended standard mounting method is (A).
The output derating may vary due to mounting method and ambient temperature. Please use within the range of derating above.
In the derating curve, maximum output current or maximum output power in specification refers 100%.
Please do not use (F), where the PCB will be on the top side and heat will be trapped inside the unit.

[ZWS300]

Convection Cooling
Output Derating Curve

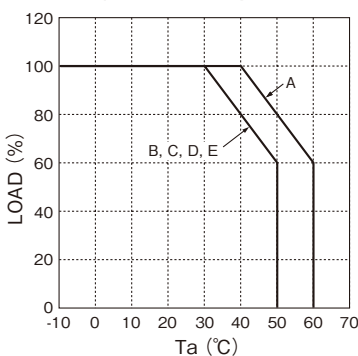

Forced Air Cooling
Output Derating Curve

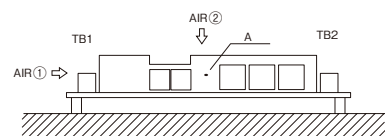
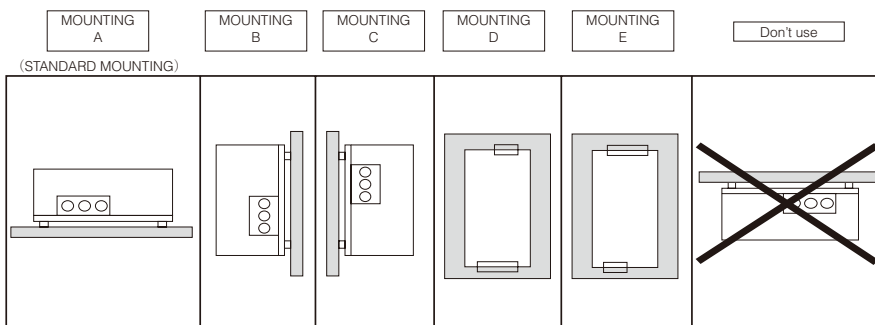
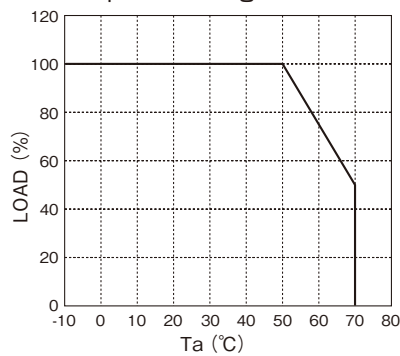

*Please make air flow to maintain the heat sink (part A) temperature 85°C or less (Operating ambient temperature is 50°C).
The air flow direction is Air ① or Air ② indicated in the above figure.

Block Diagram

[ZWS5, ZWS10, ZWS15, ZWS30]

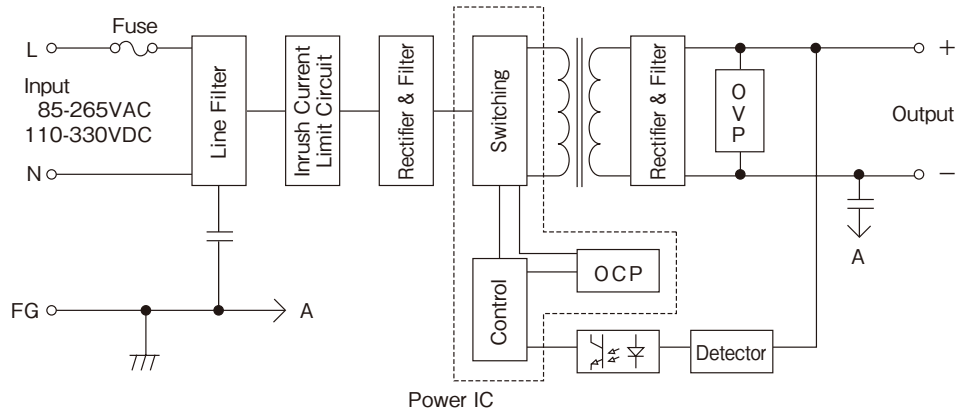

●Circuit mode and switching frequency
Switching circuit : Flyback topology (ON/OFF) 100kHz (Fixed)

●Fuse rating... ZWS5,10,15 : 2A, ZWS30 : 3.15A

[ZWS50]

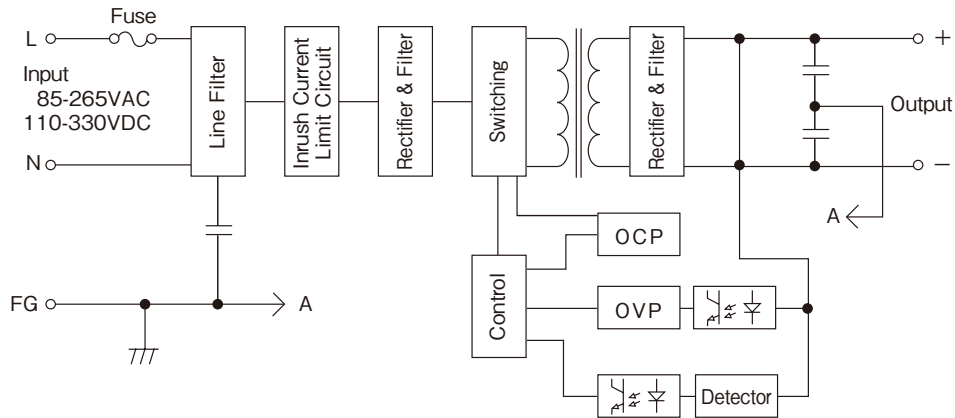

●Circuit mode and switching frequency
Switching circuit : Single-ended forward topology (ON/OFF) 105kHz (Fixed)

●Fuse rating... 3.15A

[ZWS300]

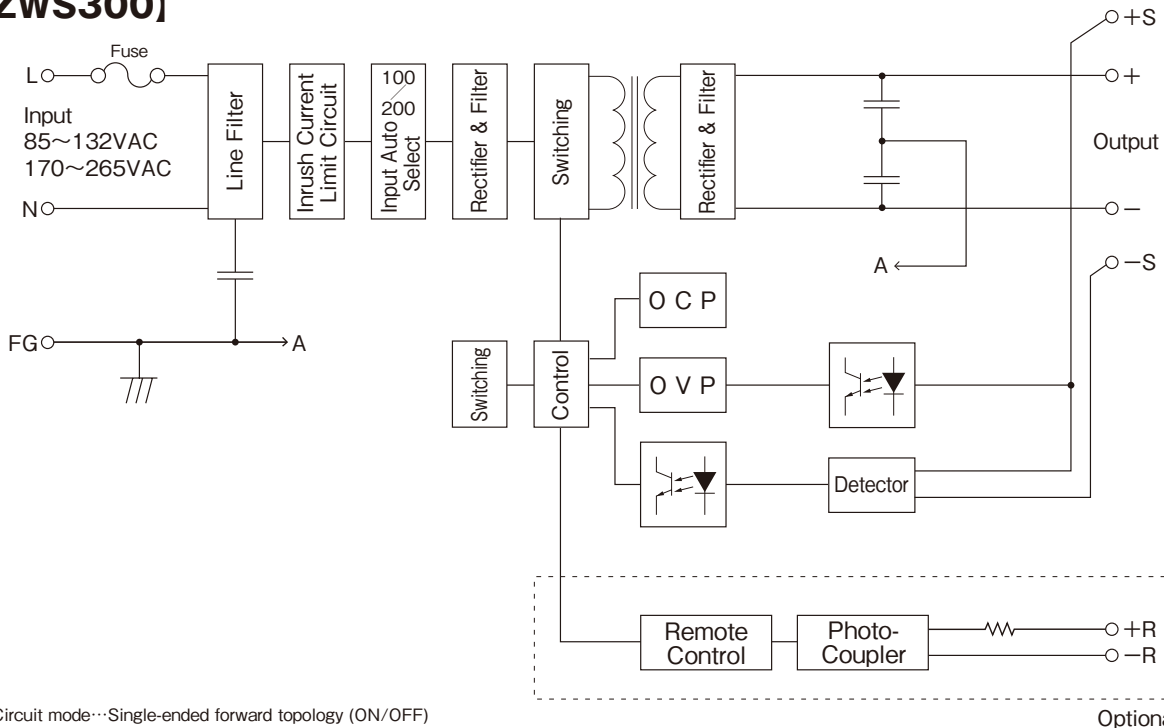

●Circuit mode...Single-ended forward topology (ON/OFF)
●Switching frequency...140kHz (Fixed)

Optional

[ZWS50AF, ZWS75AF, ZWS100AF, ZWS150AF]

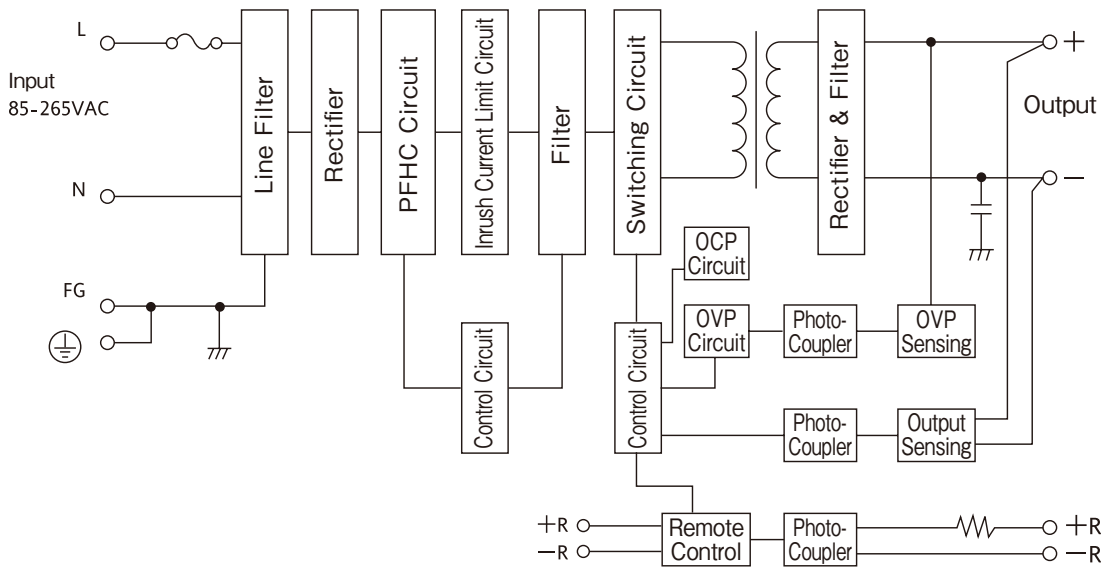

- Circuit mode and switching frequency
Switching circuit : Single - ended forward topology
(ZWS50AF, 100AF, 150AF : 130kHz, ZWS75AF : 120kHz)
PFHC circuit : Active Filter (90kHz)
- Fuse rating : ZWS50AF : 2A, ZWS75AF : 3.15A
ZWS100AF : 3.15A, ZWS150AF : 5A

Circuit for Measuring Performances

[ZWS5 - 50]

- ℓ : 150mm
- Wire material: AWG#22 (ZWS5 - ZWS15)
AWG#18 (ZWS30 - ZWS150PF)
- C1: Electrolytic capacitor 100μF
- C2: Film capacitor 0.1μF (1μF for ZWS15 - ZWS50)

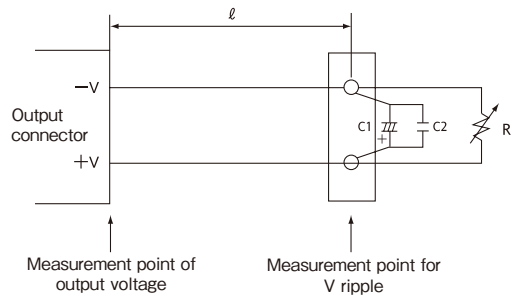

[ZWS50AF - 150AF]

- ℓ : 150mm
- Wire material: AWG#18
- C1: Electrolytic capacitor 100μF
- C2: Film capacitor 0.1μF

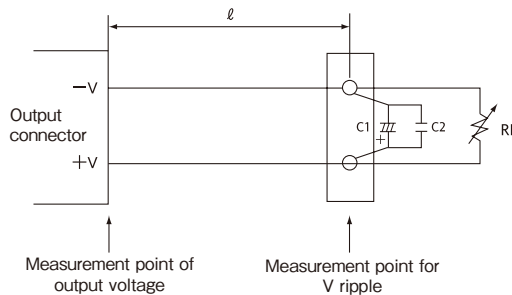

ZWS5-50 Instruction Manual

● ZWS50AF - ZWS150AF Instruction Manual  A-433

● ZWS300 Instruction Manual  A-441

BEFORE USING THE POWER SUPPLY UNIT

Pay attention to all cautions and warnings before using the unit. Incorrect usage could lead to an electric shock, damage to the unit or a fire hazard.

- Ensure the wiring to input terminal is connected correctly according to this instruction manual.
- This is PC board type power supply. Please hold on the board side while mounting, and don't touch the component side. In using for the apparatus, please lift the power supply with a spacer.

 **WARNING**

- Do not touch the internal components, they may have high voltage or high temperature. You may get electric shock or burned.
- When the unit is operating, keep your hands and face away from it, you may get injured by an accident.

 **CAUTION**

- This power supply is primarily designed and manufactured

to be used and enclosed in other equipment. Stick the WARNING label for users on the system equipment and describe the notice in the instruction manual.

- Never operate the unit under over current or shorted condition for 30 seconds or more which could result in damage or insulation failure. There is no possibility for fire or burning.
- This power supply has a possibility that hazardous voltage may occur in output terminal depending on failure mode. The outputs of these products must be earthed in the end use equipment to maintain SELV. If the outputs are not earthed, they must be considered hazardous and must not be made user accessible.

Note : CE MARKING

CE Marking, when applied to a product covered by this handbook, indicates compliance with the low voltage directive (73/23/EEC) as modified by the CE Marking Directive (93/68/EEC) which complies with EN60950.

1. Specifications

1 Input Voltage Range

85 - 265 VAC (47 - 440 Hz) or 110 - 330 VDC

2 Operating Temperature

-10°C to +50°C: 100% load,
+60°C: 70% load (Convection Cooling)

4 Input Current (Typ) [A]

INPUT \ MODEL	ZWS5	ZWS10	ZWS15	ZWS30	ZWS50
100VAC	0.14	0.30	0.45	0.83	1.4
200VAC	0.07	0.15	0.23	0.42	0.7

3 Safety Standards

Approved by UL60950-1, CSA C22.2 No.60950-1, EN60950-1.
Built to meet DENAN.

5 Nominal Output Voltage [V] and Maximum Output Current [A]

MODEL \ OUTPUT	3.3	5	12	15	24	36	48
ZWS5	1.0	1.0	0.42	0.34	0.22	—	—
ZWS10	2.0	2.0	0.85	0.70	0.45	—	—
ZWS15	3.0	3.0	1.25	1.00	0.65	—	—
ZWS30	6.0	6.0	2.50	2.00	1.30	0.90	0.70
ZWS50	10.0	10.0	4.30	3.50	2.10	1.40	1.10

2. Explanation on Terminals

- Input must be off when making connections.
- ZWS5-15: 3A for each pin of output connector
ZWS30: 5A for each pin of output connector
- Connect FG terminal of input connector and mountale FG to ground terminal of the equipment.

- Use the input/output connector housing, terminal pin as specified in outline drawing. Connector housing and terminal pin are not included with this product. Also, use recommended crimping tool.

ZWS

ZWS5

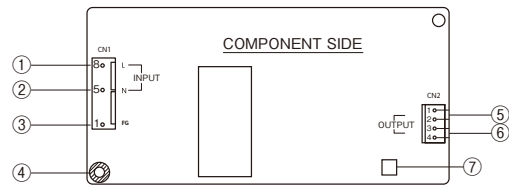

- (/J models)
(pin 1 of CN1)
- ① Input terminal (pin 8 of CN 1)
L: Live line with a fuse inside
- ② Input terminal (pin 5 of CN 1) (pin 3 of CN1)
N: Neutral line
- ③ Input terminal (pin 1 of CN 1) (pin 5 of CN1)
FG: Frame Ground
- ④ Frame Ground (FG)
Connected to pin 1 of CN 1
Please ground to the apparatus with a spacer of conductive material. (The mounting surface of the spacer should be within MAXφ8.)
- ⑤ +Output terminal (pin 1, 2 of CN2) (pin 3, 4 of CN2)
- ⑥ -Output terminal (pin 3, 4 of CN2) (pin 1, 2 of CN2)
- ⑦ Output voltage adjustment trimmer (Turning the trimmer clockwise increases the output voltage.)
- * Standard models are designed for MOLEX connectors. Optional model with "/J" are designed for JST connectors.
 - * MOLEX connectors are easy to procure in countries other than Japan.
 - * When manufacturing in Japan, please use "/J" models for JST connectors.

ZWS10

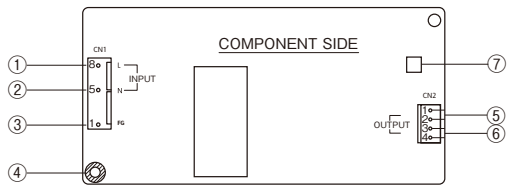

- (/J models)
(pin 1 of CN1)
- ① Input terminal (pin 8 of CN1)
L: Live line with a fuse inside
- ② Input terminal (pin 5 of CN1) (pin 3 of CN1)
N: Neutral line
- ③ Input terminal (pin 1 of CN1) (pin 5 of CN1)
FG: Frame Ground
- ④ Frame Ground (FG)
Connected to pin 1 of CN1
Please ground to the apparatus with a spacer of conductive material. (The mounting surface of the spacer should be within MAXφ8.)
- ⑤ +Output terminal (pin 1, 2 of CN2) (pin 3, 4 of CN2)
- ⑥ -Output terminal (pin 3, 4 of CN2) (pin 1, 2 of CN2)
- ⑦ Output voltage adjustment trimmer (Turning the trimmer clockwise increases the output voltage.)
- * Standard models are designed for MOLEX connectors. Optional model with "/J" are designed for JST connectors.
 - * MOLEX connectors are easy to procure in countries other than Japan.
 - * When manufacturing in Japan, please use "/J" models for JST connectors.

ZWS15

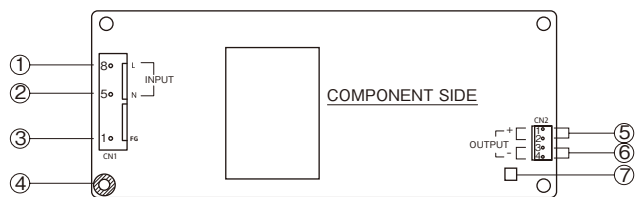

- (/J models)
(pin 1 of CN1)
- ① Input terminal (pin 8 of CN1)
L: Live line with a fuse inside
- ② Input terminal (pin 5 of CN1) (pin 3 of CN1)
N: Neutral line
- ③ Input terminal (pin 1 of CN1) (pin 5 of CN1)
FG: Frame Ground
- ④ Frame Gound (FG)
Connected to pin 1 of CN1
Please ground to the apparatus with a spacer of conductive material.
(The mounting surface of the spacer should be within MAXφ8.)
- ⑤ +Output terminal (pin 1, 2 of CN2) (pin 3, 4 of CN2)
- ⑥ -Output terminal (pin 3, 4 of CN2) (pin 1, 2 of CN2)
- ⑦ Output voltage adjustment trimmer (Turning the trimmer clockwise increases the output voltage.)
- * Standard models are designed for MOLEX connectors. Optional model with "/J" are designed for JST connectors.
 - * MOLEX connectors are easy to procure in countries other than Japan.
 - * When manufacturing in Japan, please use "/J" models for JST connectors.

ZWS30

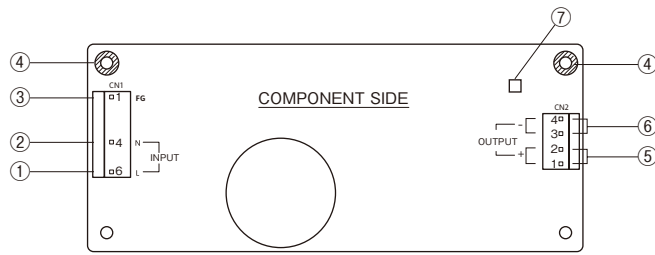

- ① Input terminal (pin 6 of CN1) (/J models)
L: Live line with a fuse inside (pin 1 of CN1)
- ② Input terminal (pin 4 of CN1) (pin 3 of CN1)
N: Neutral line
- ③ Input terminal (pin 1 of CN1) (pin 5 of CN1)
FG: Frame Ground
- ④ Frame Ground (FG)
Connected to pin 1 of CN1
Please ground to the apparatus with a spacer of conductive material.
(The mounting surface of the spacer should be within MAXφ8.)
- ⑤ +Output terminal (pin 3, 4 of CN2) (pin 3, 4 of CN2)
- ⑥ -Output terminal (pin 1, 2 of CN2) (pin 1, 2 of CN2)
- ⑦ Output voltage adjustment trimmer (Turning the trimmer clockwise increases the output voltage.)
* Standard models are designed for MOLEX connectors.
Optional model with "/J" are designed for JST connectors.

ZWS50

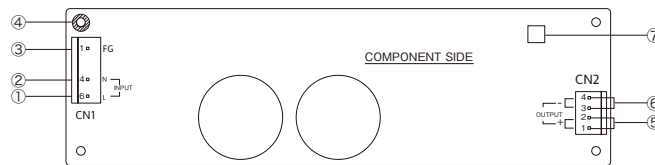

- ① Input terminal (pin 6 of CN 1) (/J models)
L: Live line with a fuse inside (pin 1 of CN1)
- ② Input terminal (pin 4 of CN 1) (pin 3 of CN1)
N: Neutral line
- ③ Input terminal (pin 1 of CN 1) (pin 5 of CN1)
FG: Frame Ground
- ④ Frame Ground (FG)
connected to pin 1 of CN 1
Please ground to the apparatus with a spacer of conductive material.
(The mounting surface of the spacer should be within MAXφ8.)
- ⑤ +Output terminal (pin 3, 4 of CN 2) (pin 3, 4 of CN2)
- ⑥ -Output terminal (pin 1, 2 of CN 2) (pin 1, 2 of CN2)
- ⑦ Output voltage adjustment trimmer (Turning the trimmer clockwise increases the output voltage.)
* Standard models are designed for MOLEX connectors.
Optional model with "/J" are designed for JST connectors.

3. Terminal Connection

● Pay attention to the input wiring. If it is connected with wrong terminal, the power supply will be damaged.

ZWS5

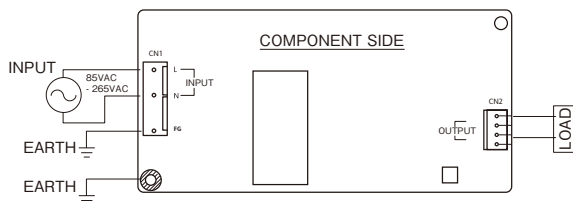

- Please use the following housings & pins to connect the input terminal. Connectors in use (Molex made)
Input side CN1: 6373-A8A (102) 52
Output side CN2: 6373-A04A-102
Matching housings & pins (not included with the product) (Molex made)
Input socket housing (use for CN1) : 40136A-D08 1 piece
Output socket housing (use for CN2) : 40136A-D04 1 piece
Terminal pin (use for CN1, 2) : 7879-2-P912 7 pieces
Pressing Tools (Molex made) Hand Crimping Tool : 11-01-0037

ZWS10

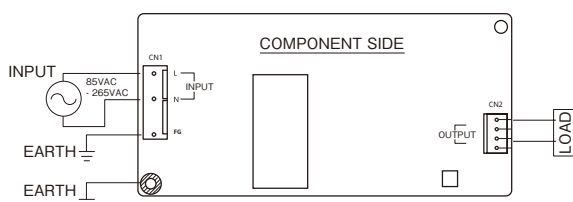

- Please use the following housings & pins to connect the input terminal. Connectors in use (Molex made)
Input side CN1: 6373-A8A (102) 52
Output side CN2: 6373-A04A-102
Matching housings & pins (Not included with the product) (Molex made)
Input socket housing (use for CN1) : 40136A-D08 1 piece
Output socket housing (use for CN2) : 40136A-D04 1 piece
Terminal pin (use for CN1, 2) : 7879-2-P912 7 pieces
Pressing Tools (Molex made) Hand Crimping Tool : 11-01-0037



ZWS15

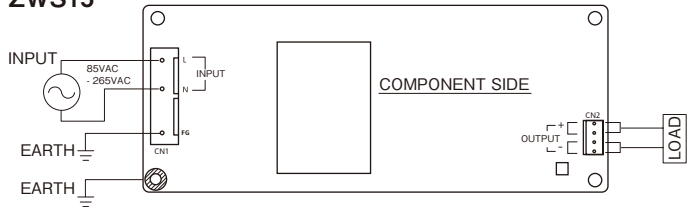

- Please use the following housings & pins to connect the input terminal. Connectors in use (Molex made)
 Input side CN1: 6373-A8A (102) 52
 Output side CN2: 6373-A04A-102
 Matching housings & pins (Not included with the product) (Molex made)
 Input socket housing (use for CN1):
 40136A-D08 1 piece
 Output socket housing (use for CN2):
 40136A-D04 1 piece
 Terminal pin (use for CN1,2):
 7879-2-P912 7 pieces
 Pressing Tools (Molex made) Hand Crimping Tool:
 11-01-0037

ZWS30

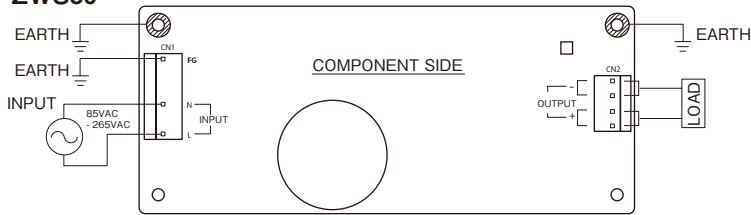

- The output current on one terminal is limited to 5A. If the necessary current is more, please use the terminals together appropriately.
- Please use the following housings & pins to connect the input terminal. Connectors in use (Molex made)
 Input side CN1: 5414-30B
 Output side CN2: 5273-04A
 Matching housings & pins (Not included with the product) (Molex made)
 Input socket housing (use for CN1):
 5239-06 1 piece
 Output socket housing (use for CN2):
 5239-04 1 piece
 Terminal pin (use for CN1,2):
 5167 PBTL 7 pieces
 Pressing Tools (Molex made) Hand Crimping Tool:
 JHTR24454

ZWS50

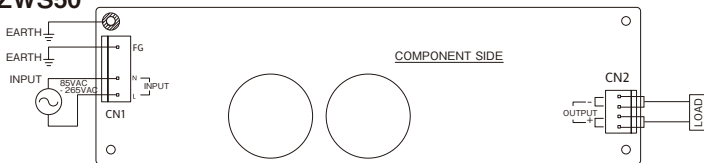

- The output current on one terminal is limited to 5A. If the necessary current is more, please use the terminals together appropriately.
- Please use the following housings & pins to connect the input terminal. Connectors in use (Molex made)
 Input side CN1: 5414-30B
 Output side CN2: 5273-04A
 Matching housings & pins (Not included with the product) (Molex made)
 Input socket housing (use for CN1):
 5239-06 1 piece
 Output socket housing (use for CN2):
 5239-04 1 piece
 Terminal pin (use for CN1,2):
 5167 PBTL 7 pieces
 Pressing Tools (Molex made) Hand Crimping Tool:
 JHTR24454

4. Functions and Cautions

1 Over Voltage Protection (OVP)

ZWS5 - ZWS30:

These models are provided by zener-clamp method. If the output voltage is shutdown by the overvoltage protection (between 140 - 210% of output voltage), the zener diode must be replaced in order for the output to recover.

ZWS50:

This model is provided with a built-in, handy reset OVP circuit of output shutdown method. The output will be down when the output voltage is up to 115 - 135% of the rated. Once OVP circuit shut the output down, the output can only be recovered by turning off the input line and re-

input the power after interval time. The value of OVP is fixed.

2 Over Current Protection (OCP)

ZWS Series are provided with a built-in primary side OCP circuit with automatic recovery. OCP is workable when the load is over 125% of the rated. The power supply will automatically recover when the overload or short conditions are cleared. Please do not let the unit work under overload or short conditions over 30 seconds, or the power supply is feared to be damaged.

3 Ripple

The rated maximum ripple value is the test result measuring by the instructed ripple measuring circuit, using JEITA probe or other equivalent. If the load cable is too long, please connect a capacitor (electrolytic, film, etc) to the load terminals to reduce the ripple on the load terminal.

4 In-Rush Current

ZWS Series are provided with a built-in inrush current protecting circuit. ZWS5-ZWS50 are limited by method using Power Thermistor. The limit current changes depending on the temperature, it is large at high temperature or while re-input after period of operation. Be care to select the switch and the outside fuse.

5 Output Voltage Range

V.ADJ trimmer on PCB can adjust the output volume. Output voltage range is within ±10 % of nominal output voltage. To turn the trimmer clockwise, the output voltage will be increased. Note that over voltage protection (OVP) function may trigger if the output voltage is increased excessively.

6 Peak Output Current

Output current can cope with peak current loads. Specified maximum output current and peak output current must satisfy formulas below.

Allowable peak output operating duration is less than 10 sec. Cycle should be more than 10ms and duty should be ≤ 0.35.

$$(\tau \leq 10 \text{ seconds})$$

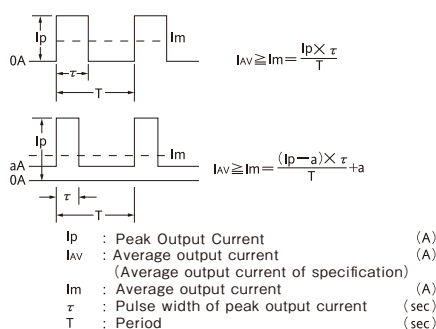

7 Series Operataion

For series operation, either (A) or (B) is possible. Please use the output current value less than maximum output current of the series-connected power supply of whichever the maimum output current is smaller.

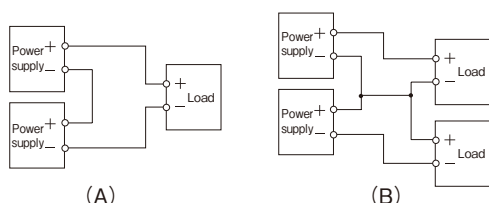

8 Parallel Operation

(A) To increase the output current is not possible.

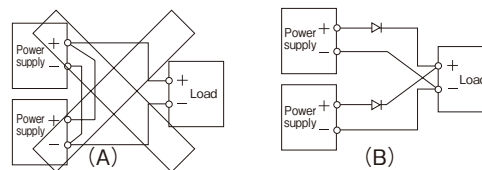

(B) To use as back-up power supply

1. Set power supply output voltage higher by the forward voltage drop (V_F) of diode.
2. Adjust the output voltage of each power supply to be the same.
3. Use within the specifications for output voltage and output power.

9 Insulation Resistance Test

The insulation resistance value is above 100MΩ at 500VDC.

Considering the safety, please set the voltage value of DC insulation meter before the test, and well discharge the insulation meter after the test.

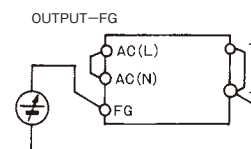

10 Withstand Voltage Test

ZWS series are designed to be able to withstand 3KVAC (20mA) 1minute between input-output, 2KVAC (20mA) 1minute between input-FG, and 500VAC (100mA) 1 minute between output-FG.

Please set the limit current value of the withstand voltage tester as mentioned above before doing test.

Please elevate the applying voltage gradually, and lower it gradually, too, when shutdown.

Please do not use a timer in the test. Because when the test voltage is supplied or shut down, an impulse high voltage may be generated which will break the power supply unit.

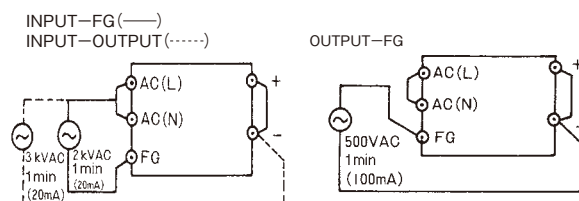

5. Mounting

Please use the mounting hole as:

ZWS5, ZWS10: 2 holes of $\phi 3.5$

ZWS15 - ZWS50: 4 holes of $\phi 3.5$

and insert the spacer (MAX $\phi 8$) of height over 8mm to lift the unit. The vibration spec. is the value taken when the unit is raised by 8mm spacers.

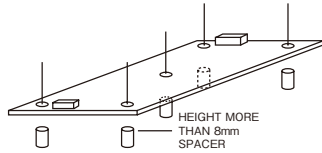

- * Please fix all the five mounting holes with screws.
- Please note that the PCB pattern might be damaged when less than four mounting holes are fixed.

Please leave 4mm space from the surfaces and the sides of PCB, especially from the solder surface, 8mm space is

necessary. If the space is not enough, the specification of insulation and withstand will not be satisfied.

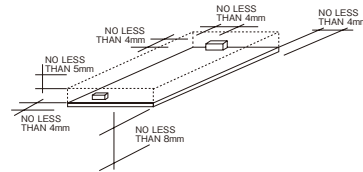

FG should be connected to the earth terminal of the apparatus. If not, the conducted noise and output noise will increase.

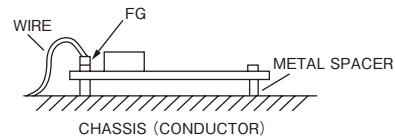

6. Wiring

In order to improve the noise property, please set the input wire far from the output wire, and twist the wires. It is effective to clear the noise by connecting a small capacitor on the output terminal. Please select the wire materials to adapt the connector as follows.

- Input: ZWS5 - ZWS15: AWG#30 - #22
- ZWS30, ZWS50: AWG#22 - #18
- Output: ZWS5 - ZWS15: AWG#30 - #22
- ZWS30, ZWS50: AWG#22 - #18

7. External Fuse Rated Current

When using an outside fuse, please select the fuse capacity as follows. Moreover, please do not use the fast blow fuse. Refer to the following fuse rating when selecting the external fuses that are to be used on input line. Surge current flows when line turns on. Do not select the fuse according to input current (RMS) values under the actual load condition.

Rated Current of Fuse

Model No.	Rated Current of Fuse
ZWS5	2A
ZWS10	2A
ZWS15	2A
ZWS30	3.15A
ZWS50	3.15A

8. Check Before Thinking of Trouble

- Check the rated input voltage is connected.
- Check the wiring of input and output is correct.
- Ensure the input and output connectors are completely inserted, and the pressing of the connector pins are exactly fixed.
- Check the wire material is not too thin.

Model	Maximum capacitance					
	3.3V	5V	12V	15V	24V	36V 48V
ZWS5, ZWS10, ZWS15	5,000uF		10,000uF		—	—
ZWS30, ZWS50	10,000uF					

9. Repair

In case of damage or repair of this product, please return to our service center or factory.

ZWS-AF Series Instruction Manual

BEFORE USING THE POWER SUPPLY UNIT

Pay attention to all warnings and cautions before using the unit. Incorrect usage could lead to an electric shock, damage to the unit or a fire hazard.

⚠ WARNING and CAUTION

- Do not touch the internal components, they may have high voltage or high temperature. You may get electric shock or burned.
- When the unit is operating, keep your hands and face away from it, you may get injured by an accident.
- This power supply is primarily designed and manufactured to be used and enclosed in other equipment.
- Do not operate overload or dead short condition for more than 30 seconds which could result in damage or insulation failure. There is no possibility for fire or burning.
- Confirm connections to input/output terminals are correct as indicated in the instruction manual.
- This power supply is PC board type unit. PCB stress such

as bending, twisting could cause damage. Therefore, please handle with care.

- When handling, hold the board edge and take care not to touch component side. When mounting power supply unit on apparatus or equipment, lift the power supply with spacer.
- Do not drop or apply shock to power supply unit.
- This power supply has a possibility that hazardous voltage may occur in output terminal depending on failure mode. The outputs of these products must be earthed in the end use equipment to maintain SELV. If the outputs are not earthed, they must be considered hazardous and must not be made user accessible.

Note : CE MARKING

CE Marking, when applied to a product covered by this handbook, indicates compliance with the low voltage directive (73/23/EEC) as modified by the CE Marking Directive (93/68/EEC) which complies with EN60950.

1. Terminal Explanation

ZWS50AF

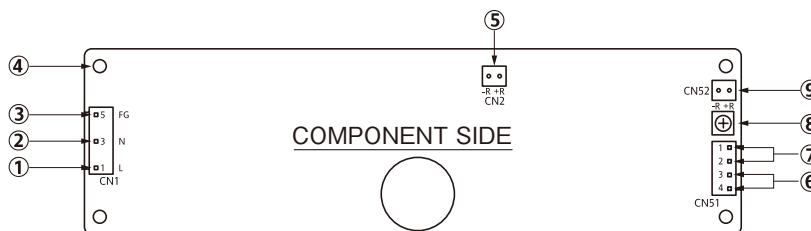

ZWS75AF

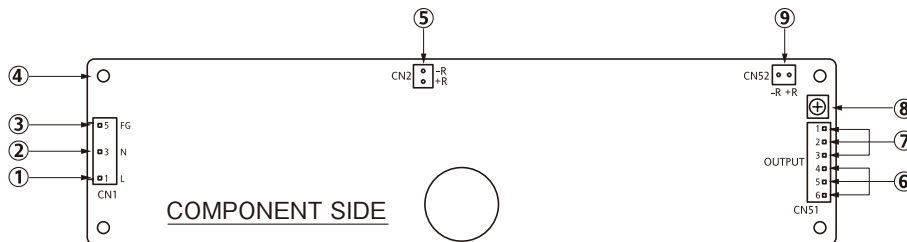

ZWS100AF

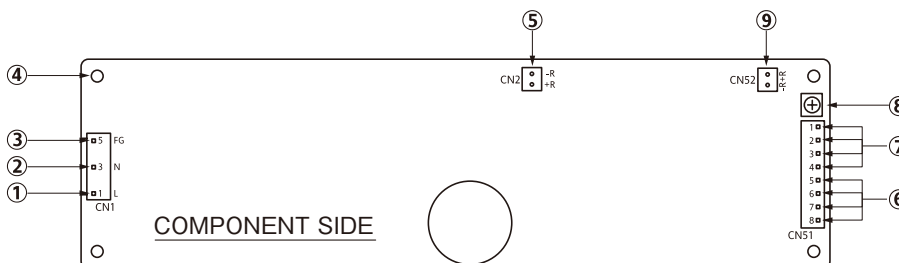

ZWS150AF

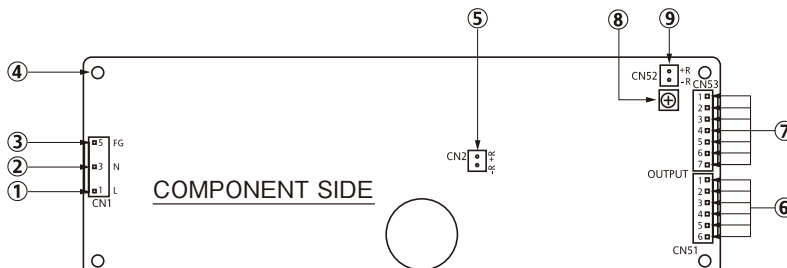

ZWS

- ① L: AC input terminal (pin 6 of CN1)
Live line (fuse in line)
- ② N: AC input terminal (pin 4 of CN1)
Neutral line
- ③ FG: Input terminal FG (pin 1 of CN1)
Safety earth (Frame Ground)
Connect to safety ground of apparatus or equipment.
- ④ FG: Frame Ground (Connected to pin 1 of CN1)
Must be connected to electrically safe ground of apparatus or equipment by electrically conductive spacers.
The mounting surface of the spacer should be within MAX 8mm.
- ⑤ CN2: ON/OFF control terminal (primary circuit)
See NOTE A.
- ⑥ +: + Output terminal
- ⑦ -: - Output terminal
- ⑧ V.ADJ: Output voltage rises when a trimmer is turned clockwise.
- ⑨ CN52: ON/OFF control terminal (secondary circuit)
(For power supply output on and off control with an external signal.)
See NOTE A.

NOTE A : For COVER & CHASSIS TYPE (MODEL : ZWS-AF/JA) . remote ON/OFF control cannot be used.

2. Terminal Connection Method

Pay attention to the input wiring. If it is connected to wrong terminal, the power supply will be damaged.

- Input must be off when making connection.
- Connect FG terminal to ground terminal of the equipment.
- Output current of each terminal pin must be less than 5A.
- The output load line and input line shall be separated and twisted to improve noise sensitivity.

- Remote ON/OFF control line shall be twisted or use shielded wire.
- When connecting or removing connector, do not apply stress to PCB.
- Use the input/output connector specified in outline drawing.
Connector is not included with this product.

ZWS50AF

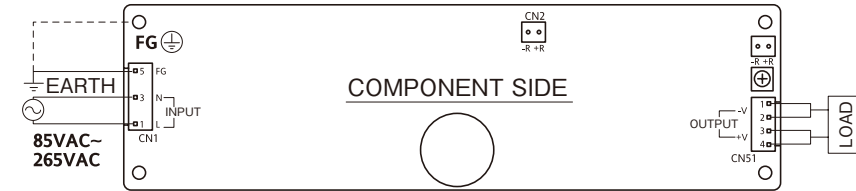

ZWS75AF

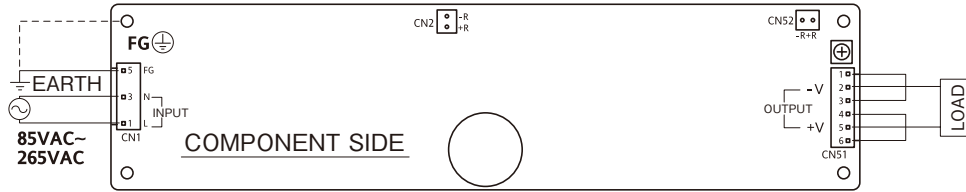

ZWS100AF

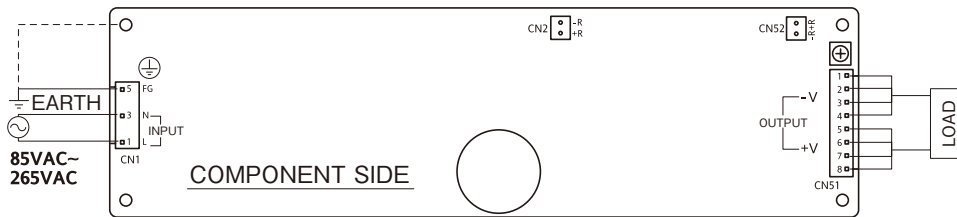

ZWS150AF

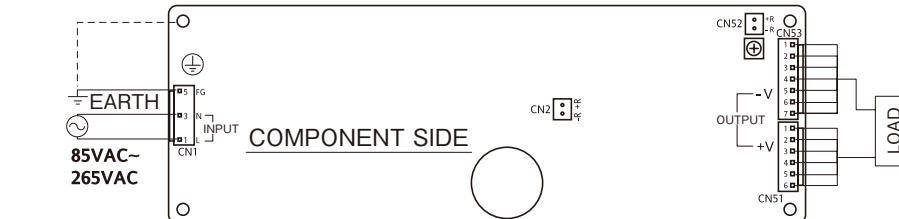

* Connector for Remote ON/OFF Control : CN2, CN52 (J.S.T)

Connector	Housing	Terminal Pin
B2B-XH-AM	XHP-2	BXH-001T-P0.6 or SXH-001T-P0.6

CN2 is normally shorted by JM-2W-96(J.S.T).

Hand Crimping Tool : YC-110R(J.S.T) or YRS-110(J.S.T)

* Input & Output Connector (MOLEX)

	ZXWS50AF			ZWS75AF		
	Connector	Housing	Terminal Pin	Connector	Housing	Terminal Pin
Input : CN1 Output : CN51	5414-30B	5239-06	5167PBTL	5414-30B	5239-06	5167PBTL
	5273-04A	5239-04	5167PBTL	5273-06A	5239-06	5167PBTL

	ZWS100AF			ZWS150AF		
	Connector	Housing	Terminal Pin	Connector	Housing	Terminal Pin
Input : CN1	5414-30B	5239-06	5167PBTL	5414-30B	5239-06	5167PBTL
Output : CN51 CN53	5273-08A	5239-08	5167PBTL	5273-06A	5239-06	5167PBTL
				5273-07A	5239-07	5167PBTL

CN53 is used only for ZWS150AF.

Hand Crimping Tool : JHTR2445A (MOLEX)

* ZWS-AF/J Input & Output Connector (J.S.T)

	ZWS50AF/J			ZWS75AF/J		
	Connector	Housing	Terminal Pin	Connector	Housing	Terminal Pin
Input : CN1 Output : CN51	B3P-5-VH	VHR-5N	SVH-21T-P1.1	B3P-5-VH	VHR-5N	SVH-21T-P1.1
	B4P-VH	VHR-4N	SVH-21T-P1.1	B6P-VH	VHR-6N	SVH-21T-P1.1

	ZWS100AF/J			ZWS150AF/J		
	Connector	Housing	Terminal Pin	Connector	Housing	Terminal Pin
Input : CN51	B3P-5-VH	VHR-5N	SVH-21T-P1.1	B3P-5-VH	VHR-5N	SVH-21T-P1.1
Output : CN51 CN53	B8P-VH	VHR-8N	SVH-21T-P1.1	B6P-VH	VHR-6N	SVH-21T-P1.1
				B7P-VH	VHR-7N	SVH-21T-P1.1

CN53 is used only for ZWS150AF.

Hand Crimping Tool : YC-160R(J.S.T)

Pin-order of J.S.T connectors are opposite to pin-order of MOLEX. Please refer to outline drawing.

3. Explanation of Functions and Precautions

1 Input Voltage Range

Input voltage range is single phase 85-265VAC (47-63Hz) or 120-370VDC. Input voltage which is out of specification may cause unit damage. For cases where conformance to various safety specs (UL, CSA, EN) are required, input voltage range will be 100-240VAC (50/60Hz).

2 Output Voltage Range

V.ADJ trimmer (VR51) near output connector can adjust the output voltage within the range. Output voltage range is within $\pm 10\%$ of nominal output voltage. To turn the trimmer clockwise, the output voltage will be increased. Note over voltage protection (OVP) function may trigger if the output voltage is increased excessively.

3 Inrush Current

This series has used Power Thermistor to protect the circuit from inrush current. Please carefully select input switch and fuse in cases of the high temperature and re-input the power.

4 Over Voltage Protection (OVP)

The OVP function (inverter shut down method, manual

reset type) is provided. OVP function operates within 115-135% (5V type: 115-140%) of nominal output voltage. When OVP triggers, the output will be shut down. The input shall be removed for a few minutes, and then re-input for recovery of the output. OVP setting shall be fixed and not to be adjusted externally.

5 Over Current Protection (OCP)

Constant current limiting, automatic recovery. OCP function operates when the output current exceeds 125% (5V type: 105%) of maximum output current of specification. The output will be automatically recovered when the overload condition is canceled. Do not operate overload or dead short conditions for more than 30 seconds, which could result in damage.

6 Output Ripple & Noise

The standard specification for maximum ripple value is measured according to measurement circuit specified by JEITA-RC9131. When load lines are longer, ripple becomes larger. In this case, electrolytic capacitor, film capacitor, etc., might be necessary to use across the load terminal. The output ripple cannot be measured accurately if the probe ground lead of oscilloscope is too long.

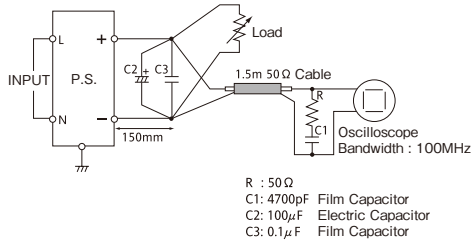

7 Series Operation

For series operation, either method (A) or (B) is possible.

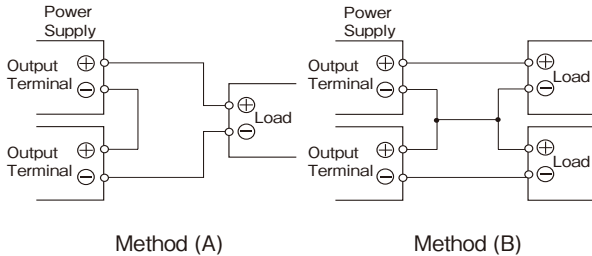

8 Parallel Operation

(A) To increase the output current is not possible.

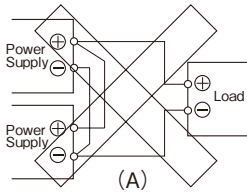

(B) To use as back-up power supply

1. Set power supply output voltage higher by the forward voltage drop (V_F) of diode.
2. Adjust the output voltage of each power supply to be the same.
3. Use within the specifications for output voltage and output power.

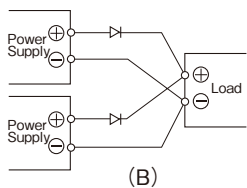

9 Peak Output Current

For ZWS-AF series, relation with average output current and peak output current must satisfy formulas below. Also operating time at peak output is less than 10sec. When using pulse load, audible noise can be heard from power supply unit.

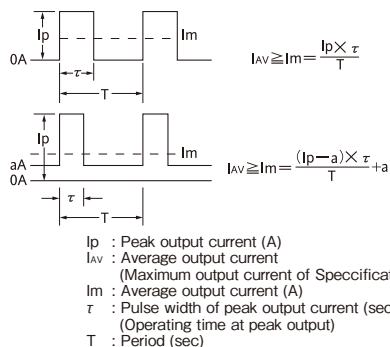

10 Remote ON/OFF Control

Remote ON/OFF control (CN2, CN52) function is available. Using this function allows the user to turn the output on and off without having to turn the AC input on and off. Remote ON/OFF control can be used by following 2 modes.

However, for Cover & Chassis type (MODEL: ZWS-AF/JA), can not be used.

*** Using CN2**

It is controlled by short or open between +R & -R of CN2. CN2 is provided in the primary circuit for ON/OFF control by means of a switch or other device. When using this connector, which is considered to be electrically connected to the mains input voltage, all the requirements of EN60950 must be met with respect to the connector. wiring and switch etc.

In particular :

- 1) Basic insulation must be provided between the ON/OFF control circuit and earth.
- 2) Reinforced insulation must be provided between the ON/OFF control circuit and any secondary circuit or accessible part.
- 3) Wiring must be routed such that damage to the insulation of the wire or additional sleeving cannot occur.
- 4) The switch must meet requirements for reinforced insulation from the ON/OFF control circuit to actuator/accessible parts.

[CN2] The control mode is shown below.

+R & -R terminal condition	Output Condition
SHORT	ON
OPEN	OFF

*** Using CN52**

At first, remove short piece of CN2.

It is controlled by the voltage applied to +R and -R. This circuit is in the secondary (output) side of the power supply unit. Do not connect in the primary (input) side. And this circuit is isolated from the output by a photo-coupler.

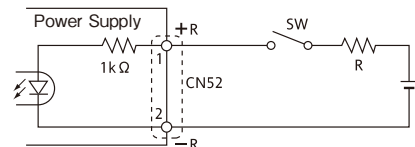

[CN52] The control mode is shown below.

+R & -R terminal condition	Output Condition
SW ON (Higher than 4.5V)	ON
SW OFF (Lower than 0.8V)	OFF

External voltage level : E	External resistance : R
4.5 - 12.5VDC	No required
12.5 - 24.5VDC	1.5 kΩ

11 Isolation Test

Isolation resistance between output and FG (chassis) shall be more than 100MΩ at 500VDC. For safety operation, voltage setting of DC isolation tester must be done before the test. Ensure that it is fully discharged after the test

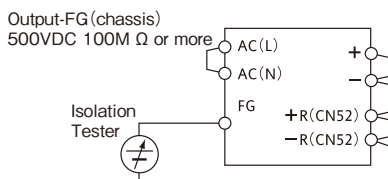

12 Withstand Voltage

This series is designed to withstand 3.0kVAC between input and output, 2.0kVAC between input and FG (chassis), and 500VAC between output and FG (chassis), each for

1 minute.

When testing withstand voltage, set current limit of withstand voltage test equipment at 20mA (Output-FG (chassis): 100mA). The applied voltage must be gradually increased from zero to testing value and then gradually decreased for shut down. When timer is used, the power supply may be damaged by high impulse voltage at timer switch on and off. Connect input and output as follows.

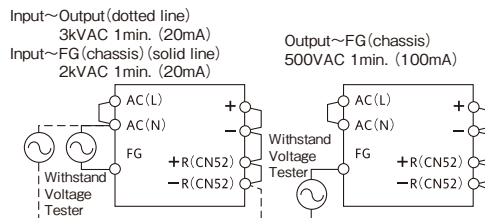

4. Mounting Directions

1 Output Derating according to the Mounting Directions

Recommended standard mounting method is (A). Method (B), (C), (D), (E), and (F) are also possible. Refer to the derating below. In the following derating curve, the average output current is considered to be 100%.

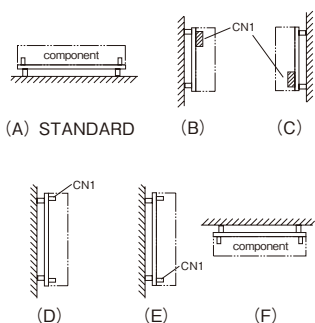

ZWS75AF

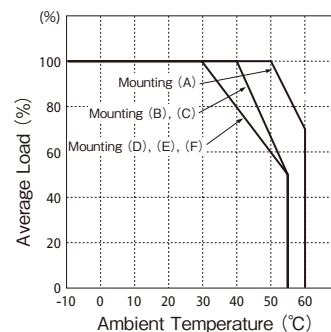

ZWS75AF Output Derating

Mounting Ta	LOAD (%)					
	A	B	C	D	E	F
-10 to +30°C	100	100	100	100	100	100
+40°C	100	100	100	80	80	80
+50°C	100	66	66	60	60	60
+55°C	85	50	50	50	50	50
+60°C	70	-	-	-	-	-

Output Derating (Convection Cooling)

ZWS50AF

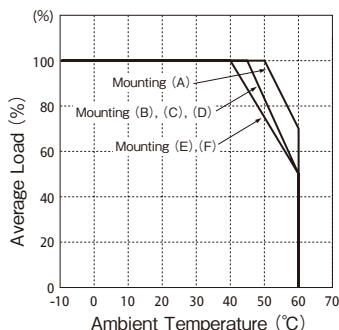

ZWS50AF Output Derating

Mounting Ta	LOAD (%)					
	A	B	C	D	E	F
-10 to +40°C	100	100	100	100	100	100
+45°C	100	100	100	100	88	88
+50°C	100	83	83	83	75	75
+55°C	85	66	66	66	62	62
+60°C	70	50	50	50	50	50

ZWS100AF

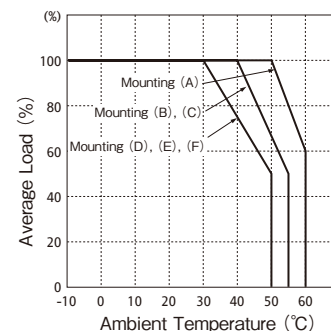

ZWS100AF Output Derating

Mounting Ta	LOAD (%)					
	A	B	C	D	E	F
-10 to +30°C	100	100	100	100	100	100
+40°C	100	100	100	75	75	75
+50°C	100	68	68	50	50	50
+55°C	80	50	50	-	-	-
+60°C	60	-	-	-	-	-

• All specifications are subject to change without notice.

ZWS150AF

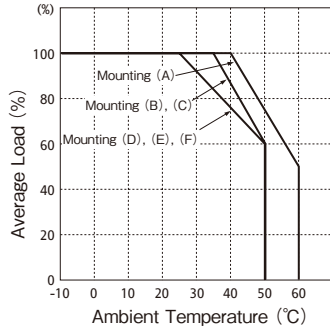

ZWS150AF

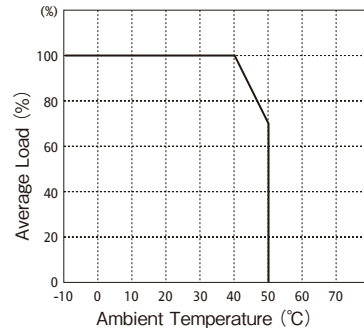

ZWS150AF Output Derating

Mounting Ta	LOAD (%)					
	A	B	C	D	E	F
-10 to +25°C	100	100	100	100	100	100
+35°C	100	100	100	84	84	84
+40°C	100	88	88	76	76	76
+50°C	75	60	60	60	60	60
+60°C	50	-	-	-	-	-

ZWS150AF Output Derating

Mounting Ta	LOAD (%)
	A, B, C, D, E
-10 to +50°C	100
+55°C	85
+60°C	70

Output Derating (Forced Air Cooling)

For forced air cooling, airflow of 0.7m/s above is needed for component side.

As a reference for forced cooling, let air flow so that E-cap. C6 temperature becomes lower than 85°C.

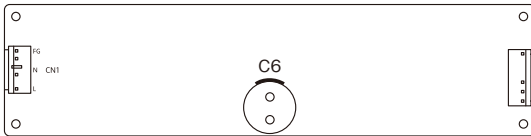

2 Output Derating according to the Mounting Directions (With Cover & Chassis type : MODEL ZWS-AF/JA)

This series has cover & chassis model as option. Recommended standard mounting method is (A). Method (B), (C), (D), (E) are also possible. (Method F is impossible.) Refer to the derating below. In the following derating curve, the average output current is considered to be 100%

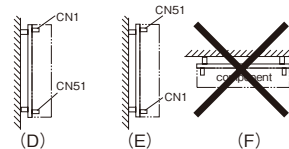
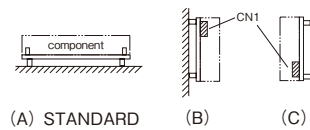

ZWS50AF, 75AF, 100AF

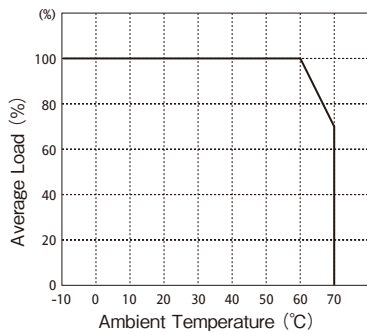

ZWS50AF, 75AF Output Derating

Mounting Ta	LOAD (%)
	A, B, C, D, E
-10 to +60°C	100
+65°C	85
+70°C	70

Output Derating (Convection Cooling)

ZWS50AF/JA

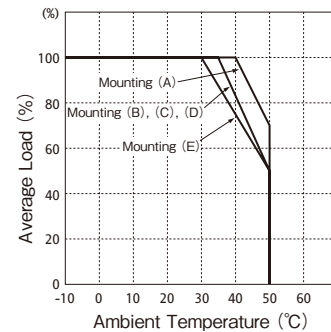

ZWS50AF/JA Output Derating

Mounting Ta	LOAD (%)					
	A	B	C	D	E	F
-10 to +30°C	100	100	100	100	100	-
+35°C	100	100	100	100	88	-
+40°C	100	83	83	83	75	-
+45°C	85	66	66	66	62	-
+50°C	70	50	50	50	50	-

ZWS75AF/JA

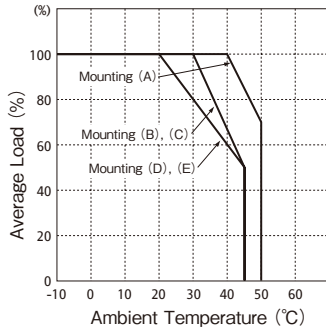

ZWS75AF/JA Output Derating

Mounting Ta	LOAD (%)					
	A	B	C	D	E	F
-10 to +20°C	100	100	100	100	100	-
+30°C	100	100	100	80	80	-
+40°C	100	66	66	60	60	-
+45°C	85	50	50	50	50	-
+50°C	70	-	-	-	-	-

ZWS100AF/JA

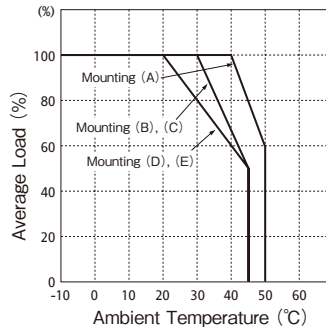

ZWS100AF/JA Output Derating

Mounting Ta	LOAD (%)					
	A	B	C	D	E	F
-10 to +20°C	100	100	100	100	100	-
+30°C	100	100	100	80	80	-
+40°C	100	67	67	60	60	-
+45°C	85	50	50	50	50	-
+50°C	60	-	-	-	-	-

ZWS150AF/JA

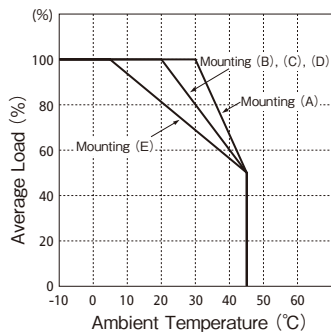

ZWS150AF/JA Output Derating

Mounting Ta	LOAD (%)					
	A	B	C	D	E	F
-10 to +5°C	100	100	100	100	100	-
+20°C	100	100	100	100	81	-
+30°C	100	80	80	80	68	-
+40°C	65	60	60	60	56	-
+45°C	50	50	50	50	50	-

Output Derating (Forced Air Cooling)

For usage of ZWS-AF/JA model, method is the same as the standard type (ZWS-AF) forced cooling. Mounting method (F) is impossible.

ZWS50AF/JA,75AF/JA

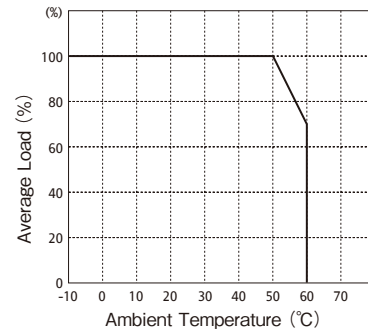

ZWS50AF/JA, 75AF/JA Output Derating

Mounting Ta	LOAD (%)	
	A, B, C, D, E	F
-10 to +50°C	100	-
+55°C	85	-
+60°C	70	-

ZWS100AF/JA

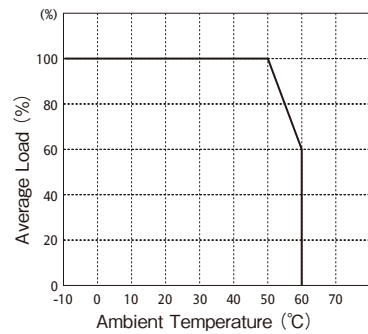

ZWS100AF/JA Output Derating

Mounting Ta	LOAD (%)	
	A, B, C, D, E	F
-10 to +50°C	100	-
+55°C	80	-
+60°C	60	-

ZWS150AF/JA

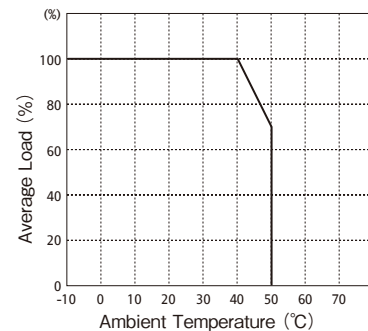

ZWS150AF/JA Output Derating

Mounting Ta	LOAD (%)	
	A, B, C, D, E	F
-10 to +40°C	100	-
+45°C	85	-
+50°C	70	-

• All specifications are subject to change without notice.

3 Mounting Method

Please use the mounting hole as :

ZWS50AF - ZWS150AF : 4 holes of $\phi 3.5$

And insert the spacer (MAX $\phi 8\text{mm}$) of height over 8mm to lift the unit. Also use all 4 mounting holes for the unit installation. The vibration spec. is the value taken when the unit is raised by 8mm spacers.

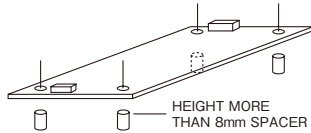

And allowable area by metal pieces is 9mm from each PCB corners. Refer to figure below.

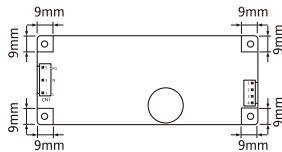

Please leave 4mm space from the surfaces and the sides of PCB, especially from the solder surface, 8mm space is necessary. If the space is not enough, the specification of insulation and withstand will not be satisfied.

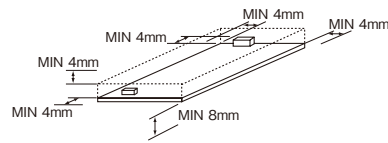

FG should be connected to the earth terminal of the apparatus. If not, the conducted noise and output noise will increase.

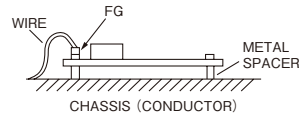

5. Wiring Method

- The output load line and input line shall be separated and twisted to improve noise sensitivity.
- Use all lines as thick and short as possible to make lower impedance.
- Noise can be eliminated by attaching a capacitor to the load terminals.
- For safety and EMI considerations, connect FG to ground terminal of equipment where power supply is

- mounted on.
- Recommended screw torque is 0.49N.m (5kg.cm).
- Select the wire materials to adapt the connector as follows.

INPUT: ZWS50AF ~ 150AF---AWG#22 ~ #18
 OUTPUT: ZWS50AF ~ 150AF---AWG#22 ~ #18

6. External Fuse Rating

Refer to the following fuse rating when selecting the external fuses that are to be used on input line. Surge current flows when line turns on. Therefore use slow-blow fuse or time-lag fuse. Do not use fast-blow fuse. Fuse rating is specified by in-rush current value at line turn-on. Do not select the fuse according to input current (rms.) values under the actual load condition.

ZWS50AF: 2.0A
 ZWS75AF: 3.15A
 ZWS100AF: 3.15A
 ZWS150AF: 5.0A

7. Before concluding that the unit is at fault...

Before concluding that the unit is at fault, make the following checks.

- Check if the rated input voltage is connected.
- Check if the wiring of input and output is correct.
- Check if the wire material is not too thin.
- Check if the output voltage control (V.ADJ) is properly adjusted.
- Check if the output current and output wattage dose not

- exceed specification.
- Audible noise can be heard during dymmic-load operation.
- Audible noise can be heard when input voltage waveform is not sinusoidal wave.

8. Notes

1. Overvoltage Category II
2. Radio Interference Suppression Test is nor performed.

ZWS300 Instruction Manual

● ZWS5-50 Instruction Manual A-427

● ZWS50AF-150AF Instruction Manual A-433

BEFORE USING THE POWER SUPPLY UNIT

Pay attention to all cautions and warnings before using the unit. Incorrect usage could lead to an electric shock, damage to the unit or a fire hazard.

- Ensure the wiring to input terminal is connected correctly according to this instruction manual.
- This is PC board type power supply. Please hold on the board side while mounting, and not to touch the component side. In using for the apparatus, please lift the power supply with a spacer.

WARNING

- Do not touch the internal components, they may have high voltage or high temperature. You may get electric shock or burned.
- When the unit is operating, keep your hands and face away from it, you may get injured by an accident.

CAUTION

- This power supply is primarily designed and manufactured to be used and enclosed in other equipment. Stick the WARNING label for users on the system equipment and describe the notice in the instruction manual.
- Never operate the unit under over current or shorted condition for 30 seconds or more which could result in damage or insulation failure. There is no possibility for fire or burning.

Note : CE MARKING

CE Marking, when applied to a product covered by this handbook, indicates compliance with the low voltage directive (73/23/EEC) as modified by the CE Marking Directive (93/68/EEC) which complies with EN60950.

1. Specifications

1 Input Voltage Range

85 - 132 /170 - 265VAC (47 - 440Hz)

3 Safety Standards

Approved by UL60950-1, CSA C22.2 No.60950-1, EN60950-1.
Built to meet DENAN.

2 Operating Temperature

-10°C to +40°C: 100% load, +60°C: 60% load (Convection Cooling)
-10°C to +50°C: 100% load, +70°C: 50% load (Forced air Cooling)

4 Input Voltage [VAC] and Current (Typ) [A]

INPUT \ MODEL	ZWS300-3	ZWS300-5	ZWS300-12	ZWS300-15	ZWS300-24	ZWS300-48
100VAC	5			7.5		
200VAC	3			4.5		

5 Nominal Output Voltage[V] and Maximum Output Current[A]

MODEL \ OUTPUT	3.3	5	12	15	24	48
ZWS300 Convection cooling	40	40	17	14	9	4.2
ZWS300 Forced air cooling	60	60	27	22	14	6.3

2. Explanation on Terminals

ZWS300

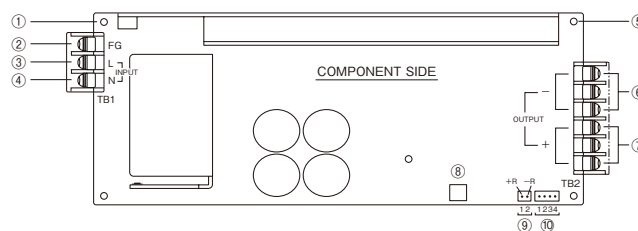

ZWS

①⑤ Frame Ground (FG)

Connected to FG terminal of TB1. Please ground to the apparatus with a spacer of conductive material.
(The mounting surface of the spacer should be within MAX φ 6.)

② Input terminal (FG) : Frame Ground

③ Input terminal (L) : Live line with a fuse inside

④ Input terminal (N) : Neutral line

⑥ - : - output terminal

⑦ + : + output terminal

3. Terminal Connection

Pay attention to the input wiring. If it is connected with wrong terminal, the power supply will be damaged.

ZWS300

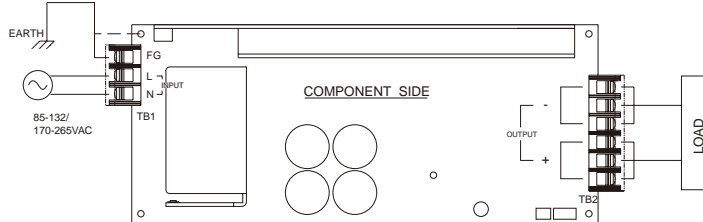

● The output current on one terminal is limited to 30A

Terminal in use (EMUDEN made)

Input side TB1: T6969-A

Output side TB2: T6970-A

4. Mounting Directions (Output Derating According to the Mouting Directions)

The power supply can be mounted on the equipment as the standard mounting (A), and others mounting as (B), (C), (D) and (E). But mounting (F) is not applicable, because the upper PCB make the heat left inside the power supply.

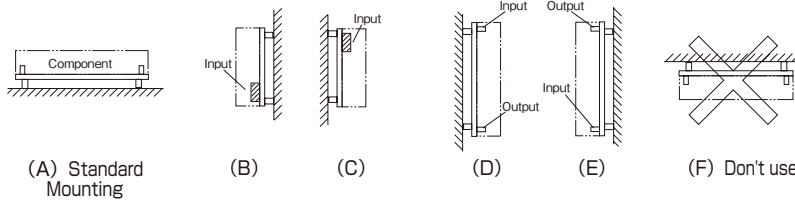

Model	ZWS300 convection cooling				
	A	B	C	D	E
Mounting Ta(°C)					
-10°C	100	100	100	100	100
0°C	100	100	100	100	100
30°C	100	100	100	100	100
40°C	100	80	80	80	80
50°C	80	60	60	60	60
60°C	60	—	—	—	—

Output Voltage (V)	Maximum Output Power (W)
3.3	132
5	200
12	204
15	210
24	216
48	201.6

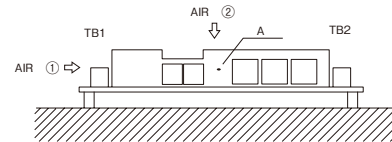

Please make air flow to maintain the heat sink (part A) temperature 85°C or less. (Operating ambient temperature is 50°C).

The air flow direction is Air ① or ② indicated in the above figure.

Model	ZWS300 Forced air cooling	
	Mounting Ta(°C)	Air flow direction ① or ②
-10°C	100	
0°C	100	
25°C	100	
40°C	100	
50°C	100	
60°C	70	
70°C	50	

Output Voltage (V)	Maximum Output Power (W)
3.3	198
5	300
12	324
15	330
24	336
48	302.6

5. Functions and Cautions

1 Input voltage

入力電圧範囲は、85 ~ 132VAC/170 ~ 265VAC (47 ~ 440Hz) 入力自動切換方式です。

Input which is out of specification may cause unit damage.

2 Output Voltage Range

V.ADJ trimmer on PCB can adjust the output volume. Output voltage range is within $\pm 10\%$ of nominal output voltage. Note that over voltage protection (OVP) function may trigger if the output voltage is increased excessively.

3 Over Voltage Protection (OVP)

This model is provided with a built-in, handy reset OVP circuit of output shutdown method. The output will be down when the output voltage is up to 115 - 135% of the rated. Once OVP circuit shut the output down, the output can only be recovered by turning off the input line and re-input the power after interval time.

The value of OVP is fixed.

4 Over Current Protection (OCP)

ZWS300 is provided with a built-in primary side OCP circuit with automatic recovery.

OCP is workable when the load is over 120% of the rated. The power supply will automatically recover when the overload or short conditions are cleared.

Please do not let the unit work under overload or short conditions over 30 seconds, or the power supply is feared to be damaged.

5 Ripple

The rated maximum ripple value is the test result measuring by the instructed ripple measuring circuit, using JEITA probe or other equivalent.

If the load cable is too long, please connect a capacitor (electrolytic film, etc.) to the load terminals to reduce the ripple on the load terminal.

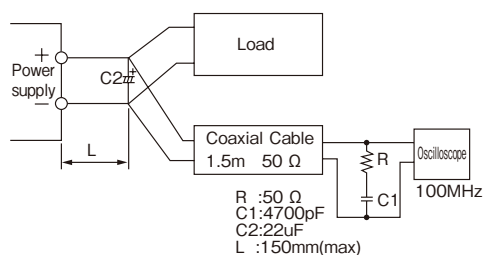

6 In-Rush Current

ZWS300 is provided with a built-in inrush current protection circuit.

ZWS300 is limited by method using thyristors.

Be care to select the switch and the outside fuse.

7 Remote Sensing

(1) When not using remote sensing

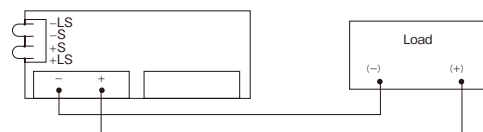

(2) When using remote sensing

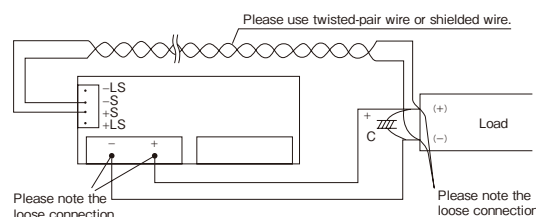

■ When the function of remote sensing is not used, connect +S terminal to +LS terminal, -S terminal to -LS terminal by short piece.

■ Please wire with removing short piece when you use the remote sensing.

■ リモートセンシングを使用時、負荷線に接触不良（ねじのゆるみ、コネクタの接触不良など）が生じると、センシング線に負荷電流が流れ、電源内部回路を破壊することがありますので結線には十分注意して下さい。

■ The total line voltage drop (+ side line and - side line) shall be less than 0.3V.

■ In case that sensing line is too long, it is necessary to put a capacitor.

■ +LS、-LS端子から出力を取り出さないで下さい。

8 Series Operataion

For series operation, either (A) or (B) is possible. Please use the output current value less than maximum output current of the series-connected power supply of whichever the maimum output current is smaller.

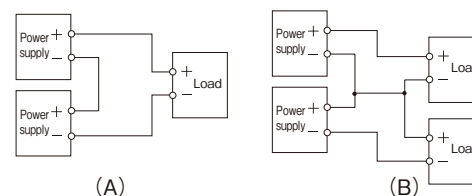

9 Parallel Operation

(A) To increase the output current is not possible.

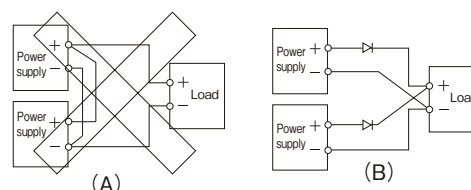

(B) To use as back-up power supply

1. Set power supply output voltage higher by the forward voltage drop (V_F) of diode.
2. Adjust the output voltage of each power supply to be the same.
3. Use within the specifications for output voltage and output power.

10 Remote ON/OFF Control (Optional)

Remote ON/OFF control function is available as option with model name followed by "/R". Using this function allows the user to turn the all outputs on and off without having to turn the AC input on and off. 基板上的コネクタ (+R、-R) に、外部電圧印加による制御方法です。It is controlled by the voltage applied to +R and -R. This current is in the secondary (output) side of the power supply unit. Do not connect in the primary (input) side. And this circuit is isolated from the output by a photocoupler.

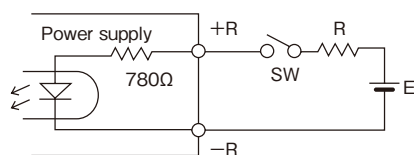

+R -R	Output
SW ON(More than 4.5V)	ON
SW OFF(Less than 0.8V)	OFF

外部電源 : E	制限抵抗値 : R
4.5 - 12.5VDC	No need
12.5 - 24.5VDC	1.5kΩ

11 Insulation Resistance Test

The insulation resistance value is above 100MΩ at

500VDC.

Considering the safety, please set the voltage value of DC insulation meter before the test, and well discharge the insulation meter after the test.

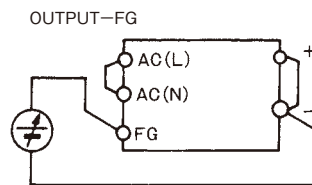

12 Withstand Voltage Test

ZWS300 is designed to be able to withstand 3kVAC (10mA) 1minute between input-output, 2kVAC (10mA) 1minute between input-FG, and 500VAC (100mA) 1 minute between output-FG.

Please set the limit current value of the withstand voltage tester as mentioned above before doing test.

Please elevate the applying voltage gradually, and lower it gradually, too, when shutdown.

Please do not use a timer in the test.

Because when the test voltage is supplied or shutdown, an impulse high voltage may be generated which will break the power supply unit.

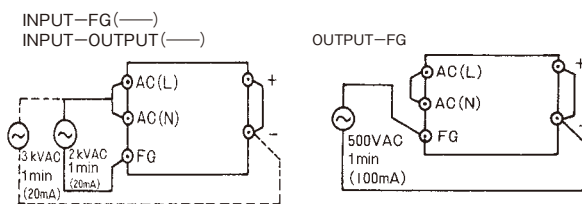

6. Mounting Method

Please use the mounting hole as:

ZWS300: 5 holes of $\phi 3.5$

and insert the spacer (MAX $\phi 6.0$) of height over 8mm to lift the unit.

The vibration spec is the value taken when the unit is raised by 8mm spacers.

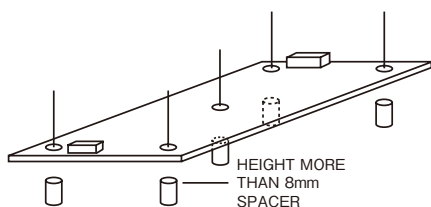

Please left 5mm space from the surfaces and left 4mm space from the sides of PCB, especially from the solder surface, 8mm space is necessary.

If the space is not enough, the specification of insulation and withstand will not be satisfied.

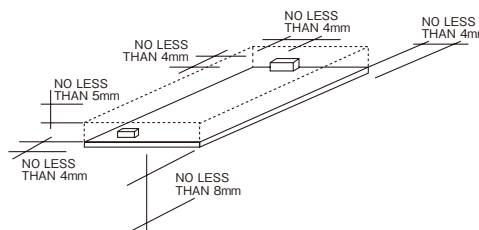

FG should be connected to the earth terminal of the apparatus.

If not, the conducted noise and output noise will increase.

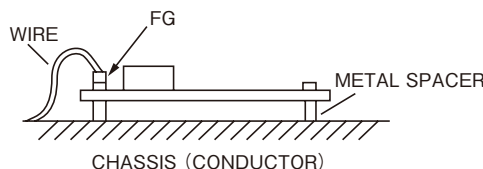

7. Wiring Method

The input line and output load shall be separated and twisted to improve noise sensitivity.

Noise can be eliminated by attaching a capacitor to the load terminals.

8. External Fuse Rated Current

When using an outside fuse, please select the fuse capacity as follows. Moreover, please do not use the fast blow fuse.

Model NO.	Rated current of fuse
ZWS300	15A

9. Repair

In case of damage or repair of this product, please return to our service center or factory.

10. Before concluding that the unit is at fault...

- Check if the rated input voltage is connected.
- Check if the wiring of input and output are correct.
- Ensure the input and output connectors are firmly inserted and the pressing of the connector pins are exactly fixed.
- Check if the wiring material is not too thin.
- 出力可変ボリュームを回し過ぎていませんか。
- Ensure that a large capacitor is not connected on the output side.

Please use within maximum capacitance shown below.

	Maximum capacitance					
	3.3V	5V	12V	15V	24V	48V
ZWS300	15,000 μ F		30,000 μ F			

TDK-Lambda