

SACB-8/16-SC SCO P - Sensor/actuator box



1452974

<https://www.phoenixcontact.com/us/products/1452974>

Please be informed that the data shown in this PDF document is generated from our online catalog. Please find the complete data in the user documentation. Our general terms of use for downloads are valid.



Sensor/actuator box, application: Standard, connection method: M12-SPEEDCON-socket Plastic, number of slots: 8, number of positions: 5, coding: A, slot assignment: Double, status display: No, Universal; master cable connection: Spring-cage connection 180°, shielding: no

Your advantages

- Safety in the field, thanks to molded housing and high degree of protection
- Save space: distributor box with double occupancy for two sensors in one slot
- Save time, thanks to installation with SPEEDCON fast locking system
- Flexible: distributor box with connector hood for on-site assembly

Commercial data

Item number	1452974
Packing unit	1 pc
Minimum order quantity	1 pc
Sales key	BF41
Product key	BF3CBC
Catalog page	Page 262 (C-2-2019)
GTIN	4046356553599
Weight per piece (including packing)	222.1 g
Weight per piece (excluding packing)	221.5 g
Customs tariff number	85366990
Country of origin	DE

SACB-8/16-SC SCO P - Sensor/actuator box



1452974

<https://www.phoenixcontact.com/us/products/1452974>

Technical data

Notes

General	<p>When connecting the signal lines to the black PCB terminal blocks, please use a 0.4 x 2.0 mm screwdriver.</p> <p>The black PCB terminal blocks only require a minimal amount of operating force.</p> <p>Screwdriver: SZS 0,4X2,0 - 1205202</p> <p>Using larger screwdrivers or excessive force may damage the PCB terminal blocks.</p> <p>When using ferrules, the wires can be inserted straight into the PCB terminal blocks without opening the clamping area.</p>
General	<p>NOTE: Observe the permissible bending radii when laying conductors, since the degree of protection may be put in jeopardy if the bending forces are too high. Alleviate mechanical loads upstream of the connector, e.g. by using cable ties.</p>
General	<p>Unused slots are to be sealed off prior to commissioning.</p> <p>Suitable sealing elements are to be found under "Accessories".</p>

Product properties

Product type	Distributor boxes with M8 to M12 slots
Number of positions	5
Application	Standard
Number of slots	8
Coding	A
LED	No

Material specifications

Material	PBT
	PBT
	PUR
Flammability rating according to UL 94	V0
Seal material O-ring	NBR
Contact material	Cu alloy
Contact surface material	gold-plated
Contact carrier material	PA

Dimensions

Dimensional drawing	
Width	54 mm

SACB-8/16-SC SCO P - Sensor/actuator box



1452974

<https://www.phoenixcontact.com/us/products/1452974>

Height	42 mm
Length	149 mm

Connection data

Conductor connection

Connection method	Spring-cage connection
Stripping length	6 mm
	10 mm
Conductor cross section Flexible signal line	0.2 mm ² ... 0.5 mm ²
Conductor cross section Flexible power supply	0.2 mm ² ... 1.5 mm ²
Connection cross section AWG Flexible signal line	24 ... 20
Connection cross section AWG Flexible power supply	24 ... 16
Tightening torque, cover screw	1 Nm
Tightening torque slot sensor/actuator cable	0.4 Nm
Tightening torque of mounting screw for fixing the housing	0.5 Nm

Pin assignment

Slot/position = Wire color or connection	1 / 4 (A) = WH
	1 / 2 (B) = GYPK
	2 / 4 (A) = GN
	2 / 2 (B) = RDBU
	3 / 4 (A) = YE
	3 / 2 (B) = WHGN
	4 / 4 (A) = GY
	4 / 2 (B) = BNGN
	5 / 4 (A) = PK
	5 / 2 (B) = WHYE
	6 / 4 (A) = RD
	6 / 2 (B) = YEBN
	7 / 4 (A) = BK
	7 / 2 (B) = WHGY
	8 / 4 (A) = VT
	8 / 2 (B) = GYBN
	1-8 / 1 (+ 120 V) = BN
1-8 / 3 (0 V) = BU	
1-8 / 5 (PE) = GNYE	

Signaling

Status display present	No
------------------------	----

Electrical properties

Nominal voltage U _N	120 V AC
	120 V DC
Rated current, total	12 A

SACB-8/16-SC SCO P - Sensor/actuator box



1452974

<https://www.phoenixcontact.com/us/products/1452974>

Max. current carrying capacity per path	2 A
Current carrying capacity per slot	4 A

Cable/line

Sensor/actuator connection system	M12-SPEEDCON-socket
Connection method	Spring-cage connection
External cable diameter	7 mm ... 12 mm
Metric conductor cross section (Signal)	0.2 mm ² ... 0.5 mm ²
Cross section AWG (Signal)	24 ... 20
Stripping length (signal)	6 mm
Metric conductor cross section (Power)	0.2 mm ² ... 1.5 mm ²
Cross section AWG (Power)	24 ... 16
Stripping length (power)	10 mm
Stripping length for sheath	50 mm (Master cable)
Tightening torque, cover screw	1 Nm
Tightening torque of mounting screw for fixing the housing	0.5 Nm
Tightening torque slot sensor/actuator cable	0.4 Nm
Tightening torque, union nut	2.5 Nm

Standards and regulations

Standard designation	M12 connector
Standards/specifications	IEC 61076-2-101

Environmental and real-life conditions

Ambient conditions

Degree of protection	IP65
	IP67
Ambient temperature (operation)	-25 °C ... 80 °C

SACB-8/16-SC SCO P - Sensor/actuator box



1452974

<https://www.phoenixcontact.com/us/products/1452974>

Drawings

Schematic diagram

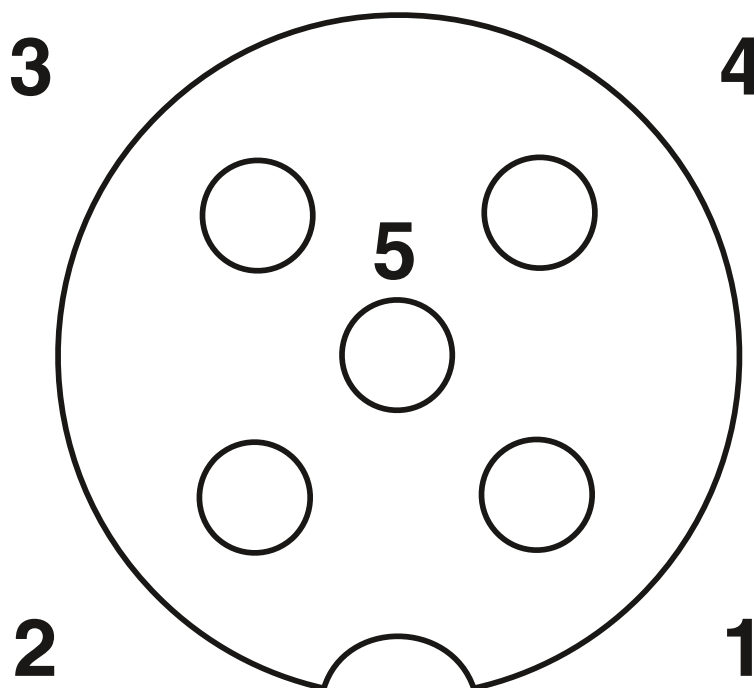

M12 slot, socket, 5-pos.

SACB-8/16-SC SCO P - Sensor/actuator box



1452974

<https://www.phoenixcontact.com/us/products/1452974>

Circuit diagram

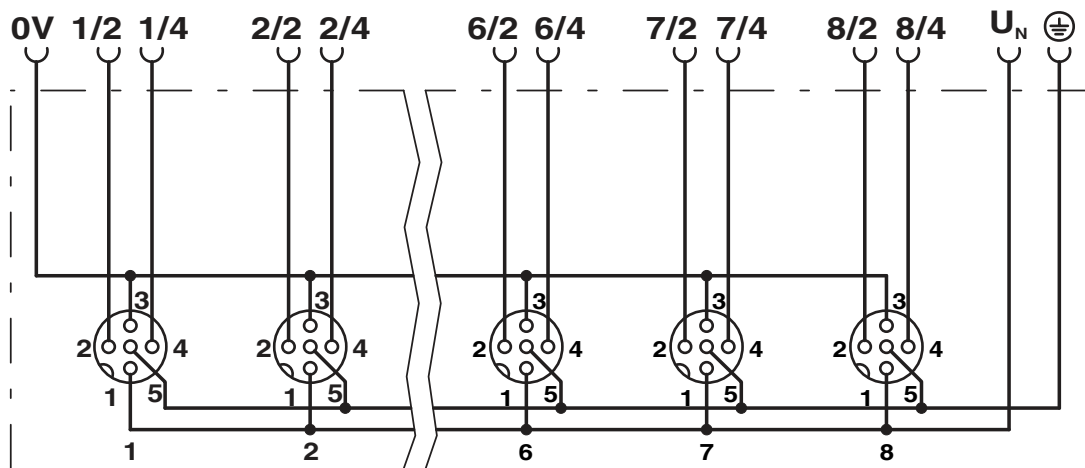

SACB-8/16-SC SCO P - Sensor/actuator box



1452974

<https://www.phoenixcontact.com/us/products/1452974>

Dimensional drawing

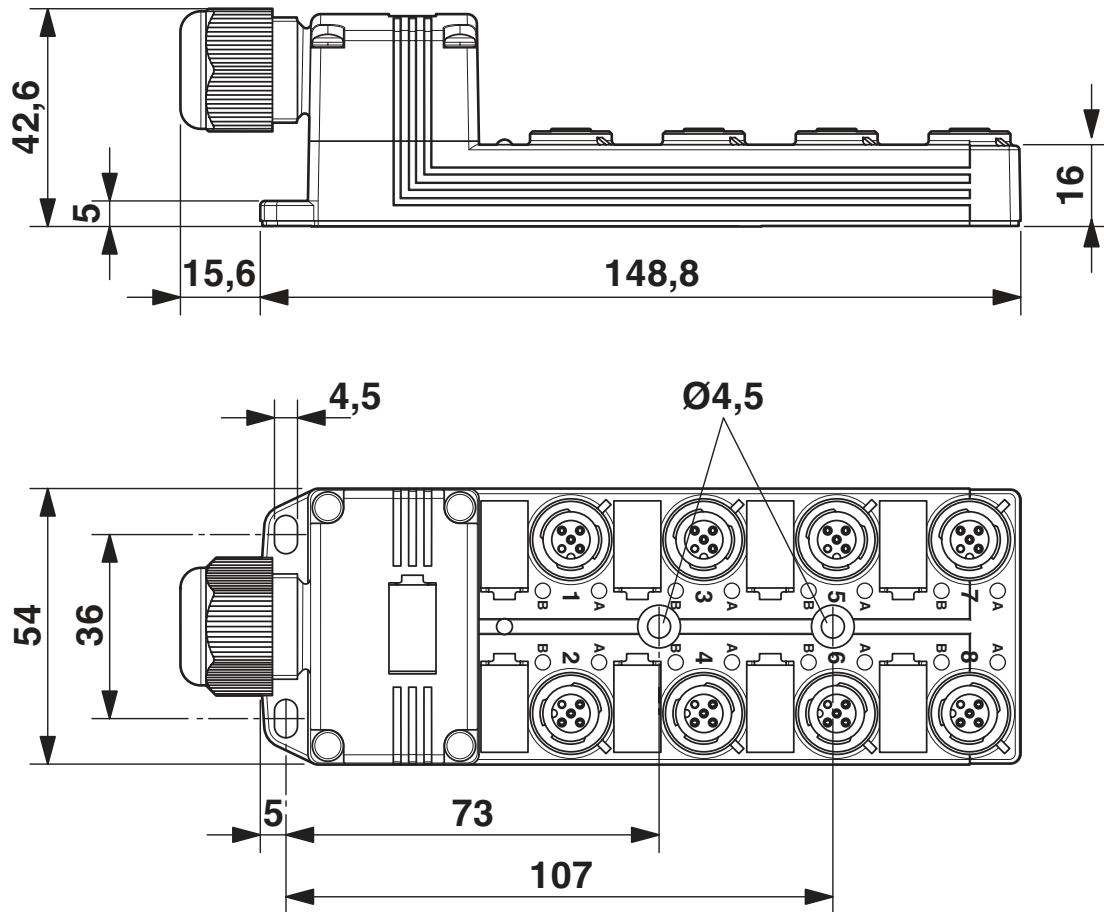

SACB-8/16-SC SCO P - Sensor/actuator box



1452974

<https://www.phoenixcontact.com/us/products/1452974>

Approvals

To download certificates, visit the product detail page: <https://www.phoenixcontact.com/us/products/1452974>

 cUL Recognized Approval ID: FILE E 118976				
	Nominal voltage U_N	Nominal current I_N	Cross section AWG	Cross section mm^2
	120 V	-	-	-

 UL Recognized Approval ID: FILE E 118976				
	Nominal voltage U_N	Nominal current I_N	Cross section AWG	Cross section mm^2
	120 V	-	-	-

 EAC Approval ID: RU C-DE.AI30.B.01102	
--	--

 EAC Approval ID: RU C-DE.BL08.B.00511	
---	--

cULus Recognized	
-------------------------	--

SACB-8/16-SC SCO P - Sensor/actuator box



1452974

<https://www.phoenixcontact.com/us/products/1452974>

Classifications

ECLASS

ECLASS-11.0	27440111
ECLASS-12.0	27440111
ECLASS-13.0	27440111

ETIM

ETIM 8.0	EC003558
----------	----------

UNSPSC

UNSPSC 21.0	31251500
-------------	----------

SACB-8/16-SC SCO P - Sensor/actuator box



1452974

<https://www.phoenixcontact.com/us/products/1452974>

Environmental product compliance

China RoHS	Environmentally friendly use period: unlimited = EFUP-e
	No hazardous substances above threshold values

SACB-8/16-SC SCO P - Sensor/actuator box



1452974

<https://www.phoenixcontact.com/us/products/1452974>

Accessories

SACB-16X0,5/ 3X1,0-50,0 PUR - Master cable ring

1503373

<https://www.phoenixcontact.com/us/products/1503373>



Master cable for sensor/actuator boxes, with PE conductor, unshielded, material PUR/PP, 19-pos., 16 x 0.50 mm² and 3 x 1.00 mm², length: 50 m

SACB-16X0,5/ 3X1,0-200,0 PUR - Master cable ring

1559893

<https://www.phoenixcontact.com/us/products/1559893>



Master cable for sensor/actuator boxes, with PE conductor, unshielded, material PUR/PP, 19-pos., 16 x 0.50 mm² and 3 x 1.00 mm², length: 200 m on drum

SACB-8/16-SC SCO P - Sensor/actuator box



1452974

<https://www.phoenixcontact.com/us/products/1452974>

SACB-16X0,5/ 3X1,0-50,0 VPUR - Master cable ring

1430938

<https://www.phoenixcontact.com/us/products/1430938>



Master cable for sensor/actuator boxes, with PE conductor, unshielded, material PUR/PP, 19-pos., 16 x 0.50 mm² and 3 x 1.00 mm², length: 50 m

PROT-MS SCO - Screw plug

1553129

<https://www.phoenixcontact.com/us/products/1553129>



M12 screw plug with fast-locking system for unoccupied M12 female connectors of sensor/actuator cables, boxes, and flush-type connectors

SACB-8/16-SC SCO P - Sensor/actuator box



1452974

<https://www.phoenixcontact.com/us/products/1452974>

TSD 04 SAC - Torque screwdriver

1208429

<https://www.phoenixcontact.com/us/products/1208429>



Torque screwdriver, with preset torque of 0.4 Nm and 4 mm hexagonal drive for M12 connectors

TSD-M 1,2NM - Torque screwdriver

1212224

<https://www.phoenixcontact.com/us/products/1212224>



Torque screw driver, accuracy as per EN ISO 6789 standard, adjustable from 0.3 - 1.2 Nm

SACB-8/16-SC SCO P - Sensor/actuator box



1452974

<https://www.phoenixcontact.com/us/products/1452974>

TSD-M SAC-BIT ADAPTER - Adapter insert

1212600

<https://www.phoenixcontact.com/us/products/1212600>



Adapter bit for TSD-M...torque tools, E6.3-1/4" drive with 4 mm hexagon to accommodate SAC bits

SAC BIT M12-D15 - Tool

1208432

<https://www.phoenixcontact.com/us/products/1208432>



Nut for assembling sensor/actuator cables with M12 connector and M12 connectors for assembly, with a knurl diameter of 15 mm, for 4 mm hexagonal drive

SACB-8/16-SC SCO P - Sensor/actuator box

1452974

<https://www.phoenixcontact.com/us/products/1452974>



SACC BIT M12-D20 - Tool

1208445

<https://www.phoenixcontact.com/us/products/1208445>

Nut for assembling M12 connectors for assembly with a knurl diameter of 20 mm, for 4 mm hexagonal drive



UC-EM (17,5X9) - Snap-in markers

0827490

<https://www.phoenixcontact.com/us/products/0827490>

Snap-in markers, Sheet, white, unlabeled, can be labeled with: BLUEMARK ID, BLUEMARK ID COLOR, BLUEMARK CLED, BLUEMARK LED, CMS-P1-PLOTTER, PLOTMARK, mounting type: snapped, lettering field size: 17.5 x 9 mm, Number of individual labels: 20



SACB-8/16-SC SCO P - Sensor/actuator box



1452974

<https://www.phoenixcontact.com/us/products/1452974>

UC-EM (17,5X9) CUS - Snap-in markers

0828238

<https://www.phoenixcontact.com/us/products/0828238>



Snap-in markers, can be ordered: by sheet, white, labeled according to customer specifications, mounting type: snapped into marker carrier, lettering field size: 17.5 x 9 mm, Number of individual labels: 20

UCT-EM (17,5X9) - Snap-in markers

0801491

<https://www.phoenixcontact.com/us/products/0801491>



Snap-in markers, Sheet, white, unlabeled, can be labeled with: TOPMARK NEO, TOPMARK LASER, BLUEMARK ID COLOR, BLUEMARK ID, BLUEMARK CLED, THERMOMARK PRIME, THERMOMARK CARD 2.0, THERMOMARK CARD, mounting type: snapped, lettering field size: 17.5 x 9 mm, Number of individual labels: 24

SACB-8/16-SC SCO P - Sensor/actuator box



1452974

<https://www.phoenixcontact.com/us/products/1452974>

UCT-EM (17,5X9) CUS - Snap-in markers

0801575

<https://www.phoenixcontact.com/us/products/0801575>

UniCard sheet, for labeling devices from other manufacturers, for overview table see download area, labeled according to customer specifications



UC-EM (17,5X9) YE - Snap-in markers

0827494

<https://www.phoenixcontact.com/us/products/0827494>

Snap-in markers, Sheet, yellow, unlabeled, can be labeled with: BLUEMARK ID COLOR, BLUEMARK ID, BLUEMARK CLED, PLOTMARK, CMS-P1-PLOTTER, mounting type: snapped, lettering field size: 17.5 x 9 mm, Number of individual labels: 20

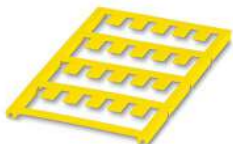

SACB-8/16-SC SCO P - Sensor/actuator box

1452974

<https://www.phoenixcontact.com/us/products/1452974>

UC-EM (17,5X9) YE CUS - Snap-in markers

0828239

<https://www.phoenixcontact.com/us/products/0828239>

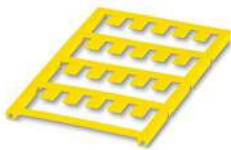

Snap-in markers, can be ordered: by sheet, yellow, labeled according to customer specifications, mounting type: snapped into marker carrier, lettering field size: 17.5 x 9 mm, Number of individual labels: 20

UCT-EM (17,5X9) YE - Snap-in markers

0801492

<https://www.phoenixcontact.com/us/products/0801492>



Snap-in markers, Sheet, yellow, unlabeled, can be labeled with: TOPMARK NEO, TOPMARK LASER, BLUEMARK ID COLOR, BLUEMARK ID, BLUEMARK CLED, THERMOMARK PRIME, THERMOMARK CARD 2.0, THERMOMARK CARD, mounting type: snapped, lettering field size: 17.5 x 9 mm, Number of individual labels: 24

SACB-8/16-SC SCO P - Sensor/actuator box

1452974

<https://www.phoenixcontact.com/us/products/1452974>



UCT-EM (17,5X9) YE CUS - Snap-in markers

0801576

<https://www.phoenixcontact.com/us/products/0801576>

UniCard sheet, for labeling devices from other manufacturers, for overview table see download area, labeled according to customer specifications



SZK PZ2 VDE - Screwdriver

1206463

<https://www.phoenixcontact.com/us/products/1206463>

Screwdriver, PZ crosshead, VDE insulated, size: PZ 2 x 100 mm, 2-component grip, with non-slip grip



SACB-8/16-SC SCO P - Sensor/actuator box



1452974

<https://www.phoenixcontact.com/us/products/1452974>

TSD 25 SAC - Torque screwdriver

1212315

<https://www.phoenixcontact.com/us/products/1212315>



Torque screwdriver, with preset torque of 2.5 Nm and 4 mm hexagonal drive for the pressure nut of the connector hood

TSD-M 3NM - Torque screwdriver

1212225

<https://www.phoenixcontact.com/us/products/1212225>



Torque screw driver, accuracy as per EN ISO 6789 standard, adjustable from 1.2 - 3 Nm

SACB-8/16-SC SCO P - Sensor/actuator box



1452974

<https://www.phoenixcontact.com/us/products/1452974>

SAC BIT HOOD-W 24 - Tool

1212486

<https://www.phoenixcontact.com/us/products/1212486>

Nut for assembling pressure nuts with 24 mm wrench size, for 4 mm hexagonal drive



SF-BIT-PZ 2-50 - Screw insert

1212592

<https://www.phoenixcontact.com/us/products/1212592>

Screw bit, PZ crosshead, E6.3-1/4" drive, size: PZ 2 x 50 mm, hardened, suitable for holder according to DIN 3126-F6.3/ISO 1173



SACB-8/16-SC SCO P - Sensor/actuator box



1452974

<https://www.phoenixcontact.com/us/products/1452974>

SZS 0,4X2,0 - Screwdriver

1205202

<https://www.phoenixcontact.com/us/products/1205202>



Micro screwdriver, bladed, size: 0.4 x 2.0 x 60 mm, 2-component grip, with non-slip grip and twist cap

A 0,5 - 6 - Ferrule

3200218

<https://www.phoenixcontact.com/us/products/3200218>



Ferrule, length: 6 mm, color: silver

SACB-8/16-SC SCO P - Sensor/actuator box



1452974

<https://www.phoenixcontact.com/us/products/1452974>

A 0,75-10 - Ferrule

3200234

<https://www.phoenixcontact.com/us/products/3200234>



Ferrule, length: 10 mm, color: silver

A 1 -10 - Ferrule

3200250

<https://www.phoenixcontact.com/us/products/3200250>



Ferrule, length: 10 mm, color: silver

SACB-8/16-SC SCO P - Sensor/actuator box

1452974

<https://www.phoenixcontact.com/us/products/1452974>



A 1,5 -10 - Ferrule

3200276

<https://www.phoenixcontact.com/us/products/3200276>



Ferrule, length: 10 mm, color: silver

UTA 136 - DIN rail adapter

2853996

<https://www.phoenixcontact.com/us/products/2853996>



Universal DIN rail adapter, for screwing on switchgear

Phoenix Contact 2023 © - all rights reserved
<https://www.phoenixcontact.com>

Phoenix Contact USA
586 Fulling Mill Road
Middletown, PA 17057, United States
(+717) 944-1300
info@phoenixcon.com