

Evaluation set with Fiber Illumination

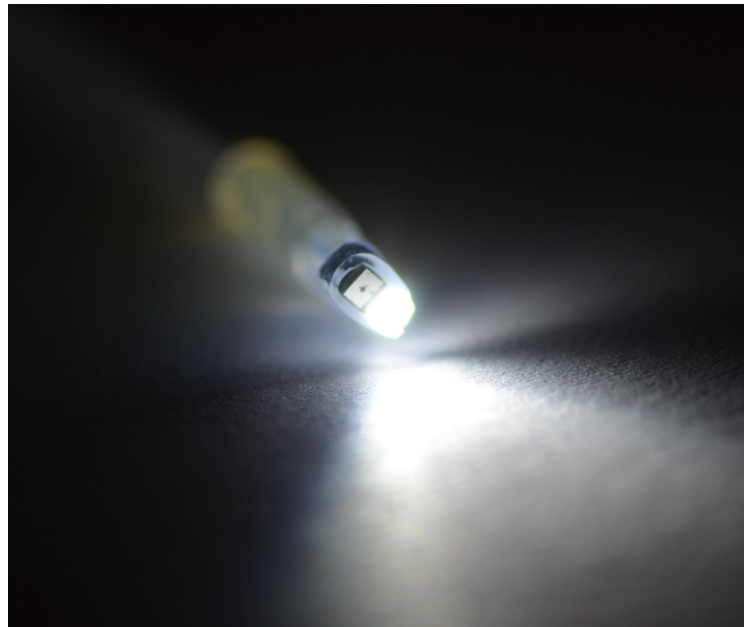

**AWAIBA**



Evaluation set with Fiber Illumination

Modifications and Updates

<i>Version</i>	<i>Date</i>	<i>Modifications</i>	<i>Author</i>
1.0.6	09/06/15	Updated Document	Fátima Baptista
1.0.7	17/03/17	Updated table 1 and section 6.1	Fátima Baptista



Evaluation set with Fiber Illumination

Table of Contents

1 Overview.....	4
2 Fiber optic light source.....	5
2.1 NanEye with Optical Fiber.....	6
2.1.1 Optional Assembly	7
2.2 NanEye Stereo with Optical Fiber	8
3 Mechanical Dimensions of Camera Head.....	9
3.1 NanEye with Lens and Cable Soldered Dipped (Bended).....	9
3.2 NanEye with Lens and Cable Soldered Dipped 90° (Not Bended).....	10
3.3 NanEye Stereo.....	11
4 Optic	12
5 Evaluation Kit Content.....	14
5.1 How to Install Awaiba Viewer.....	15
5.2 How to Start Awaiba Viewer	15
5.3 How to Use Awaiba Viewer	15
5.4 How to Debug	15
6 Package Options.....	17
6.1 Nano Fiber Demo Kit	17
7 Disclaimer.....	18

Index of Tables

Table 1: NanEye Fiber Demo Kit Specifications.....	5
--	---

Index of Figures

Figure 1: NanEye evaluation set overview block diagram.....	4
Figure 2: NanEye Fiber Demo Kit.....	5
Figure 3: Distal tip of the cable with the light source and the camera.....	6
Figure 4: Picture of NanEye together with POF illumination fiber.....	7
Figure 5: Stereo Camera with the light source	8
Figure 6: Measurements of the NANEYE module, Cable length may be adjusted to different lengths.....	9
Figure 7: Measurements of the NANEYE module, Cable length may be adjusted to different lengths.....	10
Figure 8: Measurements of the NanEye Stereo module (in mm).....	11
Figure 9: NanEye CTF measures.....	14
Figure 10: Starting the Viewer.....	15

1 Overview

NanEye is a tiny camera module which consists of a CMOS image sensor with a footprint size of 1mm x 1mm and, optionally, an adapted miniature optics. The device is mounted on a flat ribbon cable measuring up to 2m in length. Other cable lengths measuring up to 3m are possible upon request.

The Evaluation set consists of the NanEye base station which receives the NanEye sensors LVDS bit serial data stream and translates it to a USBII protocol that will interface over a standard USBII connection to a PC.

The supplied viewer software controls the NanEye camera, and displays the video images.

The fiber light source provides illumination over a 1mm diameter POF fiber to the tip of the camera

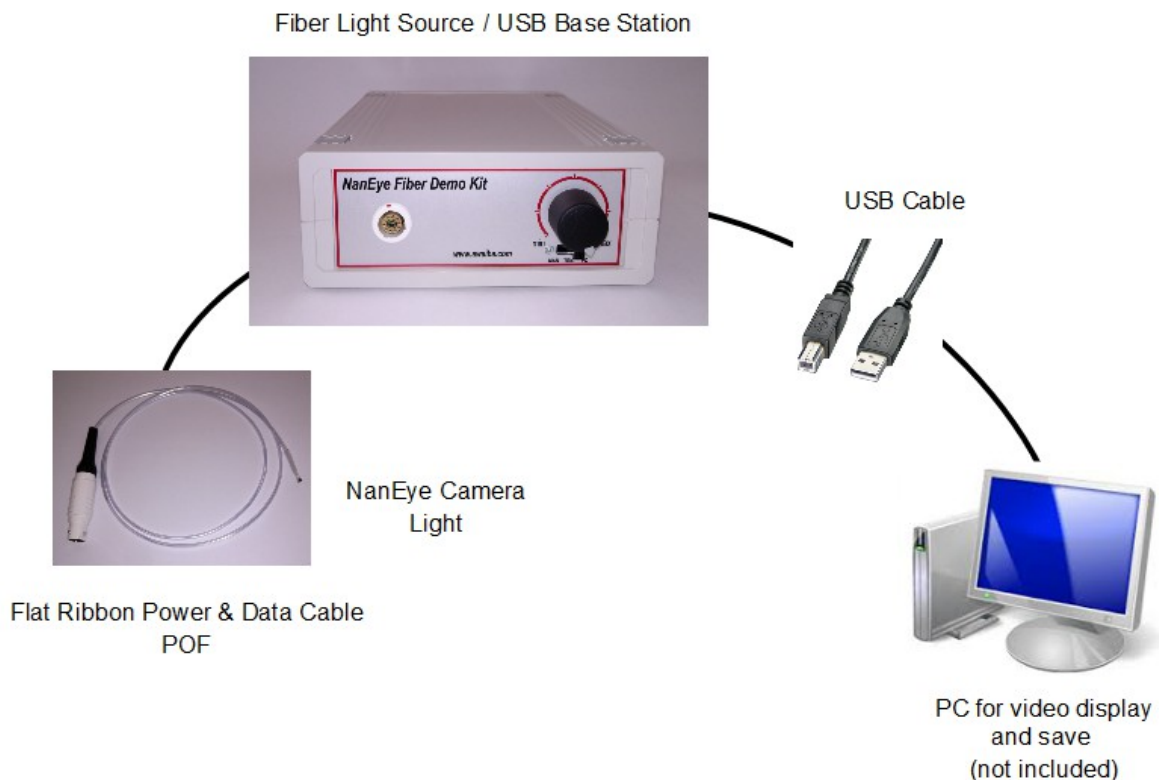

Figure 1: NanEye evaluation set overview block diagram

2 Fiber optic light source

Specifications		
PC Interface Protocol	USB2	
Programmable Unit	FPGA – Xilinx Spartan 3E	
Power Supply	Via USB 5V	
Dimensions	Width	16 cm
	Hight	6,1 cm
	Length	20 cm
Sensors	1 x NanEye 2D	
	1 x NanEye Stereo	

Table 1: NanEye Fiber Demo Kit Specifications

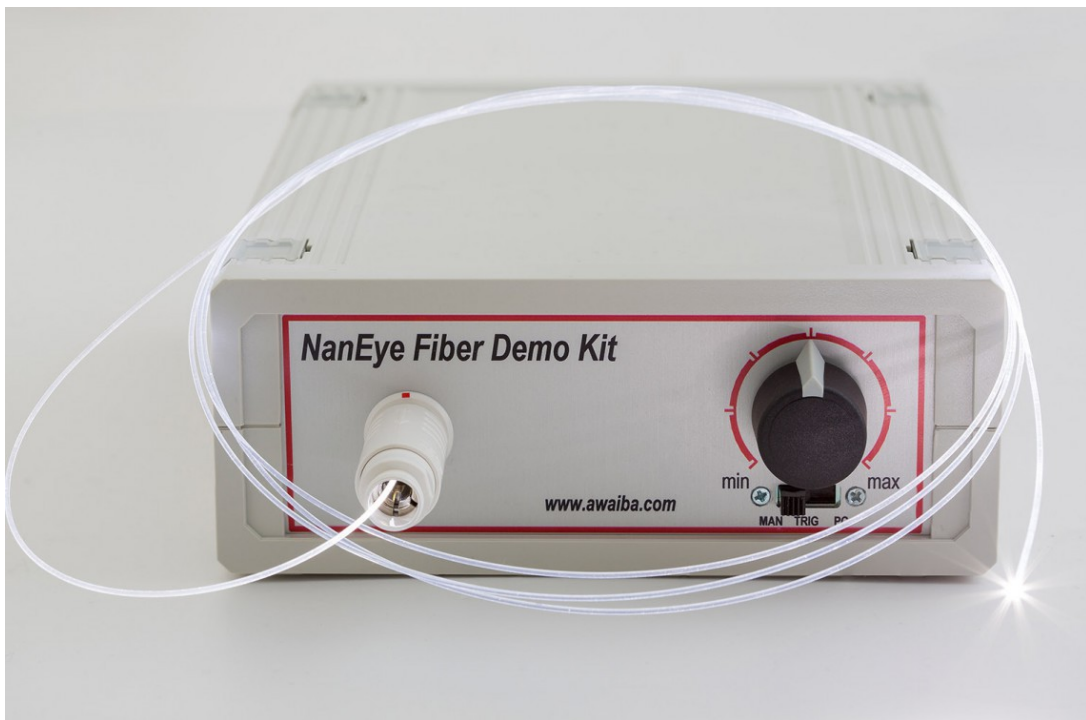

Figure 2: NanEye Fiber Demo Kit

The camera is at the distal tip of the cable. The light source is provided through fiber coupled LED and it is also on distal tip of the cable, in front of the camera.

2.1 NanEye with Optical Fiber

The whole assembly will come with the following diameter:

Camera + 0.5 mm fiber optic diameter + distal tip

Total diameter = 3.0 mm

POF fiber with 0.5 mm diameter, 1.4m cable length:

- 39 lux @ 30 cm (distance of the detector end of the fiber, measured on the optical axis)
- 89 lux @ 20 cm
- 144 lux @ 15 cm



Figure 3: Distal tip of the cable with the light source and the camera

2.1.1 Optional Assembly

The whole assembly with 1mm fiber optic diameter will come with the following dimensions:

Camera + 1 mm fiber optic diameter + cover tube

Total diameter \approx 3.0 mm

POF fiber with 1 mm diameter, 2m cable length:

- 125 lux @ 30 cm
- 305 lux @ 20 cm
- 525 lux @ 15 cm

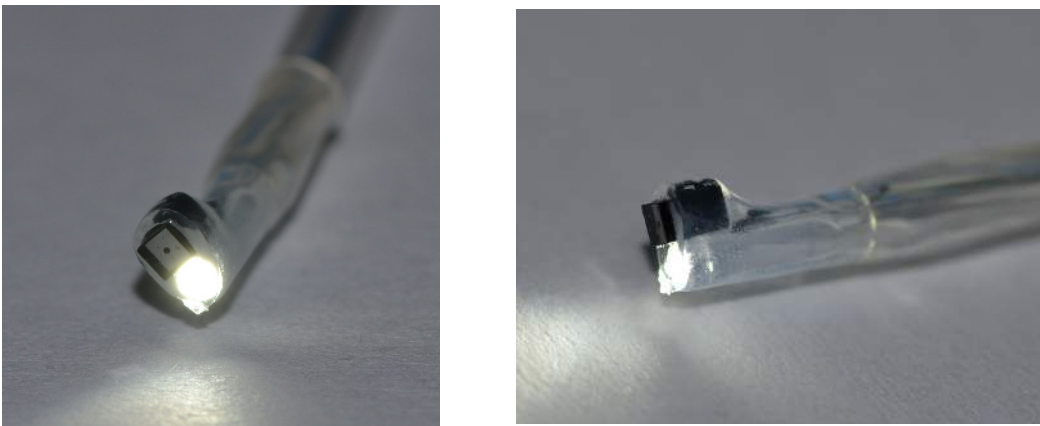

Figure 4: Picture of NanEye together with POF illumination fiber

2.2 NanEye Stereo with Optical Fiber

The whole assembly with 1mm fiber optic diameter will come with the following dimensions:

Camera + 1 mm fiber optic diameter + cover tube

Total diameter \approx 3.0 mm

POF fiber with 1 mm diameter, 2m cable length

- 125 lux @ 30 cm
- 305 lux @ 20 cm
- 525 lux @ 15 cm



Figure 5: Stereo Camera with the light source

3 Mechanical Dimensions of Camera Head

3.1 NanEye with Lens and Cable Soldered Dipped (Bended)

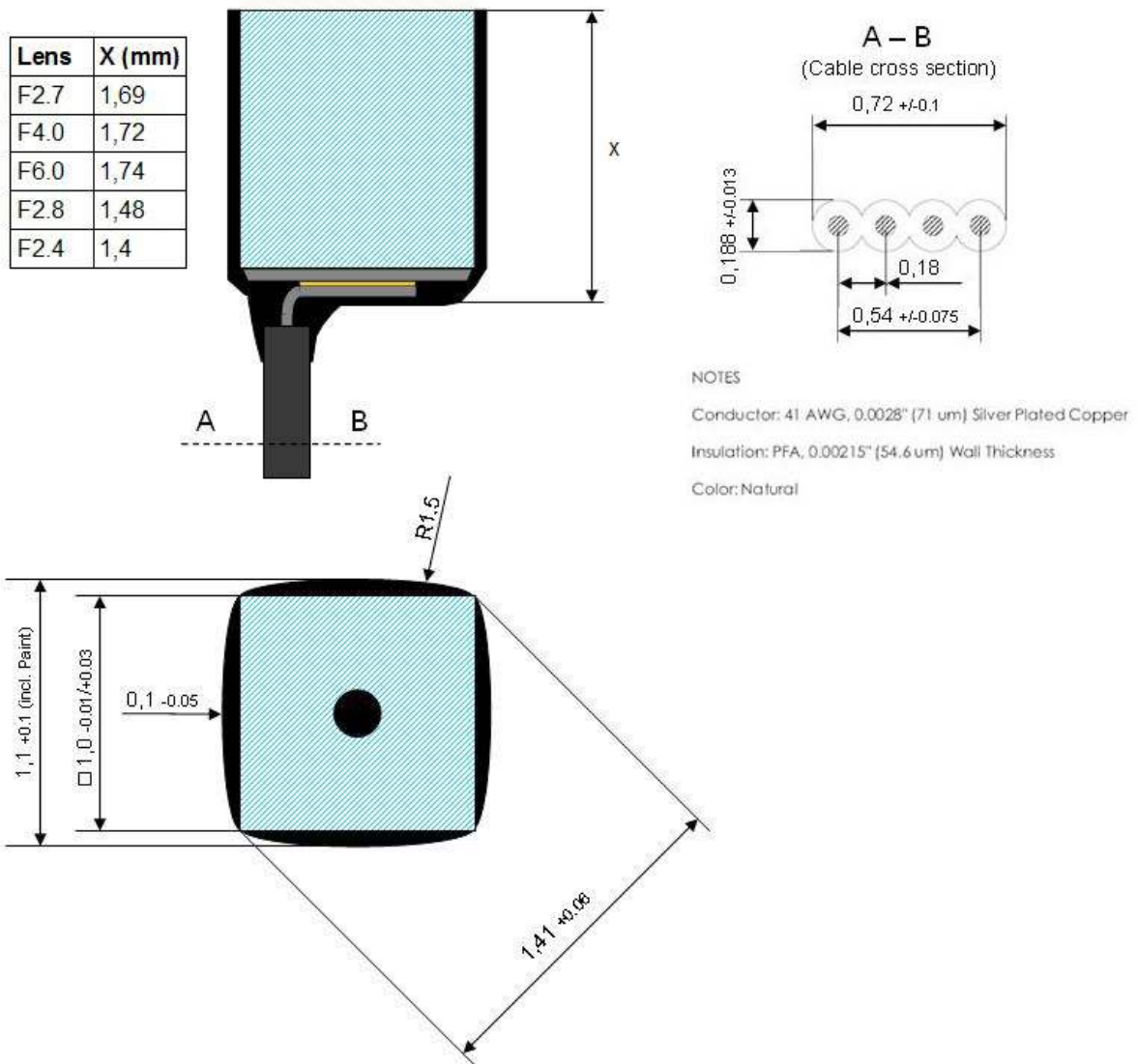

Figure 6: Measurements of the NANEYE module, Cable length may be adjusted to different lengths

3.2 NanEye with Lens and Cable Soldered Dipped 90° (Not Bended)

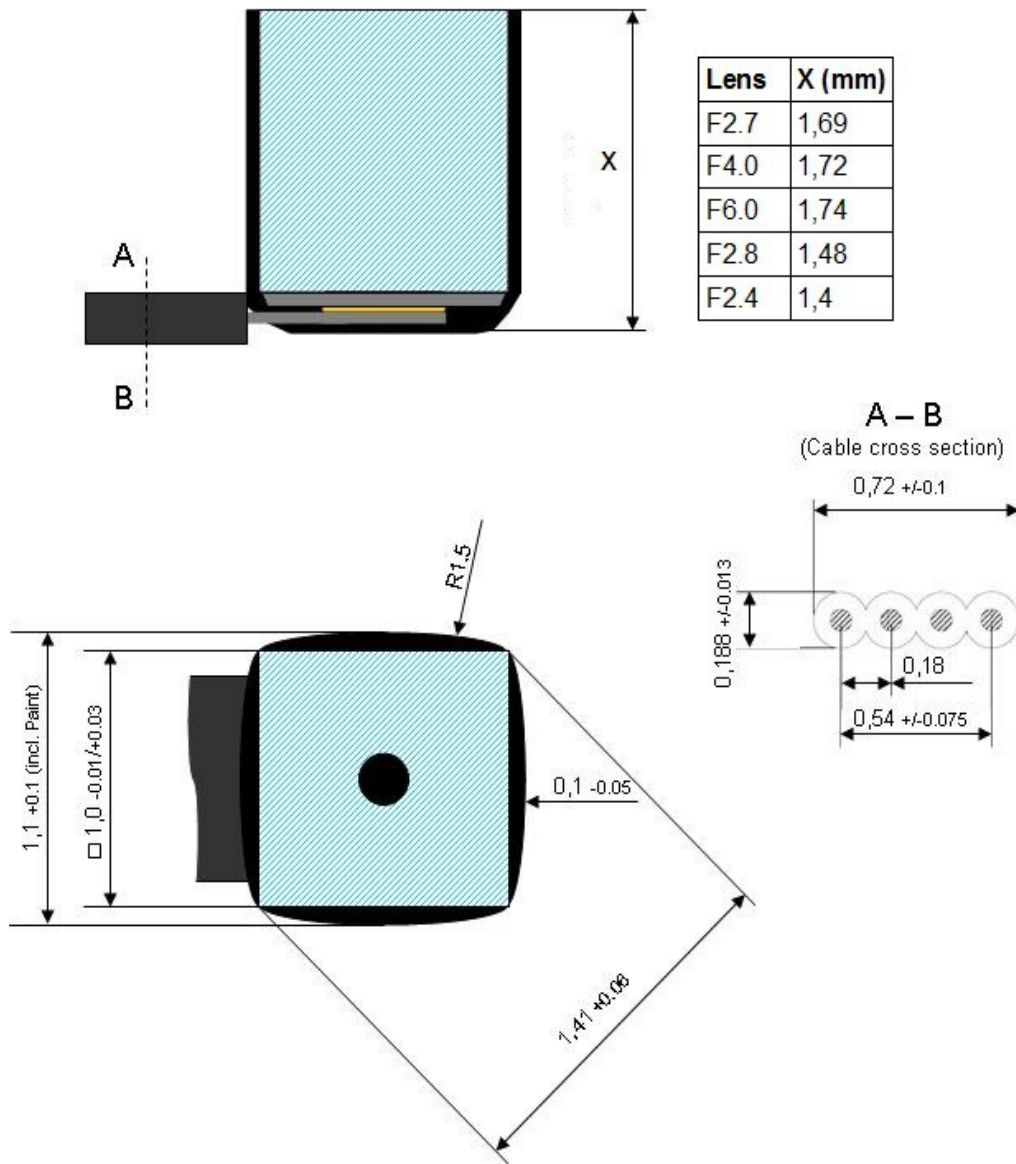

Figure 7: Measurements of the NANEYE module, Cable length may be adjusted to different lengths

3.3 NanEye Stereo

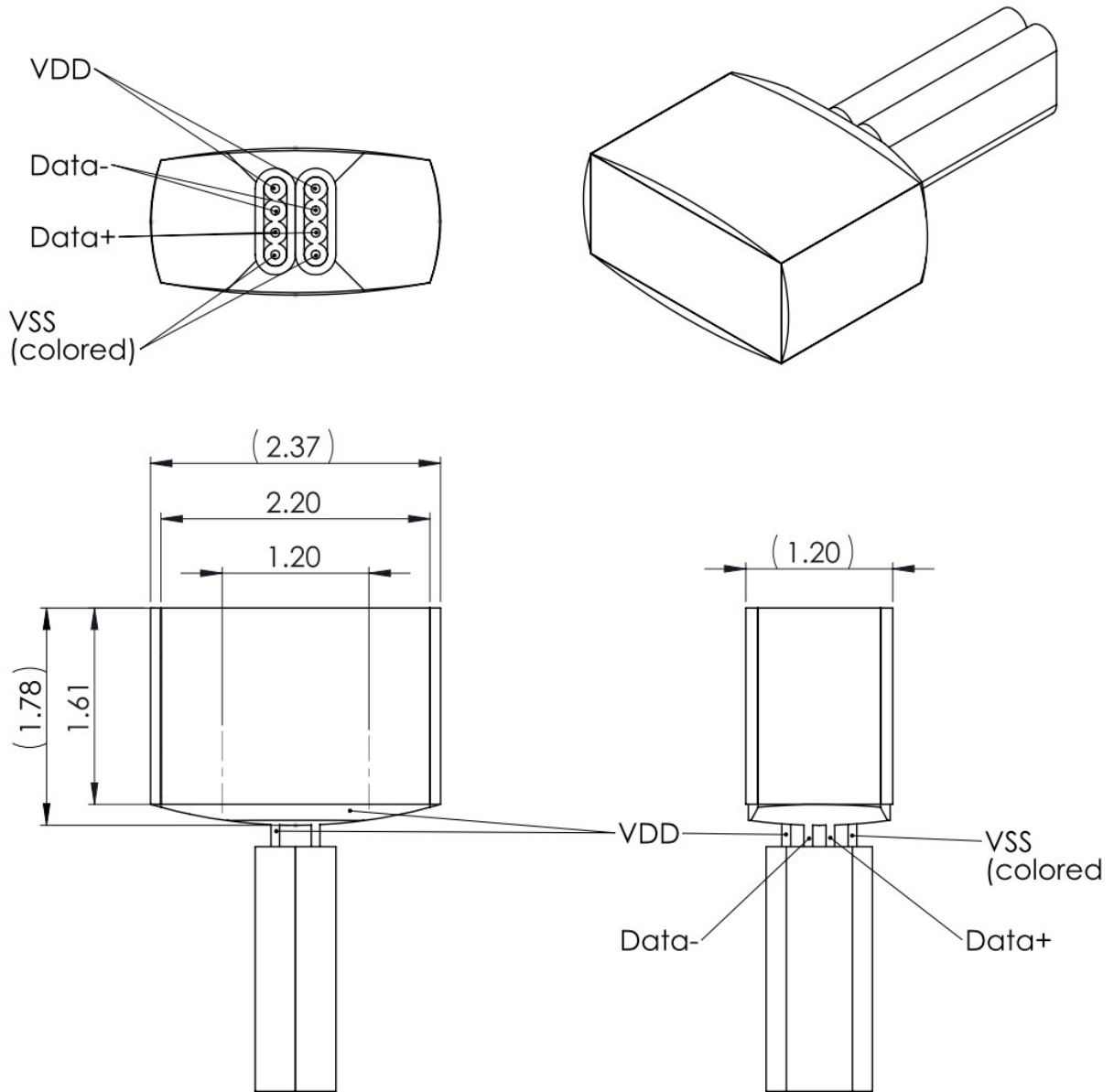

Figure 8: Measurements of the NanEye Stereo module (in mm)

4 Optic

The optional optics available for the sensor is a high performance miniature lens module. It will be directly mounted on the image sensor and has its best focus position defined by design, so no mechanical set of focus is needed. The material is based on B33 (Borofloat glass). The design is made in such way that the surface towards the object is flat, so the lens performance is not influenced by the medium between the object and lens. Only the opening angle of the lens is reduced when the system operates in water.



Evaluation set with Fiber Illumination

Different lens configurations are available.

	F#2.7 FOV90° [■]	F#4.0 FOV90°	F#6.0 FOV90°	F#2.8 FOV120°	F#4 FOV120°	F#2.4 FOV160°
F# Number	2.7	4.0	6.0	2.8	4	2.4
FOV (diagonal in air)	90° *	90°	90°	120°	120°	160°
FOV (diagonal in water)	62° *	62°	62°	86°	86°	95°
Max Distortion (diagonal in air)	23%	23%	23%	50%	50%	80%
Max Distortion (diagonal in water)	7.5%	7.5%	7.5%	16%	16%	20%
EFL (mm)	0.66	0.66	0.66	0.5	0.5	0.45
Aperture (um)	220	176	120	176	120	180
MTF @ Nyquist @ Center	25%	28%	30%	45%	45%	50%
MTF @ Nyquist @ 80% horizontal field	15%	18%	20%	15%	15%	12%
Best Focus (mm)	15	5	5	8	8	5
Depth of focus (mm)	5 – 40	3.5-30	3 – 50	4 – 40	3-50	4-50
Size (incl. image sensor, cover glass) (mm)	1 x 1 x 1.69 2.2 x 1.0 x 1.69 *	1 x 1 x 1.72	1 x 1 x 1.74	1 x 1 x 1.48	1 x 1 x 1.43	1 x 1 x 1.40

Table 1: Lens configuration

■ At the moment, we have available for NanEye Stereo the lens NanEye_FOV90_F2.7, *two times for NanEye Stereo, * For NanEye Stereo

The following image shows the CTF measures for different lens.

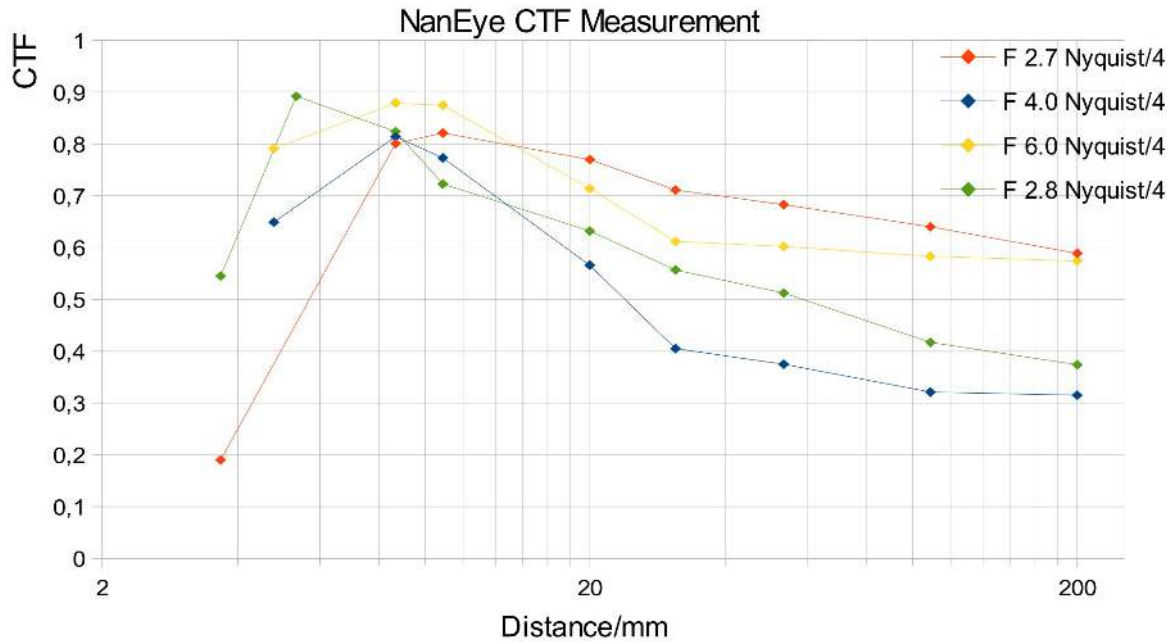

Figure 9: NanEye CTF measures

5 Evaluation Kit Content

Optionally with the camera, AWAIBA provides a base station and software to run the camera on a PC in real-time with all necessary image corrections. The complete system consist:

- NanEye and/or NanEye Stereo sensor head with optics
- 2m Optical fibre and 2m electrical cable mounted in single lumen
- USB Base station
- Fibre illumination source with SMA connector to POF fibre
- USB Cable
- Power adapter
- Windows software for display and store images

The Viewer Software has the following features:

- offset correction (Fix Pattern Noise correction)
- gain correction (PRNU correction)
- demosaic color reconstruction
- white balance
- brightness adjustment
- automatic exposure control (can be disabled)
- grab images
- storage of raw video files of any length
- enables external image processing
- sensor communication over the LVDS uplink for adjustment of exposure time and gain.

An **API** interface to the data stream is available for easy integration in existing display systems and evaluation of image processing algorithms.

5.1 How to Install Awaiba Viewer

Please take a look in Awaiba Viewer Quick Start file.

5.2 How to Start Awaiba Viewer

After installing the Awaiba Viewer Software and with the board connected to a PC, you can start the Viewer with the following option.

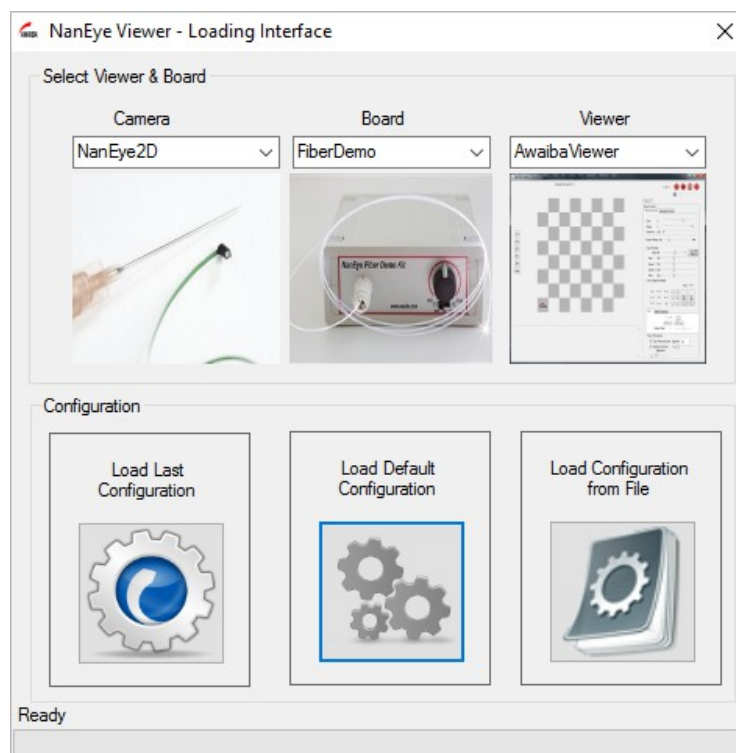

Figure 10: Starting the Viewer

5.3 How to Use Awaiba Viewer

Please take a look in NanEye - Awaiba Viewer file.

5.4 How to Debug

Afterwards installing Awaiba Viewer please take a look into C:\Program Files (x86)\Awaiba\Awaiba Viewer v2.16.2.3\application\debug where is the NanEye – Debug Manual.



Evaluation set with Fiber Illumination

For additional information or assistance please contact our technical support through support@awaiba.com.



Evaluation set with Fiber Illumination

6 Package Options

6.1 Nano Fiber Demo Kit

Sensor	NanEye	NanEye Stereo
Colour	B&W, RGB	B&W, RGB
Lens	F#2.7 FOV 90°	F#2.7 FOV 90°
	F#4.0 FOV 90°	
	F#6.0 FOV 90°	
	F#2.8 FOV 120°	
	F#4.0 FOV 120°	
	F#2.4 FOV 160°	



Evaluation set with Fiber Illumination

7 Disclaimer

The NanEye and NanEye Stereo evaluation set is intended solely for evaluation purposes of the sensors and camera modules. The use of the evaluation set for any medical purpose is strictly forbidden and AWAIBA therefore waves any responsibility for possible damage or harm.

The NanEye and NanEye Stereo system is NOT supplied sterile! Medical use of the system may lead to serious harm, illness or death!



Evaluation set with Fiber Illumination

End of Document