

ESD-FPD Series Split Cores with Metal Clamp for Flat Cables for High Frequency (Bare)

Overview

The KEMET ESD-FPD Series split cores are designed for use on flat cable. A wide range of Nickel Zinc (NiZn) options allow for targeting of specific high frequency ranges. Each product features two core parts and two stainless steel clamps.

EMI cores are part of a family of passive components which address the issues of noise or electromagnetic interference (EMI) in circuits or systems.

Applications

- Office equipment
- Home appliances
- Inkjet printers
- Consumer electronics
- Industrial equipment
- Test and measurement equipment
- Medical equipment
- Audio-visual equipment

Benefits

- NiZn \leq 300 MHz (FM band range) options available
- Split construction
- Easy to install through its clamp mechanism
- Quick solution for post-cable assembly noise issue
- Stainless steel clamp



Each part number includes two ferrite parts and two clamps, as shown in the picture.

Part Number System

ESD-	FPD-	16	
Series	Form Type	Applicable Cable	Clamp Type
ESD-	Split	xx = xx Core	Blank = Stainless steel clamp

Core Material and Effective Frequency Range

There are two ferrite material options for KEMET EMI Cores: Nickel-Zinc (NiZn) and Manganese Zinc (MnZn). Each core material has a different resistance and effective frequency range. The MnZn core material has a lower resistance compared to the NiZn; therefore, adequate insulation is required before use.

The NiZn core material is typically effective for frequencies in the MHz band range such as the FM-band, while the MnZn core material is typically effective for the kHz band range such as the AM-band. See Figure 1.

It is recommended to measure the actual frequency range effectiveness in the target application.

Figure 1 – Effective band range of Mn-Zn and Ni-Zn ferrite core material. (Representative example, measured with same-dimension ring core)

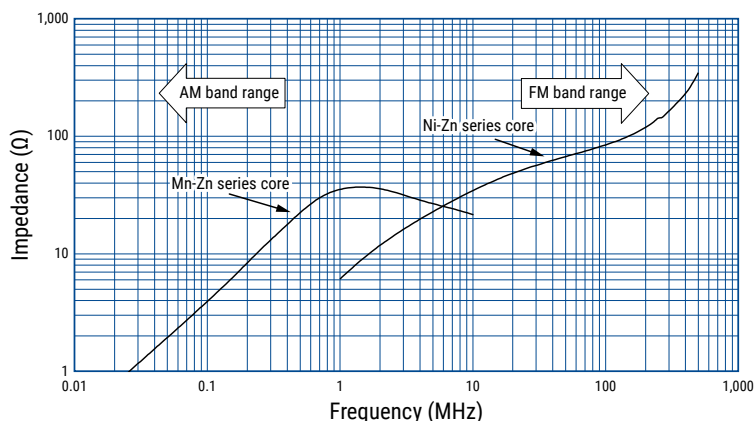

Environmental Compliance

All KEMET EMI cores are RoHS compliant.



Dimensions – Millimeters

Core

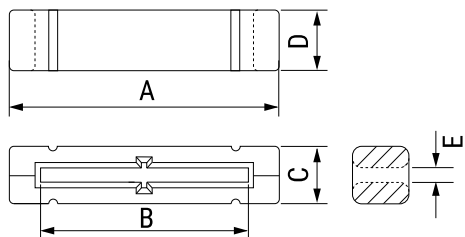

Clamp (Stainless Steel)

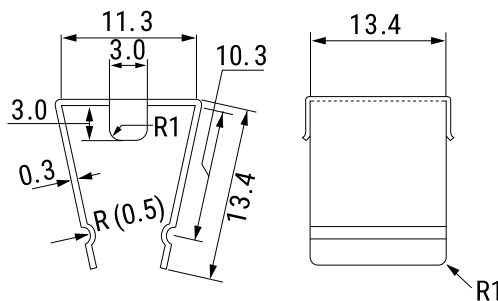

See Table 1 for dimensions

Magnetic Permeability of Ferrite Material

In order to achieve most efficient noise reduction, it is important to select the material according to the target frequency band. Depending on its magnetic permeability, a particular ferrite material will be effective in a certain frequency band. A schematic representation of the relationship between the magnetic permeability of each material and the corresponding effective band range is shown in Figure 1. Materials with higher magnetic permeability are effective in the lower frequency range, while those with lower magnetic permeability are effective in the higher frequency range. Thus, Mn-Zn products are mainly used for reducing conduction noise, while Ni-Zn products are commonly used for radiation noise countermeasures.

The effective frequency range varies depending on core shape, size and number of windings. This frequency dependence of the magnetic permeability as shown in the figure serves for reference purposes only and it should be tested on the actual device to determine its effectiveness.

S18H, S15H, 10H, 7H, 5H, 1400L and 700L are KEMET's proprietary ferrite material names. Other materials can also be available on request.

Figure 2 - Relationship between the magnetic permeability of each material and its effective frequency range

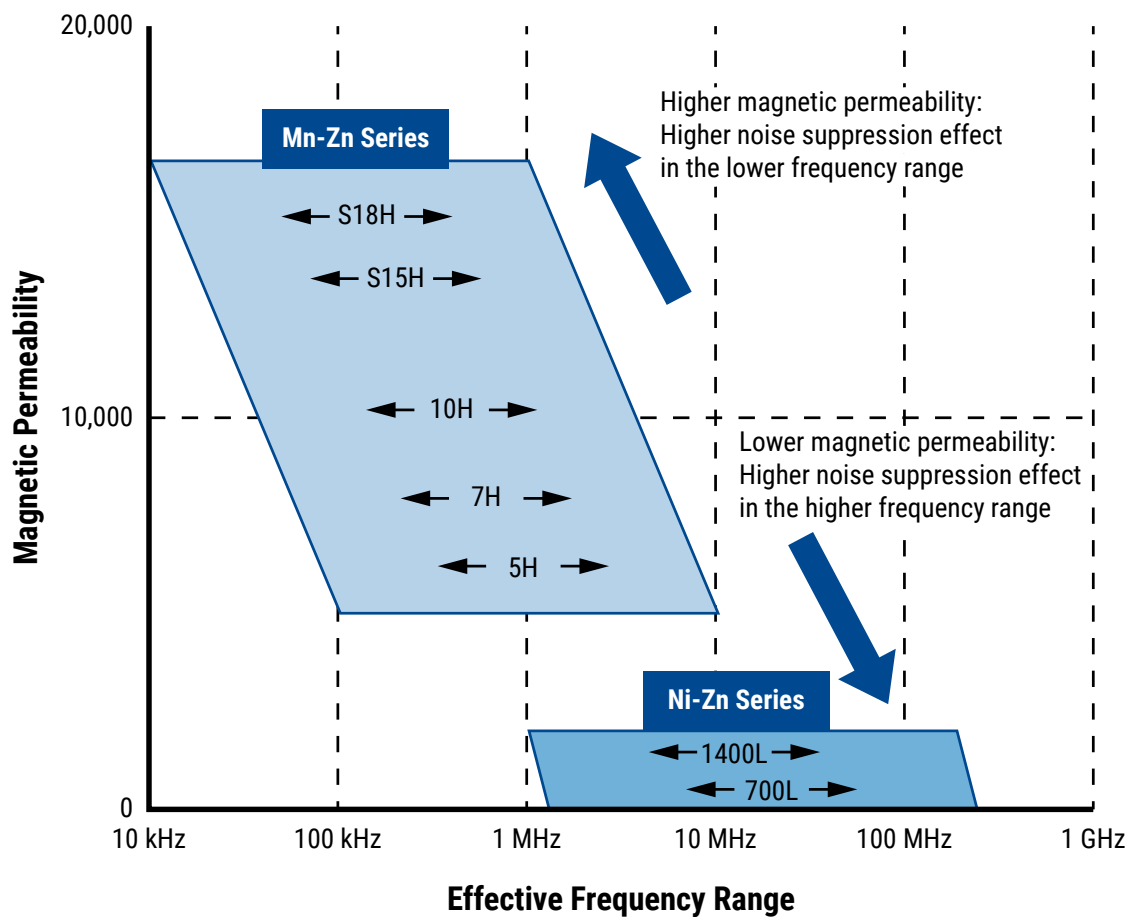

Installation Example

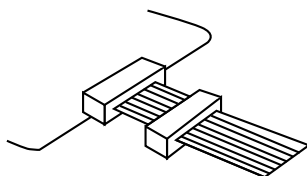

Performance Characteristics

Item	Performance Characteristics
Operating temperature	-25°C to +85°C
Frequency range	High frequency
Outer length	37.0 – 80.0 mm
Outer width	10.0 mm
Inner length	25.4 – 68.6 mm
Inner width	2.0 – 2.6 mm
Thickness	12.7 mm
Type	Bare with stainless steel clamp
Material	NiZn 700L

Table 1 – Ratings & Part Number Reference

Part Number	Dimensions (mm)					Weight (g)	Applicable Cable	Frequency Range ¹	Material	
	A	B	C	D	E			≤ 300 MHz (FM band range)	MnZN	NiZn
ESD-FPD-16	37.0 ±1.0	25.4 ±1.0	10.0 ±2.0	12.7 ±1.0	2.6 ±1.0	21.58	16 Core	X	-	700L
ESD-FPD-34	60.0 ±1.0	48.3 ±1.0	10.0 ±2.0	12.7 ±1.0	2.0 ±1.0	32.28	34 Core	X	-	700L
ESD-FPD-40	68.0 ±1.0	56.0 ±1.0	10.0 ±2.0	12.7 ±1.0	2.0 ±1.0	37.08	40 Core	X	-	700L
ESD-FPD-50	80.0 ±1.0	68.6 ±1.0	10.0 ±2.0	12.7 ±1.0	2.0 ±1.0	42.48	50 Core	X	-	700L

¹ Frequency range is for reference only. Please test with actual device before use.

Impedance vs. Frequency

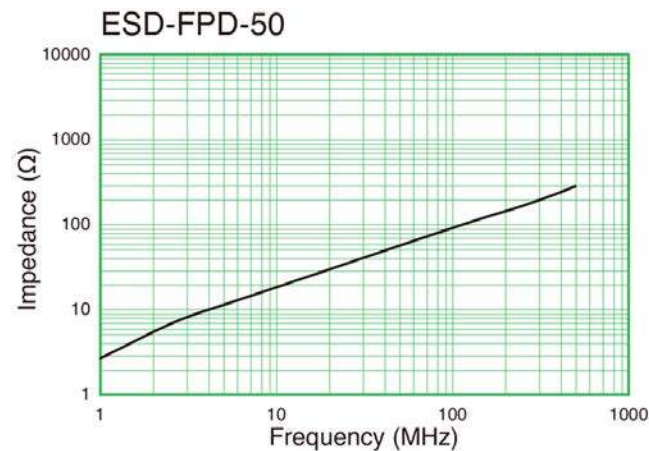
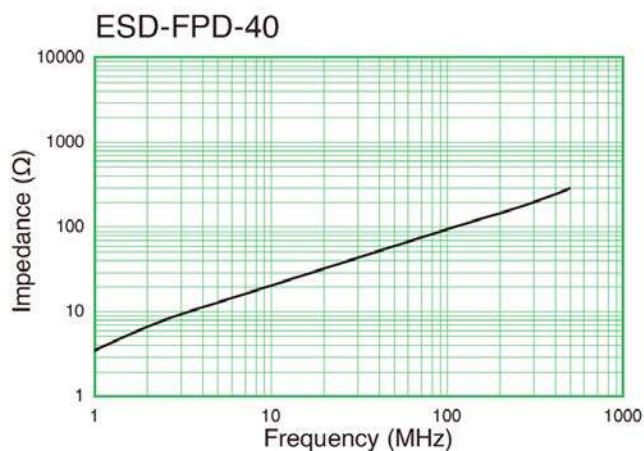
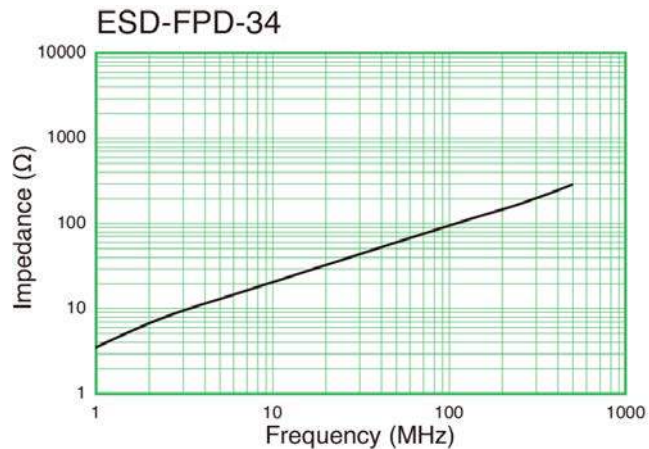
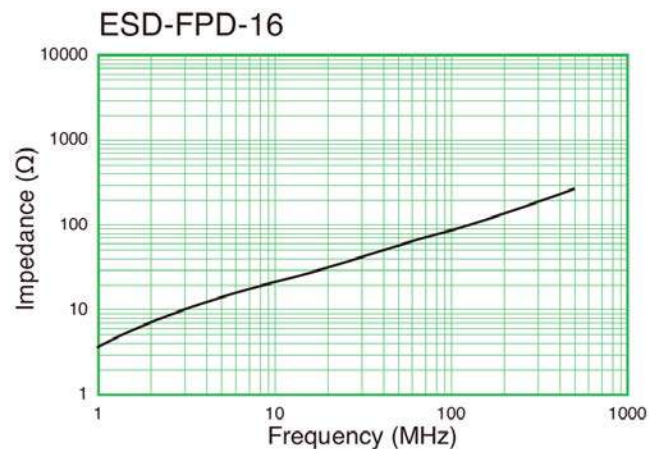

Packaging

Part Number	Packaging Type	Pieces per Box
ESD-FPD-16	Tray	800
ESD-FPD-34		250
ESD-FPD-40		240
ESD-FPD-50		

Handling Precautions

EMI Cores should be stored in normal working environments. While the EMI Cores themselves are quite robust in other environments, avoid exposure to high temperatures, high humidity, corrosive atmospheres and long term storage for case, snap-on and split types.

KEMET recommends that maximum storage temperature not exceed 40°C and maximum storage humidity not exceed 75% relative humidity. Atmospheres should be free of chlorine, sulfur and alkali bearing compounds. Avoid also storage near strong magnetic fields as this might magnetize the product.

Temperature fluctuations should be minimized to avoid condensation or cracks on the parts. Mechanical shocks can bring to cracks as well.

Export Control

For customers in Japan

For products that are controlled items subject to the “Foreign Exchange and Foreign Trade Law” of Japan, the export license specified by the law is required for export.

For customers outside Japan

EMI Core products should not be used or sold for use in the development, production, stockpiling or utilization of any conventional weapons or mass-destructive weapons (nuclear weapons, chemical or biological weapons, or missiles), or any other weapons.

KEMET Electronics Corporation Sales Offices

For a complete list of our global sales offices, please visit www.kemet.com/sales.

Disclaimer

All product specifications, statements, information and data (collectively, the "Information") in this datasheet are subject to change. The customer is responsible for checking and verifying the extent to which the Information contained in this publication is applicable to an order at the time the order is placed. All Information given herein is believed to be accurate and reliable, but it is presented without guarantee, warranty, or responsibility of any kind, expressed or implied.

Statements of suitability for certain applications are based on KEMET Electronics Corporation's ("KEMET") knowledge of typical operating conditions for such applications, but are not intended to constitute – and KEMET specifically disclaims – any warranty concerning suitability for a specific customer application or use. The Information is intended for use only by customers who have the requisite experience and capability to determine the correct products for their application. Any technical advice inferred from this Information or otherwise provided by KEMET with reference to the use of KEMET's products is given gratis, and KEMET assumes no obligation or liability for the advice given or results obtained.

Although KEMET designs and manufactures its products to the most stringent quality and safety standards, given the current state of the art, isolated component failures may still occur. Accordingly, customer applications which require a high degree of reliability or safety should employ suitable designs or other safeguards (such as installation of protective circuitry or redundancies) in order to ensure that the failure of an electrical component does not result in a risk of personal injury or property damage.

Although all product-related warnings, cautions and notes must be observed, the customer should not assume that all safety measures are indicated or that other measures may not be required.

When providing KEMET products and technologies contained herein to other countries, the customer must abide by the procedures and provisions stipulated in all applicable export laws and regulations, including without limitation the International Traffic in Arms Regulations (ITAR), the US Export Administration Regulations (EAR) and the Japan Foreign Exchange and Foreign Trade Act.

KEMET is a registered trademark of KEMET Electronics Corporation.