

# POB SERIES RF CO-AXIAL CONNECTORS

## INFORMATION

The POB (Push-on Lock Connectors Type B) series consists of high-performance small-size push-on lock coaxial connectors having original coupling parts which were developed for microwave-band use.

Mounting and removing can be performed in a shorter time than in the familiar HRM series of small-size coaxial connectors for microwave-band use. In addition, mounting and removing can be performed without using a torque wrench. Therefore, the mounting density can be increased.

By using the POB series, the adjusting time in sets can be shortened, the maintenance work can be speeded up, and the economical effect is displayed to the fullest.

## Uses

The POB series is suitable for in-unit wiring in wired and wireless communications equipment, broadcasting equipment, radar equipment and electronic measuring instruments, for connections between units, and for input/output terminals of equipment components.

In particular, they facilitate the complicated and high-density processing of in-unit wiring and the mounting and removing work in multi-stage unit coupling. Moreover, they are most suitable for sets in which it is necessary to ensure excellent transmission characteristics.

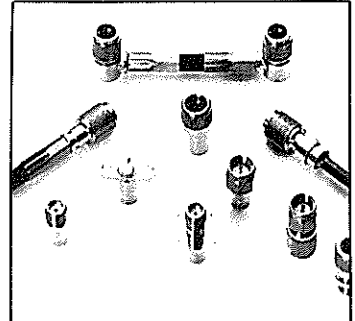

## Characteristic features

### 1. Good performance characteristics

The structure and dimensions of the transmission path and the structure in which the center contact and the dielectric materials are fastened have been unified between the POB series and the HRM series. Therefore, the POB series has high-frequency characteristics as good as those of the HRM series and mechanical characteristics as stable as those of the HRM series.

The coupling part also has a structure with an innovative spring function unit, which has been designed so that the electrical standard surfaces are always in contact, and an outer cylinder which protects the spring function unit and provides excellent protection, thus ensuring high stability and reliability.

### 2. Mounting and removal are easy.

There are the following advantages in mounting and removal in comparison with the HRM series, which is of the screw-lock type.

- (1) Mounting and removal does not take time and can be carried out almost instantaneously.
- (2) Even in a configuration like that of a U link, in which connectors are attached to both ends of a short semi-rigid cable, there is no need to go to the trouble of aligning the coupling depths of both sides when mounting and removing, as is necessary in the HRM series.
- (3) The structure used is a complete one in which both the center and outer contact springs are not damaged even if the cable is twisted when there is incomplete coupling.
- (4) Since mounting and removal can be performed with the fingers, there is no need to provide spanners or torque wrenches.

### 3. The mounting density can be raised.

The sizes and weights of the POB series are almost the same as those of the HRM series. However, the mounting density can be raised because, unlike the HRM series, torque wrenches are not used, when inserting or withdrawing the POB series.

### 4. The series is compatible with the HRM series.

The POB series has been given the greatest possible compatibility with the HRM series in the following points. Consequently, when changing over from the HRM series or combining both series, there are very few cases in which the set designs need to be changed, new connecting tools or standard work instruction manuals need to be provided, or guidance is required in the work of connecting the wiring.

- (1) The method of mounting on the set and the mounting dimensions
- (2) The size, weight and electrical length
- (3) Types of standard cables with which the series matches
- (4) Methods of connecting the wiring and connecting tools

# POB SERIES RF CO-AXIAL CONNECTORS

## Standard cables

The following are the standard cables of the POB series:

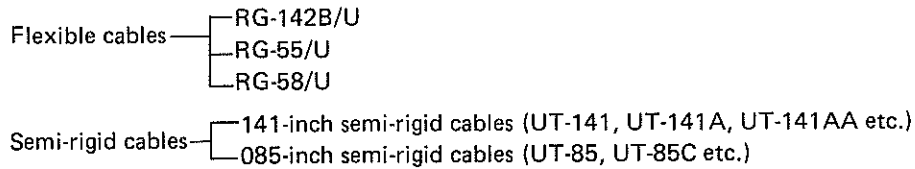

The dimensions of the standard cables are listed on P.139.

## Types

The POB series is classified into the following types:

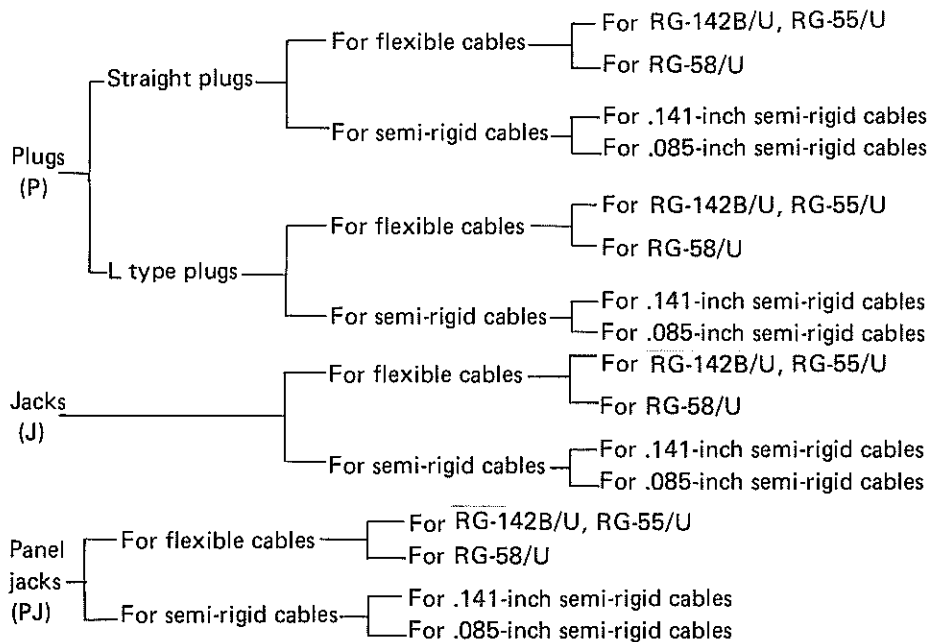

\*One product can be shared.

Receptacles (R) — Various types

Plug receptacles (RP) — Various types

Adapters (A•PA•LA) — Various types

Conversion adapters — Various types

Dummy loads (TMP) — Plug dummy loads, jack dummy loads

The names of the types have the following configurations:

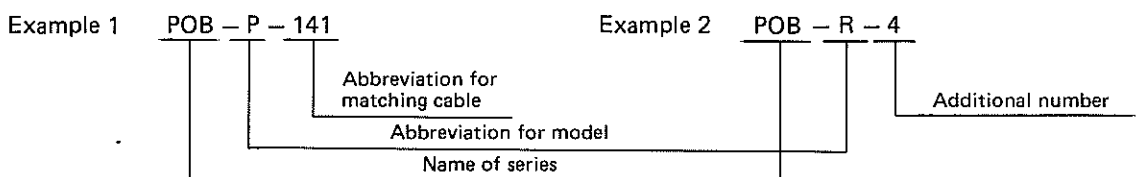

# POB SERIES RF CO-AXIAL CONNECTORS

## Main materials used

Parts	Materials		Finish	
	Materials	Applicable standards	Plating	Plating thickness
Shell	Brass	JIS H 3250	Gold plating	0.5 ~ 1 micron
Outer cylinder	Brass	JIS H 3250	Nickel plating	3 microns
Female contact	Beryllium copper	JIS H 3270	Gold plating	2 ~ 3 microns
Male contact	Brass	JIS H 3250	Gold plating	2 ~ 3 microns
Solderless sleeve (ferrule)	Annealed copper		Nickel plating	3 microns
Insulation	Tetrafluoride resin			
Cord covering	Fluororesin			

## Coupling parts

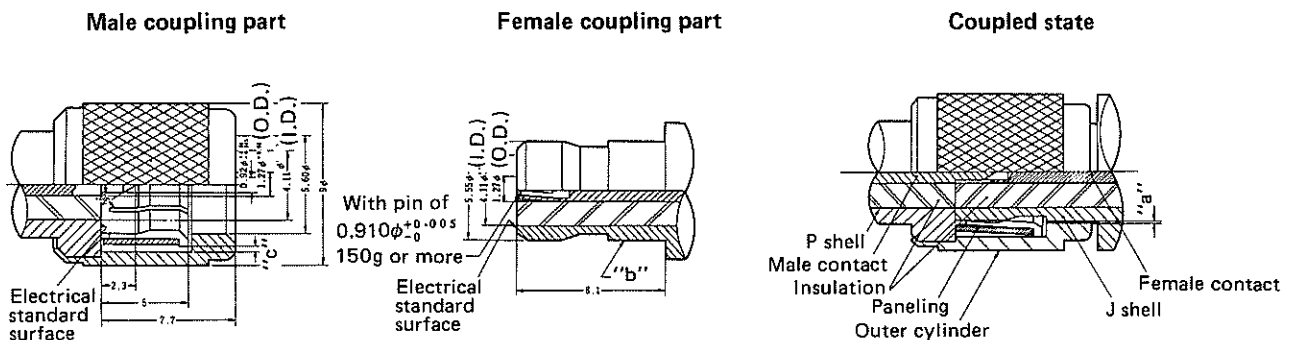

### Explanation 1:

The dimensions of the transmission path (the inner and outer diameters of the center contact and the inner diameter of the shell with the insulation inserted) are the same as those of the HRM series.

### Explanation 2:

Tapered parts are provided on the spring part of the male coupling part and on the outer diameter part of the female coupling part. Therefore, the spring force is dispersed in the radial and axial directions, where it operates as the coupling force and as the top touch force on the electrical standard surface, respectively.

### Explanation 3:

Gap "a" between the inner diameter of the outer cylinder and the outer diameter of the J shell is 0.05mm or less, and its moving angle is suppressed to 23 minutes or less in order to minimize to the utmost the load applied to the contact spring (both the center and outer) even if the cable is twisted in the coupled state.

### Explanation 4:

The dimensions are planned so that the center contacts will not couple together unless part "b" (5.55φ) of the J shell is inserted into the outer cylinder (with the exception of the tapered part of the male contact). Therefore, the center contact springs will not be damaged even if the cable is twisted when the coupling state is imperfect. Moreover, since the gap "c" between the P shell and the outer cylinder is set at 0.2 ~ 0.3 mm and the movable distance of the spring part is suppressed, the outer contact spring will not be damaged.

# POB SERIES RF CO-AXIAL CONNECTORS

## Performance characteristics

Items		Performance characteristics									
Structure, dimensions	Structure	Refer to individual drawings									
	Dimensions	Dimension of coupling parts: see P.128. External dimensions: see P.130~136.									
Electrical characteristics	Insulation resistance	5000MΩ or more measured at 500V DC									
	Withstand voltage	Test voltage 1000V AC (rms) (at normal pressure)									
	Contact resistance	4mΩ or less at both center contact and outer contact									
	Characteristic impedance	50Ω									
	Frequency range	DC ~ 12.4GHz									
	Voltage standing wave ratio (V.S.W.R.)	Connector for .141-inch semi-rigid cables	<table border="0"> <tr> <td rowspan="2">┌</td> <td>Straight type</td> <td>DC ~ 6GHz, 1.15 or less</td> <td>6 ~ 12.4GHz, 1.2 or less</td> </tr> <tr> <td>L-bent type</td> <td>DC ~ 6GHz, 1.2 or less</td> <td>6 ~ 12.4GHz, 1.25 or less</td> </tr> </table>	┌	Straight type	DC ~ 6GHz, 1.15 or less	6 ~ 12.4GHz, 1.2 or less	L-bent type	DC ~ 6GHz, 1.2 or less	6 ~ 12.4GHz, 1.25 or less	
		┌	Straight type		DC ~ 6GHz, 1.15 or less	6 ~ 12.4GHz, 1.2 or less					
			L-bent type	DC ~ 6GHz, 1.2 or less	6 ~ 12.4GHz, 1.25 or less						
		Connectors for flexible cables	<table border="0"> <tr> <td rowspan="2">┌</td> <td>Straight type</td> <td>DC ~ 4GHz, 1.25 or less</td> <td>4 ~ 6GHz, 1.3 or less</td> </tr> <tr> <td>L-bent type</td> <td>DC ~ 4GHz, 1.25 or less</td> <td>4 ~ 6GHz, 1.3 or less</td> </tr> </table> <p>Note) Values for cases where the cables are RG-142B/U.</p>	┌	Straight type	DC ~ 4GHz, 1.25 or less	4 ~ 6GHz, 1.3 or less	L-bent type	DC ~ 4GHz, 1.25 or less	4 ~ 6GHz, 1.3 or less	
		┌	Straight type		DC ~ 4GHz, 1.25 or less	4 ~ 6GHz, 1.3 or less					
L-bent type			DC ~ 4GHz, 1.25 or less	4 ~ 6GHz, 1.3 or less							
Receptacles	<table border="0"> <tr> <td rowspan="2">┌</td> <td>Straight type</td> <td>DC ~ 6GHz, 1.15 or less</td> <td>6 ~ 12.4GHz, 1.2 or less</td> </tr> <tr> <td>L-bent type</td> <td>DC ~ 6GHz, 1.2 or less</td> <td>6 ~ 12.4GHz, 1.25 or less</td> </tr> </table>	┌	Straight type	DC ~ 6GHz, 1.15 or less	6 ~ 12.4GHz, 1.2 or less	L-bent type	DC ~ 6GHz, 1.2 or less	6 ~ 12.4GHz, 1.25 or less			
┌	Straight type		DC ~ 6GHz, 1.15 or less	6 ~ 12.4GHz, 1.2 or less							
	L-bent type	DC ~ 6GHz, 1.2 or less	6 ~ 12.4GHz, 1.25 or less								
Plug receptacles	<table border="0"> <tr> <td rowspan="2">┌</td> <td>Straight type</td> <td>DC ~ 6GHz, 1.15 or less</td> <td>6 ~ 12.4GHz, 1.2 or less</td> </tr> <tr> <td>L-bent type</td> <td>DC ~ 6GHz, 1.2 or less</td> <td>6 ~ 12.4GHz, 1.25 or less</td> </tr> </table>	┌	Straight type	DC ~ 6GHz, 1.15 or less	6 ~ 12.4GHz, 1.2 or less	L-bent type	DC ~ 6GHz, 1.2 or less	6 ~ 12.4GHz, 1.25 or less			
┌	Straight type		DC ~ 6GHz, 1.15 or less	6 ~ 12.4GHz, 1.2 or less							
	L-bent type	DC ~ 6GHz, 1.2 or less	6 ~ 12.4GHz, 1.25 or less								
Adapters	<table border="0"> <tr> <td rowspan="3">┌</td> <td>Straight type</td> <td>DC ~ 6GHz, 1.15 or less</td> <td>6 ~ 12.4GHz, 1.2 or less</td> </tr> <tr> <td>L-bent type</td> <td>DC ~ 6GHz, 1.2 or less</td> <td>6 ~ 12.4GHz, 1.25 or less</td> </tr> <tr> <td>Conversion adapters</td> <td>DC ~ 6GHz, 1.15 or less</td> <td>6 ~ 12.4GHz, 1.2 or less</td> </tr> </table>	┌	Straight type	DC ~ 6GHz, 1.15 or less	6 ~ 12.4GHz, 1.2 or less	L-bent type	DC ~ 6GHz, 1.2 or less	6 ~ 12.4GHz, 1.25 or less	Conversion adapters	DC ~ 6GHz, 1.15 or less	6 ~ 12.4GHz, 1.2 or less
┌	Straight type		DC ~ 6GHz, 1.15 or less	6 ~ 12.4GHz, 1.2 or less							
	L-bent type		DC ~ 6GHz, 1.2 or less	6 ~ 12.4GHz, 1.25 or less							
	Conversion adapters	DC ~ 6GHz, 1.15 or less	6 ~ 12.4GHz, 1.2 or less								
Dummy loads	DC ~ 6GHz, 1.1 or less    6 ~ 12.4GHz, 1.15 or less										
Mechanical characteristics	Coupling force (Withdrawing force)	2 ~ 6kg in state where units are actually coupled to each other									
	Center contact holding force	150g or more with steel pin gauge of $0.915\phi_{-0}^{+0.005}$									
	Center contact fastening torque	170g-cm or more									
	Service life	500 times									
Environmental properties	Vibration resistance	Current tripped in 2 microseconds or less when tested by the method of JIS C5025, Type I-B.									
	Impact resistance	There must be no abnormalities when tested by MIL-STD-202, Method 107D, test condition B.									
	Humidity resistance	There must be no abnormalities when tested by the method of JIS C5024 Type A.									
	Corrosion resistance	There must be no abnormalities when tested by the method of JIS C5028.									

# POB SERIES RF CO-AXIAL CONNECTORS

## Guide to products

The following are the typical products in the POB series. We also accept orders for designing and production according to special specifications. Client orders are invited.

## Connectors for semi-rigid cables

The connectors for semi-rigid cables match two types of cables: .141-inch and .085-inch semi-rigid cables. .141-inch cables should be used in order to obtain the V.S.W.R. listed on P.129. .085-inch cables, which have good flexibility, are suitable in cases where the wiring is laid with a high density inside the set. In this case, the V.S.W.R. value will be higher than that of the .141-inch cables.

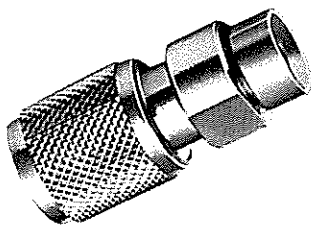

HRS No.	Part No.
* CL326-0001-0-40	POB-P-141(40)
CL326-0002-3-40	POB-P-85(40)

### Plugs

- 141: for .141-inch semi-rigid cables
- 85: for .085-inch semi-rigid cables

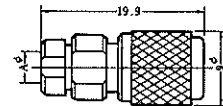
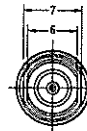

Part No.	A φ
POB-P-141(40)	3.63
POB-P-85(40)	2.25

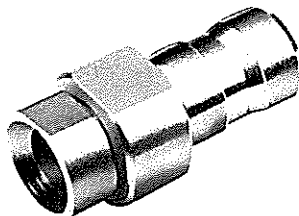

HRS No.	Part No.
CL326-0003-6-40	POB-J-141(40)

### Jacks

- 141: for .141-inch semi-rigid cables
- 85: for .085-inch semi-rigid cables

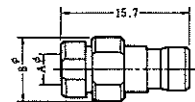
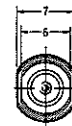

Part No.	A φ
POB-J-141(40)	3.63

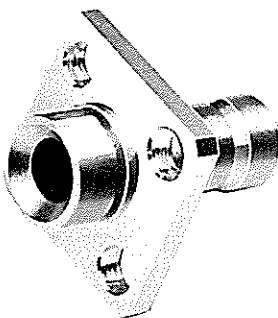

HRS No.	Part No.
* CL326-0005-1-40	POB-PJ-141(40)
CL326-0006-4-40	POB-PJ-85(40)

### Panel jacks

- 141: for .141-inch semi-rigid cables
- 85: for .085-inch semi-rigid cables

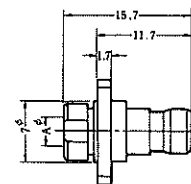
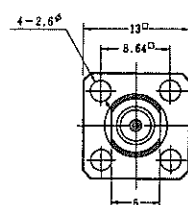

Part No.	A φ
POB-PJ-141(40)	3.63
POB-PJ-85(40)	2.25

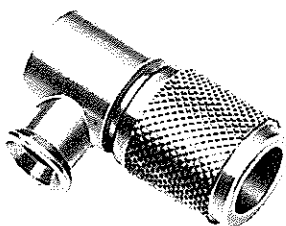

HRS No.	Part No.
CL326-0007-7-40	POB-LP-141(40)
CL326-0008-0-40	POB-LP-85(40)

### L-type plugs

- 141: for .141-inch semi-rigid cables
- 85: for .085-inch semi-rigid cables

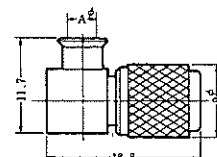

Part No.	A φ
POB-LP-141(40)	3.63
POB-LP-85(40)	2.25

# POB SERIES RF CO-AXIAL CONNECTORS

## Connectors for flexible cables

Connectors for flexible cables include those which match RG-55/u, RG-142B/u and those which match RG-58/u.

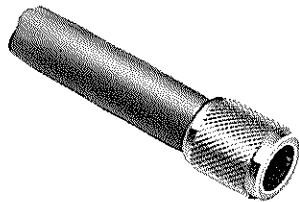

HRS No.	Part No.
* CL326-0022-0	POB-P-55/U
* CL326-0021-8	POB-P-58/U

**Plugs**

-55/u: For RG-55/u, RG-142B/u

-58/u: For RG-58/u

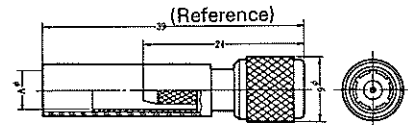

Part No.	Aφ
POB-P-55/u	5.8
POB-P-58/u	5.1

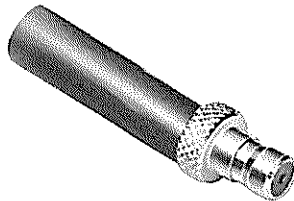

HRS No.	Part No.
CL326-0024-6	POB-J-55/U
CL326-0023-3	POB-J-58/U

**Jacks**

-55/u: For RG-55/u, RG-142B/u

-58/u: For RG-58/u

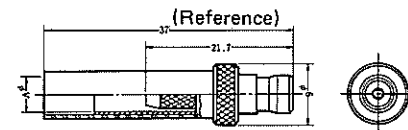

Part No.	Aφ
POB-J-55/u	5.8
POB-J-58/u	5.1

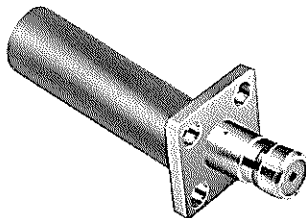

HRS No.	Part No.
CL326-0026-1	POB-PJ-55/U

**Panel jacks**

-55/u: For RG-55/u, RG-142B/u

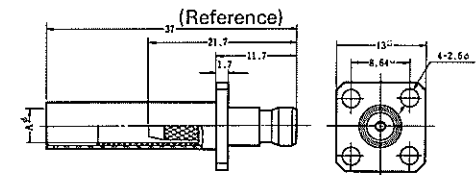

Part No.	Aφ
POB-PJ-55/U	φ 5.8

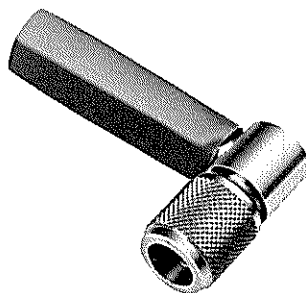

HRS No.	Part No.
* CL326-0028-7	POB-LP-55/U
* CL326-0027-4	POB-LP-58/U

**L-type plugs**

-55/u: For RG-55/u, RG-142B/u

-58/u: For RG-58/u

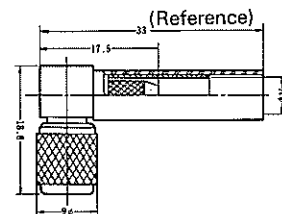

Part No.	Aφ
POB-LP-55/u	5.8
POB-LP-58/u	5.1

# POB SERIES RF CO-AXIAL CONNECTORS

## Receptacles

There are the following types of receptacle products. The dimensions for mounting them on the sets have been made compatible with the HRM series.

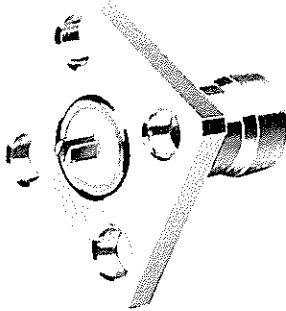

HRS No.	Part No.
CL326-0041-5-40	POB-R-4(40)

Fastened with machine screws  
at four places  
Slitter terminals  
Straight receptacles

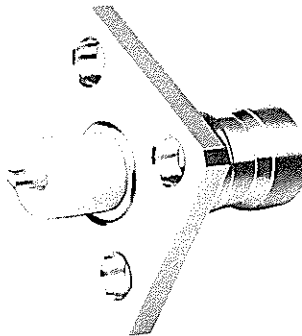
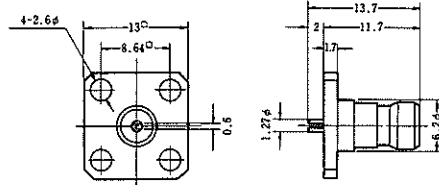

HRS No.	Part No.
CL326-0042-8-40	POB-R-6(40)

Fastened with machine screws  
at four places  
Half-cutter terminals  
Straight receptacles

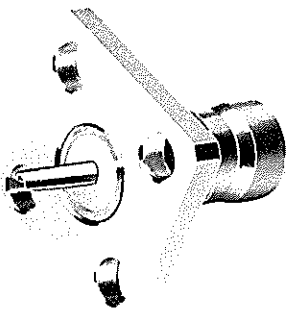
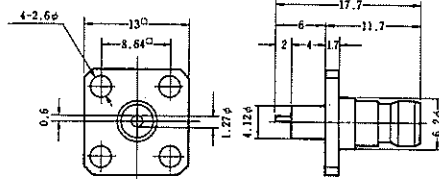

HRS No.	Part No.
CL326-0044-3-40	POB-R-15(40)

Fastened with machine screws  
at four places  
Solder terminals  
Straight receptacles

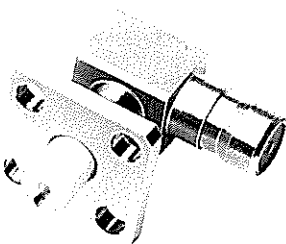
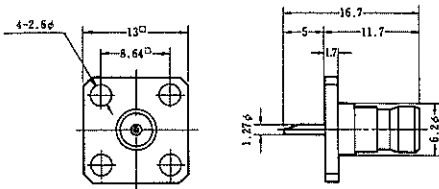

HRS No.	Part No.
CL326-0043-0-40	POB-LR-5(40)

Fastened with machine screws  
at four places  
Half cutter terminals  
L-type receptacles

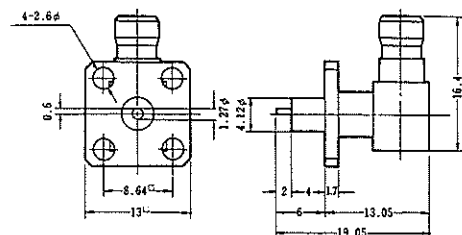

# POB SERIES RF CO-AXIAL CONNECTORS

## Plug receptacles

There are the following types of plug receptacle products. The dimensions for mounting them on the sets have been made compatible with the HRM series.

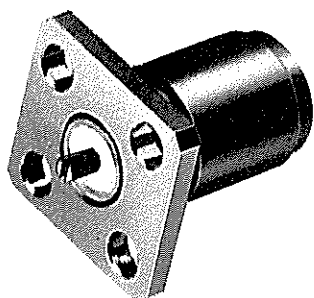

HRS No.	Part No.
CL326-0061-2-40	POB-RP-4(40)

Fastened with machine screws  
at four places  
Slitter terminals  
Straight receptacles

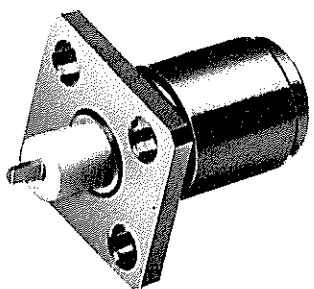
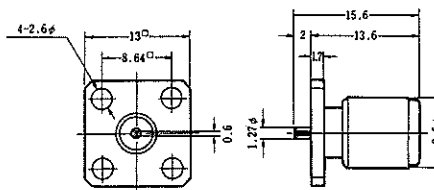

HRS No.	Part No.
CL326-0062-5-40	POB-PR-6(40)

Fastened with machine screws  
at four places  
Half-cutter terminals  
Straight receptacles

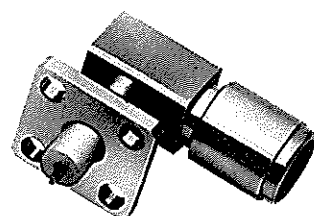
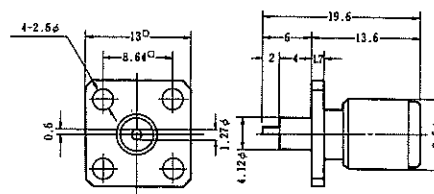

HRS No.	Part No.
CL326-0063-8-40	POB-LRP-5(40)

Fastened with machine screws  
at four places  
Half-cutter terminals  
L-type receptacles

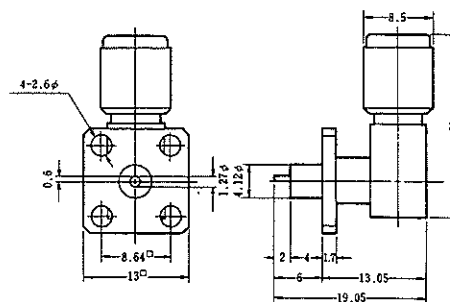



# POB SERIES RF CO-AXIAL CONNECTORS

## Adapters

There are the following adapters for connecting between coupling parts of the POB series:

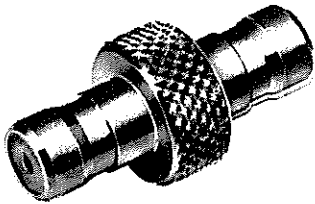

HRS No.	Part No.
CL326-0083-5-40	POB-A-JJ(40)

Female-female adapter

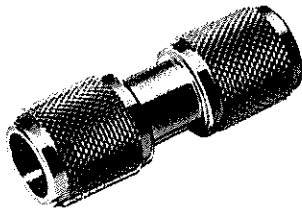
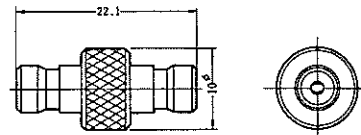

HRS No.	Part No.
CL326-0084-8-40	POB-A-PP(40)

Male-male adapter

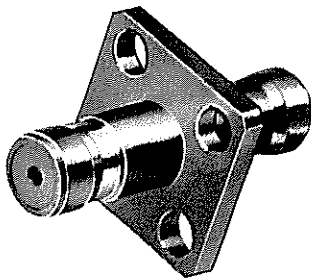
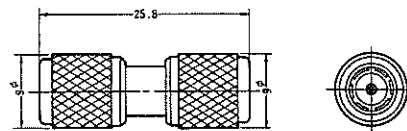

HRS No.	Part No.
CL326-0085-0-40	POB-PA-JJ(40)

Female-female panel adapter

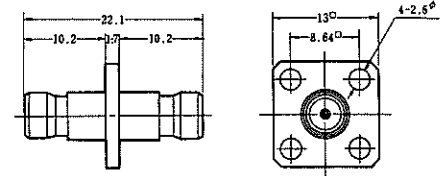

# POB SERIES RF CO-AXIAL CONNECTORS

## Convesion adapters

For converter adapters for connecting the POB series to HRM series, see the CL311 BWA series.

## Accessories

As accessories, there are two dummy loads for the male and female coupling parts.

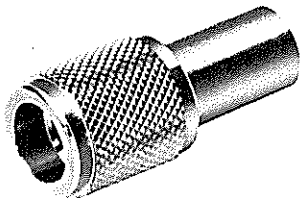

HRS No.	Part No.
CL353-0020-8-40	POB-TMP-025(40)

Male coupling part dummy load

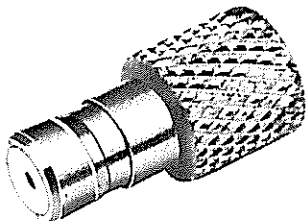
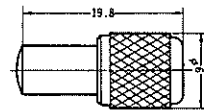

HRS No.	Part No.
CL353-0021-0-40	POB-TMJ-025(40)

Female coupling part dummy load

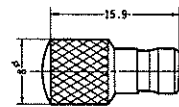

# POB SERIES RF CO-AXIAL CONNECTORS

## TECHNICAL GUIDANCE

### Twisting and changes of the V.S.W.R.

When push-on lock connectors are used in the microwave band, the item which requires greatest attention is whether the high-frequency characteristics will change if the connectors or cables are twisted in the coupled state. In the POB series, there is almost no change of the V.S.W.R. because the moving angle is suppressed to 23 minutes or less on one side even if twisting occurs, as is described on P.128. Exactly the same applies, naturally, in the original state even after 2000 insertions and withdrawals, which amounts to four times the guaranteed number of insertions and withdrawals.

### Number of insertions and withdrawals and deterioration of performance characteristics

#### 1. Deterioration of V.S.W.R.

The graph below gives typical data on the V.S.W.R. for the original state and when measured after 2000 insertions and withdrawals with twisting. There are almost no differences between the two pairs of data; this proves that deterioration of the V.S.W.R. has not occurred as a result of insertion and withdrawal.

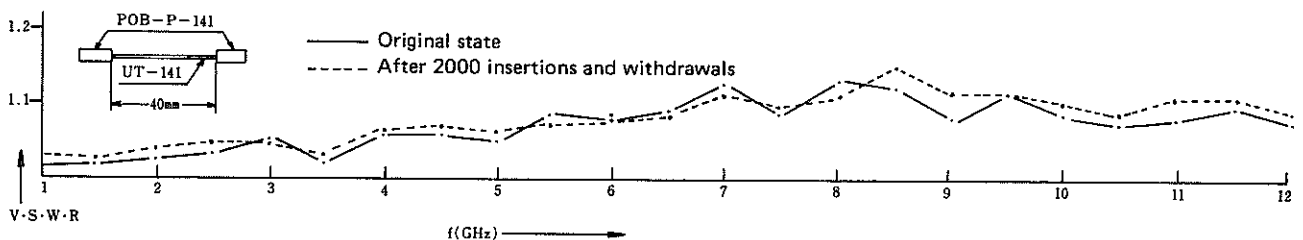

#### 2. Deterioration of coupling force

The graph below shows the deterioration of the coupling force (withdrawal force) caused by insertion and withdrawal. The deterioration is expressed in terms of an exponent, with the average value of 17 samples as the parameter. By the time of the first 100 insertions and withdrawals, the coupling force decreases rapidly to 60% of its initial value. This is because the internal stress is removed within this period and the male and female coupling parts become "used" to each other. After that, the deterioration changes to the usual type of deterioration caused by fatigue of the spring parts and tends towards stable and leisurely deterioration. The failure ratio during the first 100 times is larger in samples with a stronger initial coupling force. Consequently, it is not the case that in products having an initial coupling force near the lower limit of the guaranteed range the coupling force will be halved after 500 insertions and withdrawals.

### Relationship between insertion force and withdrawal force

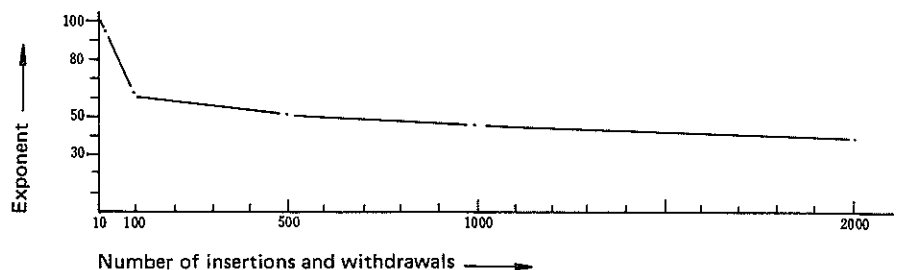

The coupling force can be divided into the insertion force and the withdrawal force. In the POB series, the withdrawal force is stronger than the insertion force by 40% (maximum), 10% (minimum) or 25% (average) (values using typical data).

# POB SERIES RF CO-AXIAL CONNECTORS

## Dimensions for mounting onto the set

### 1. When the connector flange is mounted on the outside of the set

#### (1) When mounted with plain hole

**Drawing of mounting**

**Dimensions of hole drilled in panel**

**Parts for mounting**

Part name	Type	Length (ℓ)
Machine screw	M2.3 × 0.4 pan-headed small screw or round small screw	t + 4.7mm or more* <sup>2</sup>
Nut	For M2.3 × 0.4	—
Spring washer	For M2.3	—
Flat washer* <sup>1</sup>	For M2.3	—

\*<sup>1</sup> Mount between nut and panel when it is wished to prevent peeling of the panel coating.  
\*<sup>2</sup> The length will be t + 5.2mm or more when a flat washer is used.

#### (2) When mounted with tap hole

**Drawing of mounting**

**Dimensions of hole drilled in panel**

**Parts for mounting**

Parts	Type	Length (ℓ)
Machine screw	M2.3 × 0.4 pan-headed small screw or round small screw	Depends on set design
Spring washer	For M2.3	—

#### List of Aφ dimensions (common to both (1) and (2))

Aφ (mm)	Applicable products
4.17 or more	POB-R-6, POB-RP-6, POB-LR-5, POB-LRP-5
5.55 or more	POB-PA-JJ HRMJ-POBJ-PA (when the HRM side is on the outside)
6.35 or more	HRMJ-POBJ-PA (when the POB side is on the outside)
7.15 or more	POB-PJ-141, POB-PJ-85
8 or more	POB-PJ-55/U, POB-PJ-58/U
Depends on set design	POB-R-4, POB-RP-4, POB-R-15, POB-RP-15

# POB SERIES RF CO-AXIAL CONNECTORS

## 2. When the connector flange is mounted on the inside of the set

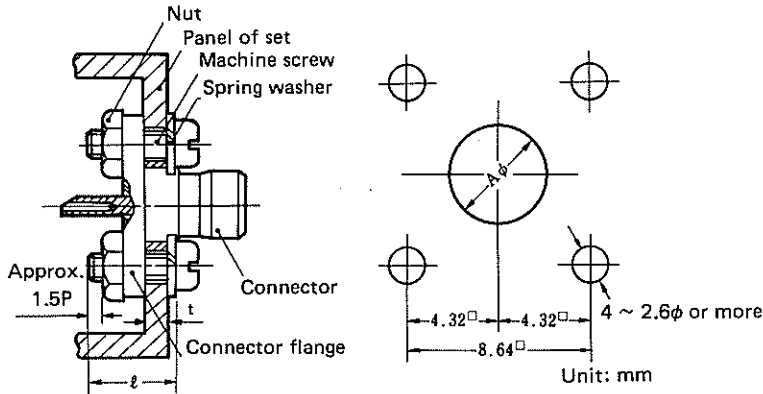

List of maximum panel thicknesses

t (mm)	Applicable products
1.8	POB-PJ-141, POB-PJ-85, POB-PJ-55/U, POB-PJ-58/U, POB-R-4, POB-R-6, POB-R-15
2.0	POB-PA-JJ HRMJ-POBJ-PA (when the HRM side is on the outside)
6.2	HRMJ-POBJ-PA (when the POB side is on the outside)

Parts for mounting

Part name	Type	Length (ℓ)
Machine screw	M2.3 x 0.4 Pan-headed small screw or round small screw	t + 4.7mm or more*2
Nut	For M2.3 x 0.4	—
Spring washer	For M2.3	—
Flat washer*1	For M2.3	—

\*1 Mount between flange and panel when it is wished to prevent peeling of the panel coating.  
\*2 The length will be t + 5.2 mm or more when a flat washer is used.

List of Aφ dimensions

Aφ (mm)	Applicable products
5.55 or more	POB-PA-JJ HRMJ-POBJ-PA (when the POB side is on the outside)
6.35 or more	POB-R-4, POB-R-6, POB-R-15, HRMJ-POBJ-PA (when the HRM side is on the outside)
7.65 or more	POB-PJ-141, POB-PJ-85, POB-PJ-55/U, POB-PJ-58/U
Impossible to mount	POB-LR-5, POB-LRP-5, POB-RP-4, POB-RP-6, POB-RP-15

## Standard Cables

Following are the dimensions, structures and materials of standard cables for the POB series:

Semi-rigid cables	Flexible cables																																										
<p>Center conductor (silver-plated copper-covered steel wire) Dielectric material (fluororesin) Outer conductor (copper tube)</p>	<p>Center conductor (copper wire or silver-plated copper-covered steel wire) Dielectric materials (polyethylene or fluororesin) Outer conductor (copper wire or silver-plated copper wire) Outer covering (PVC or fluororesin)</p>																																										
<table border="1" style="width: 100%; border-collapse: collapse;"> <thead> <tr> <th>Cable name</th> <th>Aφ</th> <th>Bφ</th> <th>Cφ</th> </tr> </thead> <tbody> <tr> <td>.141-inch semi-rigid cables</td> <td>0.912φ</td> <td>2.946φ<sup>±0.025</sup> ~3.01φ<sup>±0.025</sup></td> <td>3.581φ<sup>±0.025</sup></td> </tr> <tr> <td>.085-inch semi-rigid cables</td> <td>0.511φ</td> <td>1.671φ<sup>±0.0025</sup></td> <td>2.197φ<sup>±0.025</sup></td> </tr> </tbody> </table> <p style="text-align: right;">Unit: mm</p>	Cable name	Aφ	Bφ	Cφ	.141-inch semi-rigid cables	0.912φ	2.946φ <sup>±0.025</sup> ~3.01φ <sup>±0.025</sup>	3.581φ <sup>±0.025</sup>	.085-inch semi-rigid cables	0.511φ	1.671φ <sup>±0.0025</sup>	2.197φ <sup>±0.025</sup>	<table border="1" style="width: 100%; border-collapse: collapse;"> <thead> <tr> <th colspan="5" style="text-align: right;">Unit: mm</th> </tr> <tr> <th>Cable name</th> <th>Aφ</th> <th>Bφ</th> <th>Cφ</th> <th>Dφ</th> </tr> </thead> <tbody> <tr> <td>RG-142B/U</td> <td>0.991φ</td> <td>2.95φ<sup>±0.12</sup></td> <td>4.34φ</td> <td>4.95φ<sup>±0.12</sup></td> </tr> <tr> <td>RG-55/U</td> <td>0.813φ</td> <td>2.95φ<sup>±0.12</sup></td> <td>4.47φ</td> <td>5.25φ or less</td> </tr> <tr> <th>Cable name</th> <th>Eφ</th> <th>Fφ</th> <th>Gφ</th> <th>Hφ</th> </tr> <tr> <td>RG-58/U</td> <td>19/0.18φ</td> <td>2.95φ<sup>±0.1</sup></td> <td>3.81φ</td> <td>4.95φ<sup>±0.1</sup></td> </tr> </tbody> </table>	Unit: mm					Cable name	Aφ	Bφ	Cφ	Dφ	RG-142B/U	0.991φ	2.95φ <sup>±0.12</sup>	4.34φ	4.95φ <sup>±0.12</sup>	RG-55/U	0.813φ	2.95φ <sup>±0.12</sup>	4.47φ	5.25φ or less	Cable name	Eφ	Fφ	Gφ	Hφ	RG-58/U	19/0.18φ	2.95φ <sup>±0.1</sup>	3.81φ	4.95φ <sup>±0.1</sup>
Cable name	Aφ	Bφ	Cφ																																								
.141-inch semi-rigid cables	0.912φ	2.946φ <sup>±0.025</sup> ~3.01φ <sup>±0.025</sup>	3.581φ <sup>±0.025</sup>																																								
.085-inch semi-rigid cables	0.511φ	1.671φ <sup>±0.0025</sup>	2.197φ <sup>±0.025</sup>																																								
Unit: mm																																											
Cable name	Aφ	Bφ	Cφ	Dφ																																							
RG-142B/U	0.991φ	2.95φ <sup>±0.12</sup>	4.34φ	4.95φ <sup>±0.12</sup>																																							
RG-55/U	0.813φ	2.95φ <sup>±0.12</sup>	4.47φ	5.25φ or less																																							
Cable name	Eφ	Fφ	Gφ	Hφ																																							
RG-58/U	19/0.18φ	2.95φ <sup>±0.1</sup>	3.81φ	4.95φ <sup>±0.1</sup>																																							

# POB SERIES RF CO-AXIAL CONNECTORS

## Connecting tools

Part No.	Overview of tool
POB-T-1	Supporting tool used when soldering L-type plugs
HT303/HRM-T-4	Tool for solderless connection of connectors for flexible cables
HRM-T-5	Tool for bending .141-inch semi-rigid cables
HRM-T-6	Positioning tool used when soldering .141-inch semi-rigid cables
HRM-T-8	Positioning tool used when soldering .085-inch semi-rigid cables
HRM-T-9	Tool for bending .085-inch semi-rigid cables

Applicable connectors	Types of cables	Tools used
POB-P-141, POB-J-141 POB-PJ-141	.141-inch semi-rigid cables	HRM-T-5, T-6
POB-LP-141	.141-inch semi-rigid cables	POB-T-1 HRM-T-5
POB-P-85, POB-J-85 POB-PJ-85	.085-inch semi-rigid cables	HRM-T-8, T-9
POB-LP-85	.085-inch semi-rigid cables	POB-T-1 HRM-T-9
POB-P-55/U, POB-J-55/U POB-PJ-55/U	RG-142B/U, RG-55/U	HT303/HRM-T-4
POB-P-58/U, POB-J-58/U POB-PJ-58/U	RG-58/U	HT303/HRM-T-4
POB-LP-55/U	RG-142B/U, RG-55/U	POB-T-1 HT303/HRM-T-4
POB-LP-58/U	RG-58/U	POB-T-1 HT303/HRM-T-4

\*1 Make crimp connections with the larger hexagonal hole of HT303/HRM-T-4  
 \*2 Make crimp connections with the smaller hexagonal hole of HT303/HRM-T-4

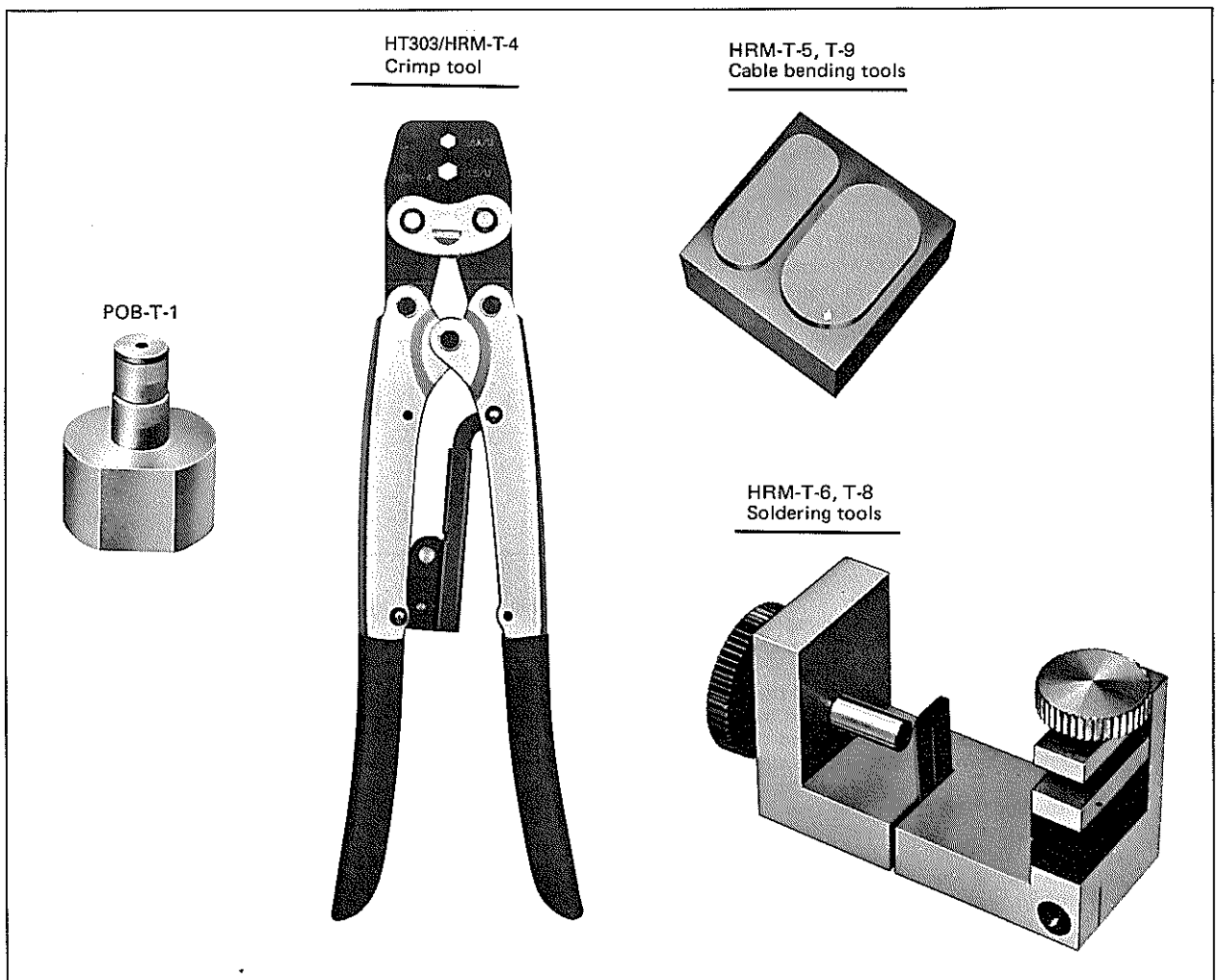

# POB SERIES RF CO-AXIAL CONNECTORS

## Connecting Methods

### 1. POB-P-141, POB-J-141, POB-PJ-141, POB-P-85, POB-J-85, POB-PJ-85

- (1) Cut cable.  
When cutting semi-rigid cables, cut them at the actually needed length  $\ell$  plus 2.3mm.  
Note 1: Take care that the cut surface is vertical.  
Note 2: Length  $\ell$  should be the length of the outer conductor of the cable after the wiring has been completely connected.

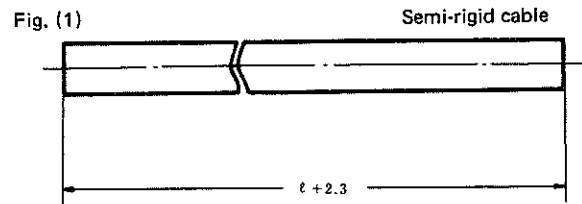

- (2) Fasten the cable to the shell by soldering.  
(Use HRM-T-6 or T-8.)  
i) Fasten ① in Fig. (2) with a vice.  
ii) As shown in the figure, pass the tightening fixture through the cable, and fasten the cable by tightening ③.  
iii) Next, tighten ② so that the cable tip protrudes 2.3mm from the tip of the shell.  
iv) Fasten the tightening fixture by soldering it to the cable.

Note 1: It is desirable to use at this time a soldering iron of about 80W.

Note 2: The solder must be applied evenly on the circumference.

Note 3: During soldering, be careful not to allow the tip of the tightening fixture to move away from ②.

Note 4: Screw ③ must be tightened tightly so that the cable will not move as a result of the thermal stress generated by the soldering.

Note 5: Polish the soldering part of the cable in advance with sandpaper or the like so that the solder will adhere easily to it.

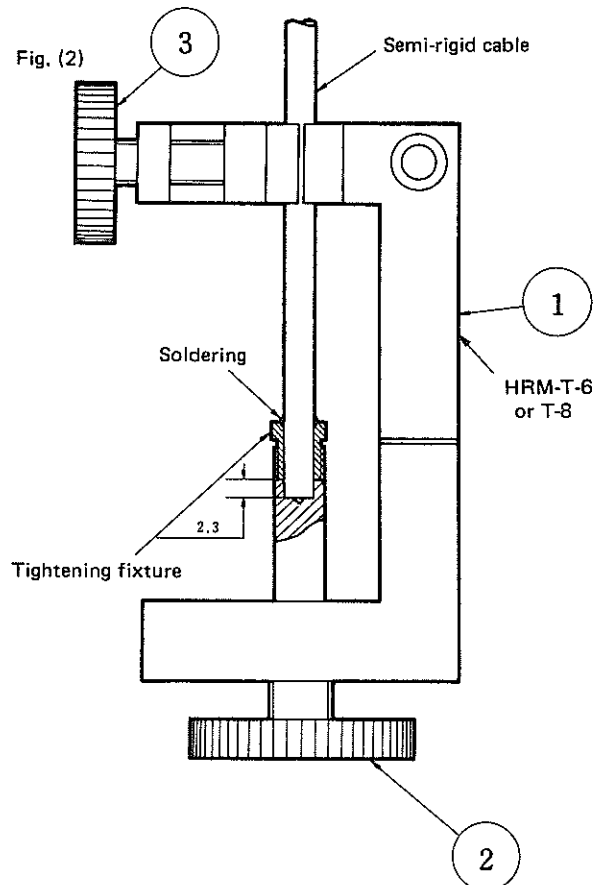

- (3) Cut off the outer conductor of the cable with a fret saw at the tip position of the tightening fixture.  
(Refer to Fig. (3).)

Note 1: Be careful not to damage the tip of the tightening fixture when cutting the cable, and be sure that the tip of the tightening fixture and the cut surface of the cable will be on the same surface.

Note 2: The slit with a width of 0.4 on the tool is provided so that the fret saw will stop between the center conductor and outer conductor of the cable. Care is necessary because if the tool is damaged during cutting the depth of the slit will change, and consequently the center conductor of the cable will be damaged.

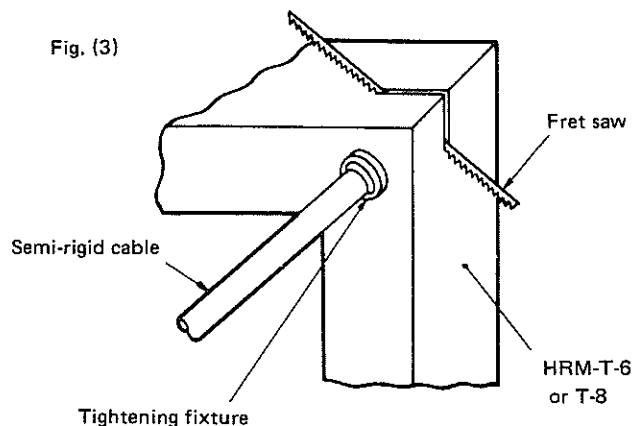

# POB SERIES RF CO-AXIAL CONNECTORS

(4) Cut the cable insulation vertically at the tip of the tightening fixture (using a razor) and remove it. (Refer to Fig. (4) )

Note 1: Finish so that the tips will also be on the same surface.

Note 2: Be careful that the center conductor of the cable is not bent or damaged.

Fig. (4)

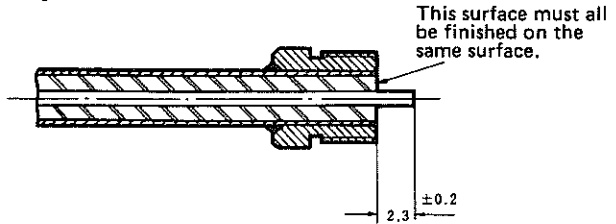

(5) Solder the contact to the center conductor of the cable. (Refer to Fig. (5), Fig. (6))

i) Put the positioning plate of the center conductor ① into the groove of the HRM-T-6 or T-8 proper.

ii) Mount the block in Fig. (4) onto HRM-T-6 or T-8, as shown in Fig. (5). The tip will strike against ①. Pass the center conductor of the cable through the groove of ①, and fasten at that position.

iii) Fit the contact of the connector into the contact holder ③. Perform preliminary soldering and insert as shown in Fig. (5) from the horizontal hole in the HRM-T-6 or T-8 proper ④. Align the center conductor of the cable with the female contact hole while heating the contact with the soldering iron, and press it until it strikes against ①.

iv) After the soldering is finished, remove ① and remove the block from the HRM-T-6 or T-8 proper ④ and the contact holder ③. Finish the place which was soldered with a razor or the like uniformly on the circumference. (Refer to Fig. (6) )

Note 1: It is desirable to use a soldering iron of about 20 ~ 30W.

Note 2: Be careful that extra solder does not flow onto the center conductor of the cable at the part  $0.4 \pm_{-0.04}^0$  in Fig. (6).

Fig. (5)

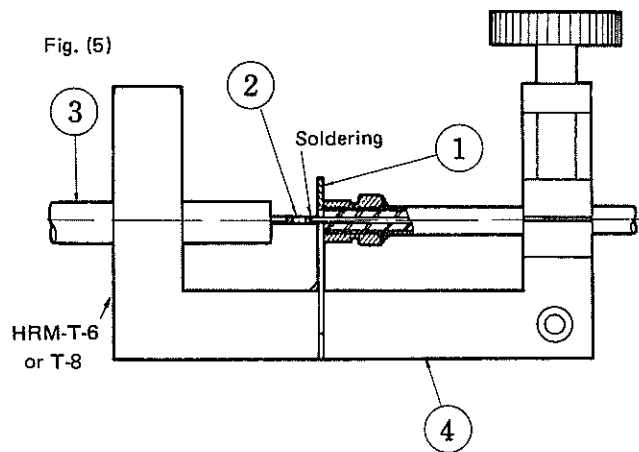
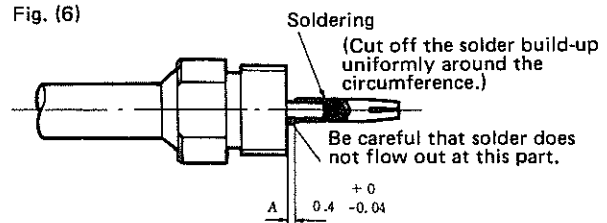

Fig. (6)



(6) Screw the block into the connector proper. Connection of the wiring will be completed as in Fig. (7) when the block in Fig. (6) is screwed into the connector proper.

Note 1: The screw must be tightened with a torque of 30kg-cm or more. When it is especially necessary to prevent the screw from loosening, lock paint is to be applied as is shown in the figure.

Fig. (7)

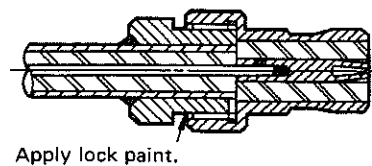



# POB SERIES RF CO-AXIAL CONNECTORS

## 2. POB-LP-141, POB-LP-85

(1) Process cable ends. (Refer to Fig. (8))

Let the center conductor of the cable protrude 2.5 mm and remove the outer conductor and insulation.

Note 1: Finish the outer conductor and insulation vertically and uniformly with a fret saw or the like.

Note 2: When cutting, be careful not to damage the center conductor.

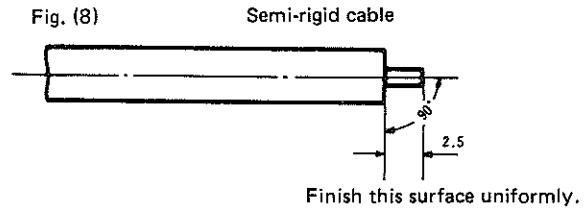

(2) Solder the center conductor of the cable to the male contact of the connector. (Refer to Fig. (9))

i) Fit POB-T-1 and hold it firmly in place with a vice.

ii) Remove the screw cover, insert the cable after processing as shown in Fig. (8) through the cord inlet, and solder it as shown in Fig. (9).

Note 1: Insert the cable until the tip of the outer conductor comes into contact with the inner surface of the connector shell, as shown in Fig. (9). Insert the center conductor into the groove of the male contact of the connector, and solder it.

Note 2: When soldering, be careful not to apply solder to the center conductor of the cable or to the outer surface of the female contact of the connector.

Note 3: It is desirable to use a soldering iron of about 20 ~ 30W. Its tip must be narrowed so as to make the work easy.

Note 4: When soldering, be careful to avoid knobby soldering. (To check this point, rotate the cable after soldering.)

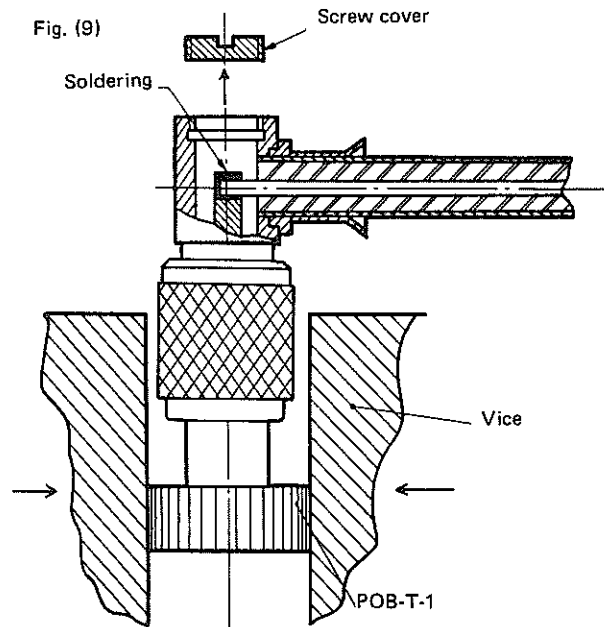

(3) Solder the outer conductor.

Fit POB-T-1 into the opening part as shown in Fig. (10), hold it in a vice, and solder the outer conductor of the cable and the connector shell.

Note 1: It is desirable to use a soldering iron of about 80W.

Note 2: Apply the solder uniformly on the circumference, and carry out the soldering as speedily as possible.

Note 3: Polish the soldered part of the cable in advance with sandpaper or the like so that the solder will adhere easily to it.

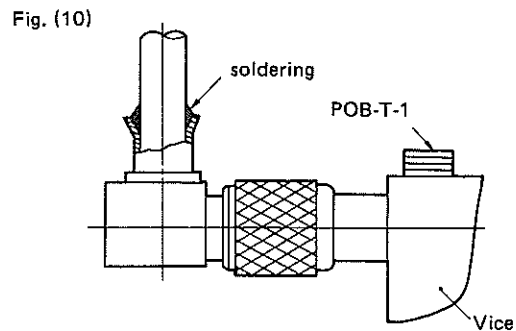

(3) Remove POB-T-1 and screw in the screw cover. Then the connections of the wiring will be completed as shown in Fig. (11).

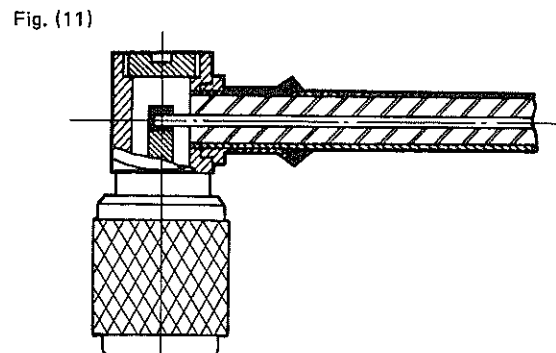

# POB SERIES RF CO-AXIAL CONNECTORS

## 3. POB-P-55/U, POB-P-58/U

(1) Process cable ends (Refer to Fig. (12))

- i) Cut off 10mm of the outer covering of the cable. Next cut off the outer conductor and insulation so that 2.3mm of the center conductor will protrude.

Note 1: When cutting the outer covering and insulation, be careful not to damage the outer conductor and the center conductor.

Note 2: Be sure to cut the cable insulation vertically and flatly.

Fig. (12)

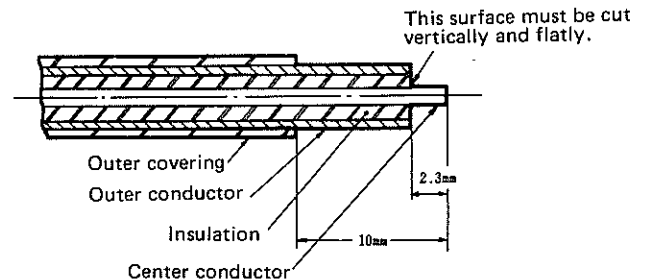

(2) Solder the center conductor

Hold the male contact in place with a vice as shown in Fig. (13) and solder it to the center conductor of the cable.

Note 1: Before soldering, apply preliminary solder on the male contact in advance.

Note 2: It is a good idea to make a hole of  $0.8\phi$ , as shown in Fig. (13), at the part where the male contact is to be held in the vice.

Note 3: Be careful to perform the soldering speedily so that the tip of the cable insulation will not dissolve as a result of the heat during soldering.

Note 4: The build-up of solder after soldering must be finished uniformly on the circumference. To check the strength of the soldering, pull the male contact with a force of about 1kg.

Note 5: Be careful not to allow gaps to be produced between the insulation and the contact after soldering.

Note 6: Be careful not to allow the male contact to be soldered in a bent position towards the center conductor of the cable.

Note 7: It is desirable to use a soldering iron of about 20 ~ 30W.

Fig. (13)

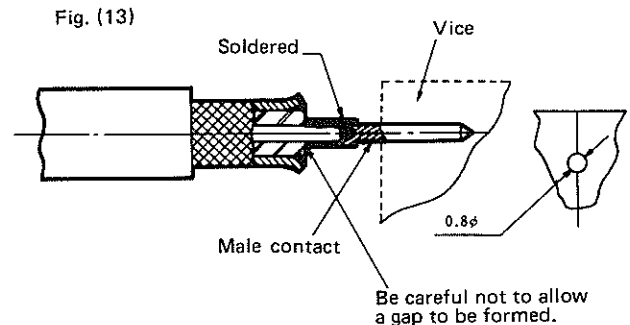

(3) After passing the boot and ferrule (sleeve) over the cable, insert the cable through the connector shell cord inlet, and crimp the ferrule (sleeve) in a hexagonal shape with HT303/HRM-T-4 (Refer to Fig. (14))

- i) To insert the cable, align the male contact with the hole in the insulation, and insert the connector shell between the cable insulation and the outer conductor.

- ii) Insert the ferrule (sleeve) until it strikes against the uneven part of the shell, as shown in Fig. (14), and crimp it in a hexagonal shape with HT303/HRM-T-4

Note 1: Insertion of the cable is finished when the uneven part of the male contact strikes against the connector insulation. Crimping of the ferrule (sleeve) is performed first on the cable side and next on the connector side. (Be careful about the order; if the wrong order is followed, the clamping force will be reduced by one half.)

Fig. (14)

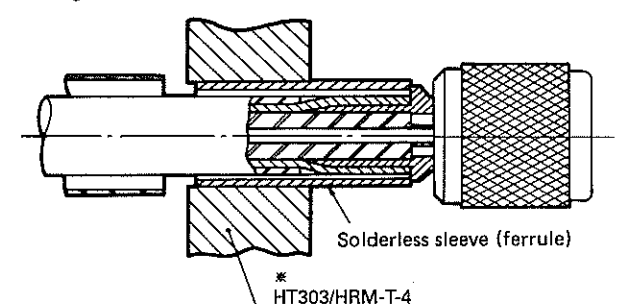

※ POB-P-55/u: Connect with the larger hexagonal hole.  
POB-P-58/u: Connect with the smaller hexagonal hole.

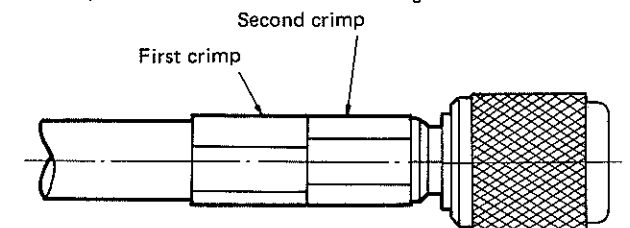

(4) Put on the boot over the solderless sleeve, and apply heat with a hair dryer or the like to cause shrinking. When the connection of the wiring is completed, the appearance will be as shown in Fig. (15).

Note 1: When shrinking, catch the boot on the groove in the shell, as shown in Fig. (15).

Fig. (15)

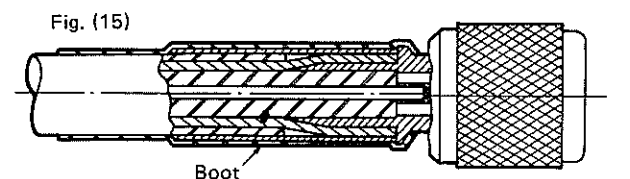

# POB SERIES RF CO-AXIAL CONNECTORS

## 4. POB-J-55/U, POB-PJ-55/U, POB-J-58/U, POB-PJ-58/U

(1) Process the cable ends

- i) Cut off 15.4mm of the outer covering of the cable. Next cut off 7.4mm of the outer conductor, and also cut off 2.3mm of the insulation.

Note 1: When cutting the outer covering and insulation, be careful not to damage the outer conductor and the center conductor.

Note 2: Cut the cable insulation vertically and flatly.

Fig. (16)

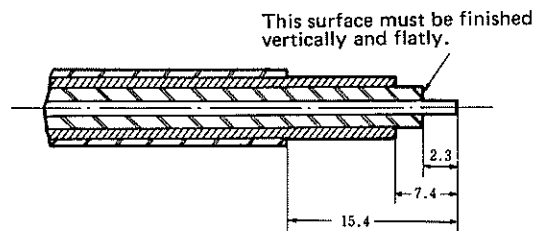

(2) Solder the center conductor.

Using HRM-T-6 or T-8, solder the center conductor by the same procedure as in POB-J-141. (Refer to Fig. (17))

Fig. (17)

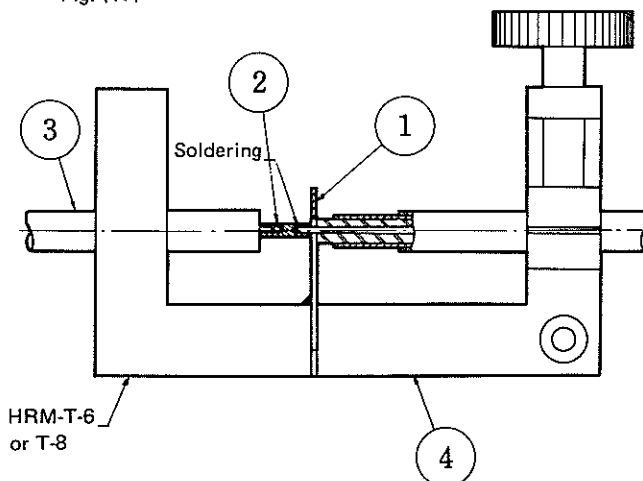

(3) After passing the boot and ferrule (sleeve) over the cable, insert the cable through the connector-shell cord inlet, and crimp the ferrule (sleeve) in a hexagonal shape with HT303/HRM-T-4, (Refer to Fig. (18))

- i) To insert the cable, align the female contact with the hole in the insulation, and insert the connector shell between the insulation of the cable and the outer conductor.

- ii) Insert the ferrule (sleeve) until it strikes against the uneven part of the shell, as shown in Fig. (18), and crimp it in a hexagonal shape with HT303/HRM-T-4

Note 1: Spread out the tip in order to make it easy to insert the outer conductor of the cable.

Note 2: Insertion of the cable is finished when the cable insulation strikes against the connector insulation.

Note 3: Crimping of the ferrule (sleeve) is performed first on the cable side and next on the connector side. (Be careful about the order; if the wrong order is followed, the clamping force will be reduced by one half.)

Fig. (18)

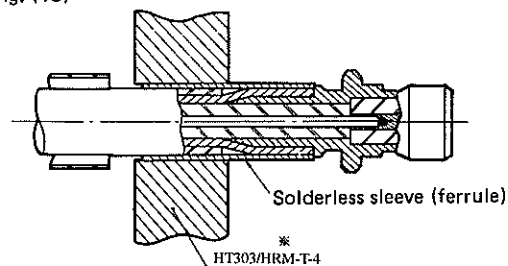

※ POB-P-55/u: Connect with the larger hexagonal hole.  
POB-P-58/u: Connect with the smaller hexagonal hole.

(4) Put on the boot over the ferrule (sleeve), and apply heat with a hair dryer or the like to cause shrinking.

When the connection of the wiring is completed, the appearance will be as shown in Fig. (19).

Note 1: When shrinking, catch the boot on the groove in the shell.

Fig. (19)

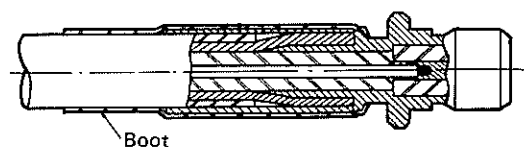

# POB SERIES RF CO-AXIAL CONNECTORS

## 5. POB-LP-55/U, POB-LP-58/U

(1) Process the cable ends

Process the cable ends as shown in Fig. (20).

Note 1: When cutting the outer covering and insulation, be careful not to damage the outer conductor and the center conductor.

Note 2: Cut the insulation vertically and flatly.

Fig. (20)

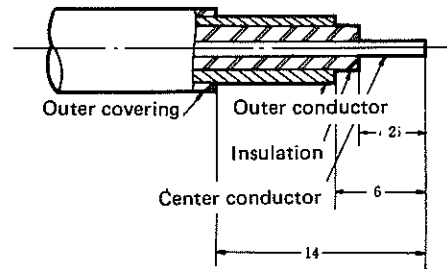

(2) Pass the boot and ferrule (sleeve) over the cable and spread out the tip of the outer conductor. (Refer to Fig. (21))

Fig. (21)

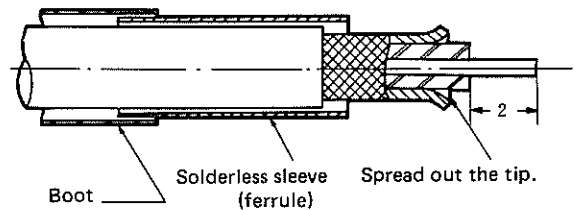

(3) Solder the center conductor and crimp the ferrule (sleeve).

- i) Fit POB-T-1 and hold it firmly in place with a vice.
- ii) Remove the connector screw cover and insert the cable through the cord inlet, as shown in Fig. (22), aligning the center conductor of the cable with the groove at the connector male contact.
- iii) Solder the center conductor of the cable to the male contact at the position where the cable insulation strikes against the male contact.
- iv) After the soldering, check to make sure whether or not it has been carried out perfectly by pulling the cable with a force of about 1 kg of weight. Next insert the ferrule (sleeve) over the outer conductor of the cable until it strikes against the uneven part of the shell, and crimp it in a hexagonal shape with HT303/HRM-T-4

Note 1: Perform the soldering carefully, making sure not to deposit solder on the outer surface of the male end of the connector.

Note 2: It is desirable to use a soldering iron of about 20 ~ 30W. Its tip must be narrowed for easy access.

Note 3: Soils on the inside of the connector produced as a result of soldering should be washed off with thinner or the like in order to prevent the occurrence of faulty insulation or inadequate withstand voltage.

Note 4: Crimping of the ferrule (sleeve) is performed first on the cable side and next on the connector side. (Be careful about the order; if the wrong order is followed, the clamping force will be reduced by one half.)

Fig. (22)

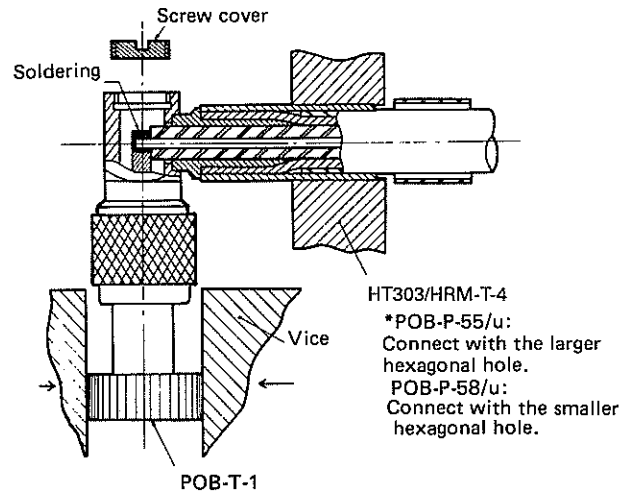

HT303/HRM-T-4  
\*POB-P-55/u:  
Connect with the larger hexagonal hole.  
POB-P-58/u:  
Connect with the smaller hexagonal hole.

(4) Put on the boot over the ferrule (sleeve), and apply heat with a hair dryer or the like to cause shrinking. Then remove POB-T-1 from the opening part and tighten the screw cover.

When the connection of the wiring is completed, the appearance will be as shown in Fig. (23).

Note 1: When shrinking, catch the boot on the groove in the shell, as shown in Fig. (23).

Note 2: Remove POB-T-1 after shrinkage of the boot.

Fig. (23)

