

## SE014S110 Power Module; dc-dc Converter: 48 Vdc Input, 110 Vdc Output, 14 W



The SE014S110 Power Module uses advanced, surface-mount technology and delivers high-quality, compact, dc-dc conversion at an economical price.

### Features

- Small size and low profile:  
50.8 mm x 50.8 mm x 12.7 mm  
(2.00 in. x 2.00 in. x 0.50 in.)
- High efficiency: 82% typical
- Overcurrent protection
- Remote on/off
- Adjustable output voltage
- Output overvoltage protection
- Input-to-output isolation
- Nonconductive case
- *UL*\* 1950 Recognized, *CSA*† C22.2 No. 950-95 Certified
- Meets FCC EMI Class A limits

### Applications

- Communication equipment
- Computer equipment
- Distributed power architectures

### Description

The SE014S110 Power Module is a 14 W, dc-dc converter that operates from a nominal 48 Vdc input and provides a single, isolated, 110 Vdc nominal output. The low-profile module has a maximum height of 12.7 mm (0.50 in). The power module incorporates peak-current control circuitry and a power train that combines high-efficiency power conditioning with a well-regulated output voltage. The output is adjustable over a range from 95 V to 130 V.

\* *UL* is a registered trademark of Underwriters Laboratories, Inc.

† *CSA* is a registered trademark of Canadian Standards Association.

## Absolute Maximum Ratings

Stresses in excess of the absolute maximum ratings can cause permanent damage to the device. These are absolute stress ratings only. Functional operation of the device is not implied at these or any other conditions in excess of those given in the operations sections of the data sheet. Exposure to absolute maximum ratings for extended periods can adversely affect device reliability.

Parameter	Symbol	Min	Max	Unit
Input Voltage	$V_I$	0	63	Vdc
Operating Ambient Temperature ( $0.75 \text{ ms}^{-1}$ (150 ft./min.) above 70 °C)	$T_A$	-40	85	°C
Storage Temperature	$T_{\text{stg}}$	-40	100	°C
I/O Isolation Voltage:				
Continuous	—	—	500	Vdc
Transient (<1 second)	—	—	1000	Vdc

## Electrical Specifications

Unless otherwise indicated, specifications apply over all operating input voltage, resistive load, and temperature conditions.

**Table 1. Input Specifications**

Parameter	Symbol	Min	Typ	Max	Unit
Operating Input Voltage	$V_I$	40	48	60	Vdc
Input Current ( $V_I = 0 \text{ V}$ to 60 V)	$I_{I, \text{max}}$	—	—	0.8	A
Inrush Transient	$i^2t$	—	—	0.2	A <sup>2</sup> s
Input Ripple Voltage (0.5 $\mu\text{H}$ source; see Figure 1.):					
Without External Input Capacitor	—	—	1	—	Vp-p
With External Input Capacitor* ( $C_I = 47 \mu\text{F}$ ; ESR = 0.2 $\Omega$ at $T_A = 25 \text{ }^\circ\text{C}$ )	—	—	100	—	mVp-p

\* In most applications, the external input capacitor is not required to operate the power module. See Design Considerations section.

## Fusing Considerations

**CAUTION: This power module is not internally fused. An input line fuse must always be used.**

This encapsulated power module can be used in a wide variety of applications, ranging from simple stand-alone operation to an integrated part of a sophisticated power architecture. To preserve maximum flexibility, internal fusing is not included; however, to achieve maximum safety and system protection, always use an input line fuse. The safety agencies require a normal-blow fuse with a maximum rating of 5 A in series with the input (see Safety Considerations section). Based on the information provided in this data sheet on inrush energy and maximum dc input current, the same type of fuse with a lower rating can be used. Refer to the fuse manufacturer's data for further information.

**Electrical Specifications** (continued)

**Table 2. Output Specifications**

Parameter	Symbol	Min	Typ	Max	Unit
Output Voltage Set Point ( $V_I = 48\text{ V}$ ; $I_O = I_{O, \text{max}}$ ; $T_A = 25\text{ }^\circ\text{C}$ )	$V_{O, \text{set}}$	107.5	110	112.5	Vdc
Output Voltage (Over all line, resistive load, and temperature conditions until end of life. See Figure 2.)	$V_O$	105	110	115	Vdc
Output Regulation:					
Line ( $V_I = 40\text{ Vdc}$ to $60\text{ Vdc}$ )	—	—	—	0.5	% $V_O$
Load ( $I_O = 0\text{ mA}$ to $130\text{ mA}$ )	—	—	—	0.5	% $V_O$
Temperature ( $T_A = -40\text{ }^\circ\text{C}$ to $+85\text{ }^\circ\text{C}$ )	—	—	—	1.5	% $V_O$
Output Ripple and Noise Voltage (With external output capacitor; $\text{ESR} \leq 1\ \Omega$ at $T_A \geq 0\text{ }^\circ\text{C}$ ):					
RMS	—	—	—	100	mVrms
Peak-to-peak (0 Hz to 20 MHz)	—	—	—	1	Vp-p
Output Current* ( $0.25\text{ ms}^{-1}$ (50 ft./min.) natural convection at $T_A = 70\text{ }^\circ\text{C}$ ; $0.75\text{ ms}^{-1}$ (150 ft./min.) airflow at $T_A = 85\text{ }^\circ\text{C}$ )	$I_O$	5	—	130	mA
Output Current-limit Inception ( $V_O = 100\text{ V}$ )	$I_O$	—	150	—	mA
Output Short-circuit Current ( $V_O = 1\text{ V}$ )	—	—	—	1	A
Efficiency ( $V_I = 48\text{ V}$ ; $I_O = I_{O, \text{max}}$ ; $T_A = 25\text{ }^\circ\text{C}$ ; see Figure 2.)	$\eta$	78	82	—	%
External Output Capacitor:					
Capacitance:					
General Applications	$C_O$	28	—	68	$\mu\text{F}$
Positive Ringing Generator Application†	$C_O$	—	680	—	$\mu\text{F}$
Equivalent Series Resistance at 100 kHz:					
$T_A = 0\text{ }^\circ\text{C}$ to $85\text{ }^\circ\text{C}$	ESR	—	—	1	$\Omega$
$T_A = -40\text{ }^\circ\text{C}$ to $0\text{ }^\circ\text{C}$	ESR	—	—	4	$\Omega$

\* At  $I_O < 5\text{ mA}$ , the output ripple may exceed the specified maximum output ripple.

† See Positive Ringing Generator Application section.

## Electrical Specifications (continued)

Table 3. Isolation Specifications

Parameter	Min	Typ	Max	Unit
Isolation Capacitance	—	0.01	—	$\mu\text{F}$
Isolation Resistance	1	—	—	$\text{M}\Omega$

## General Specifications

Parameter	Min	Typ	Max	Unit
Calculated MTBF ( $T_c = 40\text{ }^\circ\text{C}$ @ 80% load)	7,300,000			hours
Weight	—	46.5 (1.64)	51.0 (1.8)	g (oz.)
Relative Humidity (noncondensing)	5	—	85	%

## Feature Specifications

Unless otherwise indicated, specifications apply over all operating input voltage, resistive load, and temperature conditions. See Feature Descriptions for further information.

Parameter	Symbol	Min	Typ	Max	Unit
Remote On/Off ( $V_I = 40\text{ V}$ to $60\text{ V}$ ; see Figure 3.):					
Switch Open — Unit Off:					
Leakage Current	—	—	—	10	$\mu\text{A}$
Withstand Voltage	—	—	—	60	V
Voltage Level	$V_{\text{on/off}}$	5.2	—	60	V
Current Source	$I_{\text{on/off}}$	—	—	140	$\mu\text{A}$
Switch Closed — Unit On:					
External Resistor to $V_I(+)$	—	400	—	600	$\text{k}\Omega$
Voltage Level	$V_{\text{on/off}}$	—	—	1.2	V
Sink Current	$I_{\text{on/off}}$	—	—	150	$\mu\text{A}$
Output Overvoltage Protection (clamp)	—	—	142	155	V

## Test Configurations

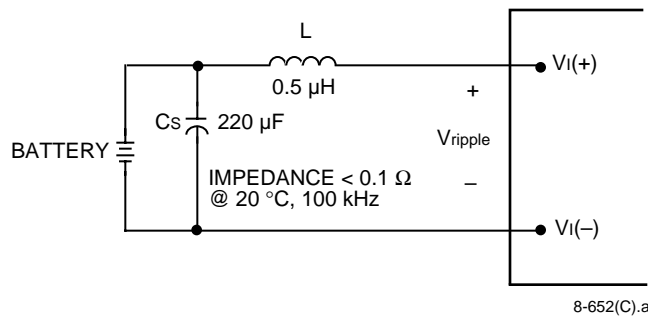

Note: Input reflected-ripple current is measured with a simulated source impedance of 0.5 μH. Capacitor Cs offsets possible battery impedance. Voltage ripple is measured at the input terminals of the module.

Figure 1. Input Reflected-Ripple Test Setup

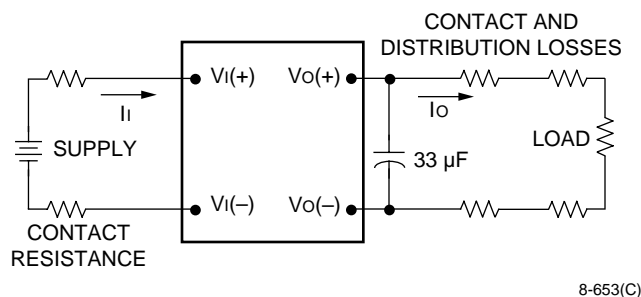

Note: All measurements are taken at the module terminals. When socketing, place Kelvin connections at module terminals to avoid measurement errors due to socket contact resistance.

$$\eta = \left( \frac{[V_{o(+)} - V_{o(-)}] I_o}{[V_{i(+)} - V_{i(-)}] I_i} \right) \times 100 \quad \%$$

Figure 2. Output Voltage and Efficiency Measurement Test Setup

## Design Considerations

### Output Capacitor

An external output capacitor is required for operation of the power module. The output capacitor should be mounted as close as possible to the module output pins. Capacitor and ESR values are shown in the Output Specifications table. The voltage rating of the output capacitor should be at least 160 V.

### Input Capacitor

The power module should be connected to a low ac-impedance input source. Source impedances of greater than 12 μH may affect the stability of the power module. When the source impedance exceeds 12 μH, mount a 47 μF electrolytic capacitor (ESR = 0.2 Ω at 100 kHz, T<sub>A</sub> = 25 °C) as close as possible to the module input pins.

An external input capacitor is not required if the input source impedance is less than 12 μH.

## Safety Considerations

For safety-agency approval of the system in which the power module is used, the power module must be installed in compliance with the spacing and separation requirements of the end-use safety agency standard, i.e., UL 1950 and CSA C22.2 No. 950-95.

If the input source is non-SELV (ELV or a hazardous voltage greater than 60 Vdc and less than or equal to 75 Vdc), for the module's output to be considered meeting the requirements of safety extra-low voltage (SELV), all of the following must be true:

- The input source is to be provided with reinforced insulation from any other hazardous voltages, including the ac mains.
- One Vi pin and one Vo pin are to be grounded or both the input and output pins are to be kept floating.
- The input pins of the module are not operator accessible.
- Another SELV reliability test is conducted on the whole system, as required by the safety agencies, on the combination of supply source and the subject module to verify that under a single fault, hazardous voltages do not appear at the module's output.

**Note:** Do not ground either of the input pins of the module without grounding one of the output pins. This may allow a non-SELV voltage to appear between the output pins and ground.

The power module has extra-low voltage (ELV) outputs when all inputs are ELV.

The input to these units is to be provided with a maximum 5 A normal-blow fuse in the ungrounded lead.

## Feature Descriptions

### Overcurrent Protection

To provide protection in a fault (output overload) condition, the unit is equipped with internal current-limiting circuitry and can endure current limiting for an unlimited duration. At the point of current-limit inception, the unit shifts from voltage control to current control. The unit operates normally once the output current is brought back into its specified range.

### Remote On/Off

Remote on/off enables the user to control the turn-on of the unit, which is especially useful for sequenced circuit powerup. Figure 3 shows the required on/off external circuitry.

If not using remote on/off, to keep the power module on, short the on/off and  $V_I(-)$  terminals together or allow the on/off terminal to float.

The module has internal capacitance to reduce noise at the ON/OFF pin. Additional capacitance is not generally needed and may degrade the start-up characteristics of the module.

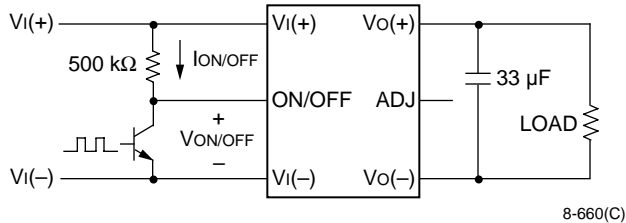

Figure 3. External Remote On/Off Circuitry

### Output Voltage Adjustment

The output voltage can be adjusted by connecting an external resistor from the ADJ pin to  $V_o(+)$  or  $V_o(-)$ . Figures 4 and 6 show the external resistor value required to obtain a certain output voltage. To adjust the output voltage from 95 V to 110 V, place the external resistor between ADJ and  $V_o(+)$  as shown in Figure 5. To adjust the output voltage from 110 V to 130 V, place the external resistor between ADJ and  $V_o(-)$  as shown in Figure 7.

**Note:** At output voltages less than 110 V, the maximum output current is 130 mA. At output voltages greater than 110 V, the maximum output power must be limited to 14 W.

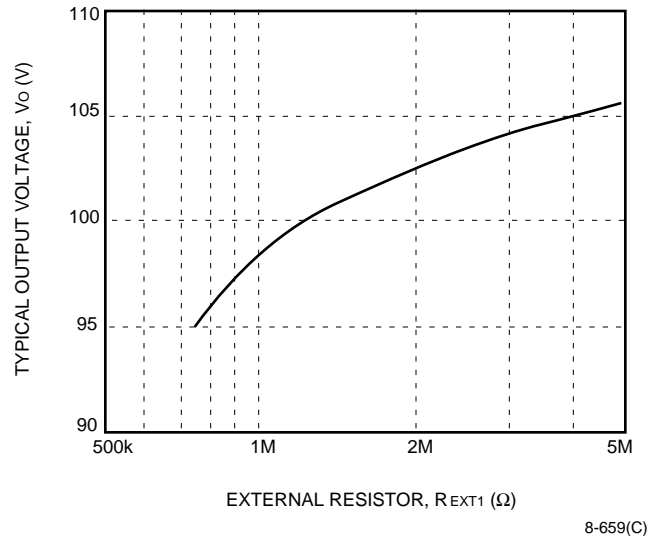

Figure 4. External Resistor Values for Output Voltages from 95 V to 110 V

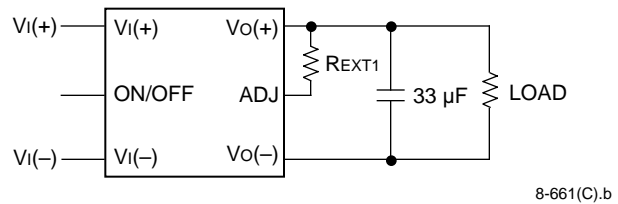
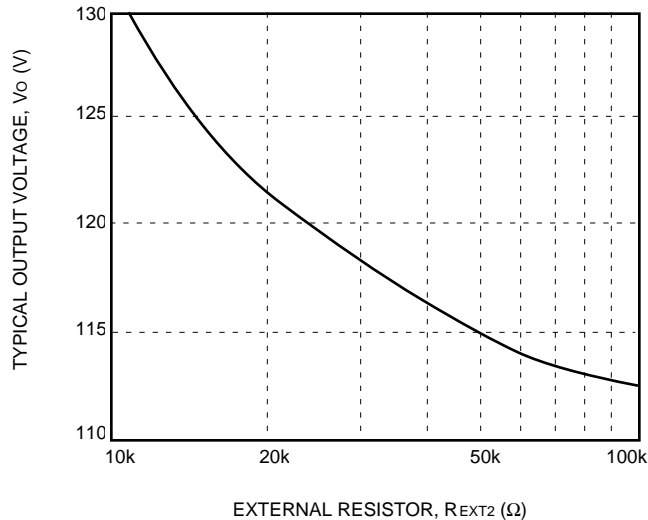

Figure 5. External Circuitry for Output Voltages from 95 V to 110 V

Feature Descriptions (continued)

Output Voltage Adjustment (continued)



8-658(C)

Figure 6. External Resistor Values for Output Voltages from 110 V to 130 V

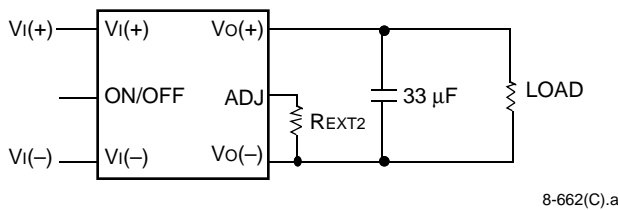

8-662(C).a

Figure 7. External Circuitry for Output Voltages from 110 V to 130 V

Output Overvoltage Protection

The output overvoltage clamp consists of control circuitry, which is independent of the primary regulation loop, that monitors the voltage on the output terminals. The control loop of the clamp has a higher voltage set point than the primary loop (see Feature Specifications table). This provides a redundant voltage control that reduces the risk of output overvoltage.

Positive Ringing Generator Application

The SE014S110 Power Module can be used in a positive ringing generator application. In this application, connect the output of the power module in series with the normal  $-55$  Vdc, 100 Vac, 20 Hz ringing voltage to provide a  $+55$  V ringing voltage. A  $680 \mu\text{F}$  output capacitor is required to provide a low-impedance source at 20 Hz.

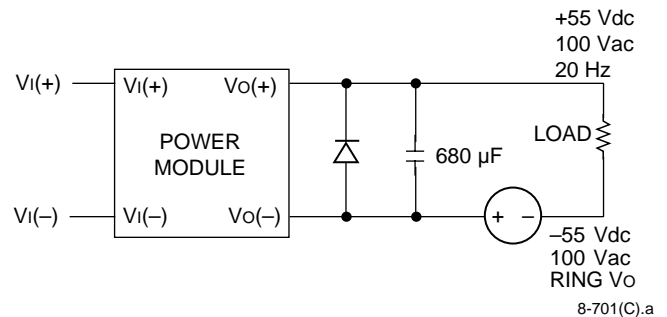

8-701(C).a

Figure 8. Schematic Using the SE014S110 Power Module with Positive Ringing Generation

### Thermal Considerations

Many conditions affect the thermal performance of the power module, such as orientation, airflow over the module, and board spacing. To avoid exceeding the maximum temperature rating of the components inside the power module, the case temperature must be kept below 105 °C. Measure the case temperature at the location shown in Figure 9.

A sample application is shown in Figure 10 with 36 mm (1.4 in.) center-to-center board spacing and a vertical module orientation. Figure 11 shows the temperature derating curves under these conditions.

**Note:** At output voltages less than 110 V, the maximum output current is 130 mA. At output voltages greater than 110 V, the maximum output power is 14 W.

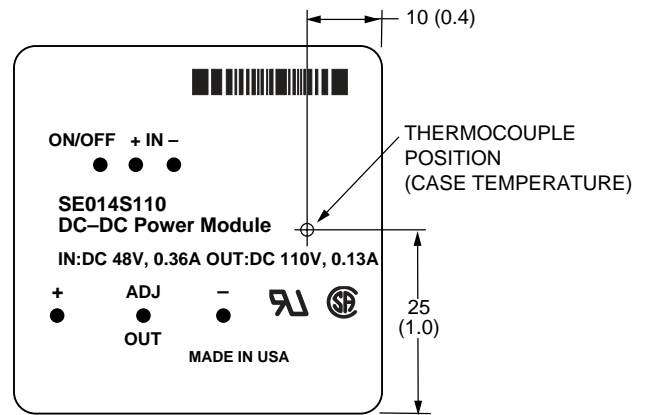

8-657(C)

Note: Top view, pin locations are for reference only. Measurements shown in millimeters and (inches).

**Figure 9. Thermocouple Position for Measuring Case Temperature**

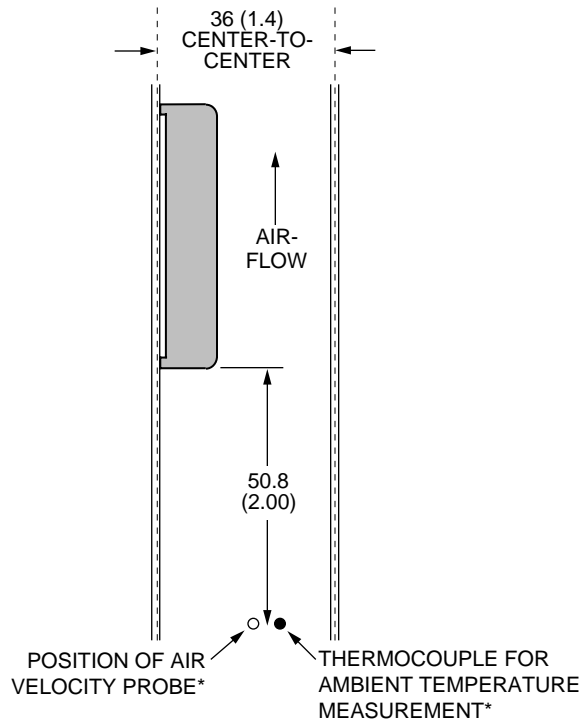

8-656(C)

\* Center the velocity probe and thermocouple in the channel formed between the top of the module and the adjacent PWB.

Note: Measurements shown in millimeters and (inches).

**Figure 10. Power Module Orientation in Test Chamber**

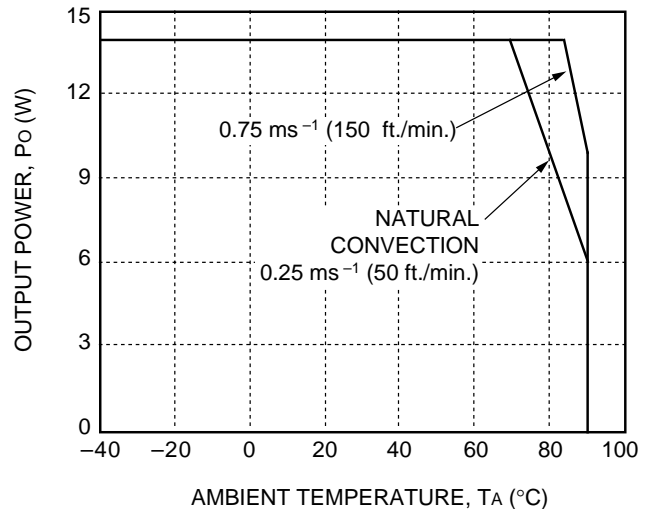

8-655(C)

**Figure 11. Thermal Derating Curves**



## Outline Diagram

Dimensions are in millimeters and (inches).

Module tolerances, unless otherwise indicated:  $x.x \pm 0.5$  mm (0.02 in.),  $x.xx \pm 0.25$  mm (0.010 in.)

### Top View

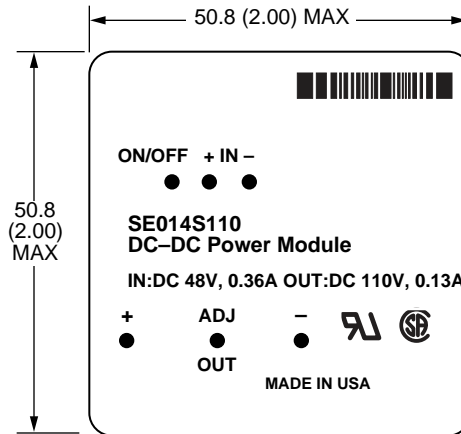

### Side View



### Bottom View

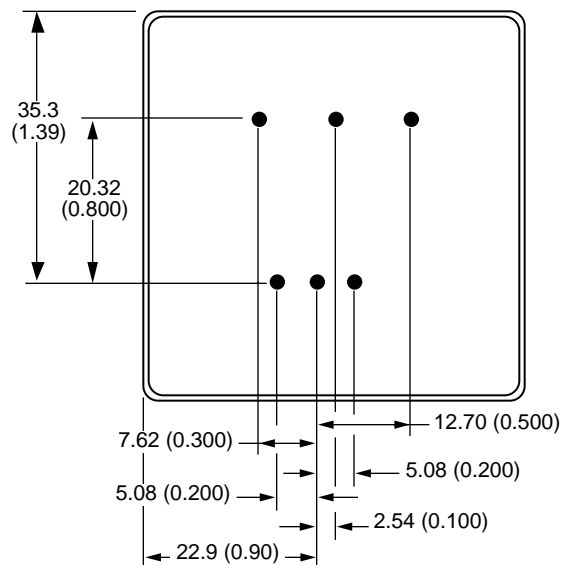

## Recommended Hole Pattern

Component-side footprint.

Dimensions are in millimeters and (inches).

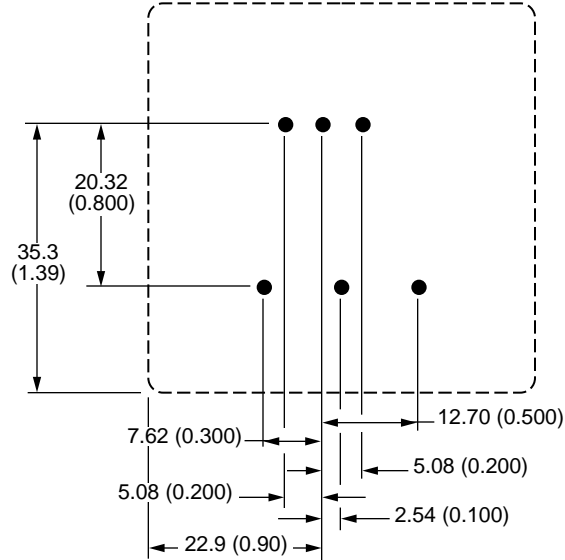

8-654(C).a

## Ordering Information

Please contact your Tyco Electronics' Account Manager or Field Application Engineer for pricing and availability.

Input Voltage	Output Voltage	Output Power	Device Code	Comcode
48 V	110 V	14 W	SE014S110	106573447

## Notes



**Tyco Electronics Power Systems, Inc.**  
3000 Skyline Drive, Mesquite, TX 75149, USA  
**+1-800-526-7819** FAX: +1-888-315-5182  
(Outside U.S.A.: **+1-972-284-2626**, FAX: +1-972-284-2900  
<http://power.tycoelectronics.com>

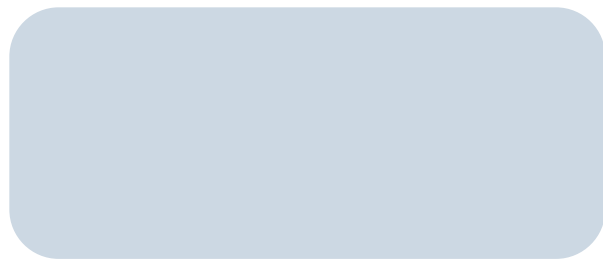

---

Tyco Electronics Corporation reserves the right to make changes to the product(s) or information contained herein without notice. No liability is assumed as a result of their use or application. No rights under any patent accompany the sale of any such product(s) or information.

© 2001 Tyco Electronics Corporation, Harrisburg, PA. All International Rights Reserved.  
Printed in U.S.A.

January 2000  
DS98-225EPS (Replaces DS91-195EPS)

