

Dual and Quad, 8MHz and 60MHz, Low Noise Operational Amplifiers

November 1996

Features

- **Low Noise** $4.3\text{nV}/\sqrt{\text{Hz}}$
- **Bandwidth** **8MHz (Compensated)**
60MHz (Uncompensated)
- **Slew Rate** **$3\text{V}/\mu\text{s}$ (Compensated)**
 $20\text{V}/\mu\text{s}$ (Uncompensated)
- **Low Offset Voltage** **0.5mV**
- **Available in Duals or Quads**

Applications

- Applications
- High Q, Active Filters
- Audio Amplifiers
- Instrumentation Amplifiers
- Integrators
- Signal Generators
- For Further Design Ideas, See Application Note AN554

Description

Low noise and high performance are key words describing HA-5102 and HA-5104, HA-5112, HA-5114. These general purpose amplifiers offer an array of dynamic specifications ranging from a $3\text{V}/\mu\text{s}$ slew rate and 8MHz bandwidth (5102/04) to $20\text{V}/\mu\text{s}$ slew rate and 60MHz gain-bandwidth-product (HA-5112/14). Complementing these outstanding parameters is a very low noise specification of $4.3\text{nV}/\sqrt{\text{Hz}}$ at 1kHz.

Fabricated using the Harris high frequency DI process, these operational amplifiers also offer excellent input specifications such as a 0.5mV offset voltage and 30nA offset current. Complementing these specifications are 108dB open loop gain and 60dB channel separation. Consuming a very modest amount of power (90mW/package for duals and 150mW/package for quads), HA-5102/04/12/14 also provide 15mA of output current.

This impressive combination of features make this series of amplifiers ideally suited for designs ranging from audio amplifiers and active filters to the most demanding signal conditioning and instrumentation circuits.

These operational amplifiers are available in dual or quad form with industry standard pinouts allowing for immediate interchangeability with most other dual and quad operational amplifiers.

HA-5102	Dual, Comp.	HA-5104	Quad, Comp.
HA-5112	Dual, Uncomp.	HA-5114	Quad, Uncomp.

Refer to the /883 data sheet for military product.

 3
**OPERATIONAL
AMPLIFIERS**

Pinouts (See Ordering Information on next page)

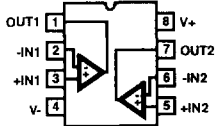
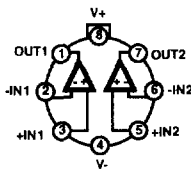
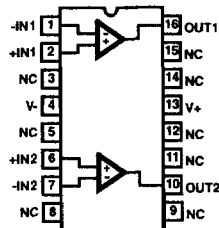
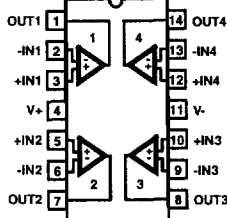
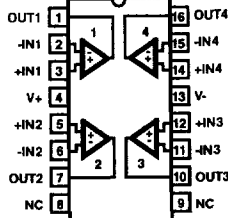
 HA-5102/5112 (PDIP, CERDIP)
TOP VIEW

 HA-5102 (METAL CAN)
TOP VIEW

 HA-5102/5112 (SOIC)
TOP VIEW

 HA-5104/5114 (PDIP, CERDIP)
TOP VIEW

 HA5104/5114 (SOIC)
TOP VIEW

HA-5102, HA-5104, HA-5112, HA-5114**Ordering Information**

PART NUMBER	TEMP. RANGE (°C)	PACKAGE	PKG. NO
HA2-5102-2	-55 to 125	8 Pin Metal Can	T8.C
HA2-5102-5	0 to 75	8 Pin Metal Can	T8.C
HA3-5102-5	0 to 75	8 Ld PDIP	E8.3
HA7-5102-2	-55 to 125	8 Ld CERDIP	F8.3A
HA7-5102-5	0 to 75	8 Ld CERDIP	F8.3A
HA9P5102-5	0 to 75	16 Ld SOIC	M16.3
HA9P5102-9	-40 to 85	16 Ld SOIC	M16.3
HA1-5104-2	-55 to 125	14 Ld CERDIP	F14.3
HA1-5104-5	0 to 75	14 Ld CERDIP	F14.3
HA3-5104-5	0 to 75	14 Ld PDIP	E14.3
HA9P5104-5	0 to 75	16 Ld SOIC	M16.3
HA9P5104-9	-40 to 85	16 Ld SOIC	M16.3
HA3-5112-5	0 to 75	8 Ld PDIP	E8.3
HA7-5112-2	-55 to 125	8 Ld CERDIP	F8.3A
HA9P5112-5	0 to 75	16 Ld SOIC	M16.3
HA9P5112-9	-40 to 85	16 Ld SOIC	M16.3
HA1-5114-2	-55 to 125	14 Ld CERDIP	F14.3
HA1-5114-5	0 to 75	14 Ld CERDIP	F14.3
HA3-5114-5	0 to 75	14 Ld PDIP	E14.3
HA9P5114-5	0 to 75	16 Ld SOIC	M16.3
HA9P5114-9	-40 to 85	16 Ld SOIC	M16.3

HA-5102, HA-5104, HA-5112, HA-5114

Absolute Maximum Ratings

Supply Voltage Between V+ and V- Terminals	40V
Differential Input Voltage	7V
Input Voltage	$\pm V_{SUPPLY}$
Output Short Circuit Duration (Note 3)	Indefinite

Operating Conditions

Temperature Range	
HA-5102/5104/5112/5114-2	-55°C to 125°C
HA-5102/5104/5112/5114-5	0°C to 75°C
HA-5102/5104/5112/5114-9	-40°C to 85°C

Thermal Information

Thermal Resistance (Typical, Note 2)	θ_{JA} (°C/W)	θ_{JC} (°C/W)
Metal Can Package	165	80
8 Lead PDIP Package	92	N/A
8 Lead CERDIP Package	135	50
SOIC Package (HA-5102, HA-5112)	112	N/A
14 Lead CERDIP Package	80	30
14 Lead PDIP Package	86	N/A
SOIC Package (HA-5104, HA-5114)	96	N/A
Maximum Junction Temperature (Note 1, Ceramic Package)	175°C	
Maximum Junction Temperature (Plastic Package)	150°C	
Maximum Storage Temperature Range	-65°C to 150°C	
Maximum Lead Temperature (Soldering 10s)	300°C (SOIC - Lead Tips Only)	

CAUTION: Stresses above those listed in "Absolute Maximum Ratings" may cause permanent damage to the device. This is a stress only rating and operation of the device at these or any other conditions above those indicated in the operational sections of this specification is not implied.

NOTES:

- Maximum power dissipation, including output load, must be designed to maintain the maximum junction temperature below 175°C for hermetic packages, and below 150°C for plastic packages.
- θ_{JA} is measured with the component mounted on an evaluation PC board in free air.
- Any one amplifier may be shorted to ground indefinitely.

Electrical Specifications $V_{SUPPLY} = \pm 15V$, Unless Otherwise Specified

PARAMETER	TEMP. (°C)	HA-5102-2, -5 HA-5112-2, -5			HA-5104-2, -5 HA-5114-2, -5			HA-5102-9 HA-5112-9			HA-5104-9 HA-5114-9			UNITS
		MIN	TYP	MAX	MIN	TYP	MAX	MIN	TYP	MAX	MIN	TYP	MAX	
INPUT CHARACTERISTICS														
Offset Voltage	25	-	0.5	2.0	-	0.5	2.5	-	0.5	2.0	-	0.5	2.5	mV
	Full	-	-	2.5	-	-	3.0	-	-	2.5	-	-	3.0	mV
Offset Voltage Average Drift	Full	-	3	-	-	3	-	-	3	-	-	3	-	$\mu V/^\circ C$
Bias Current	25	-	130	200	-	130	200	-	130	200	-	130	200	nA
	Full	-	-	325	-	-	325	-	-	500	-	-	500	nA
Offset Current	25	-	30	75	-	30	75	-	30	75	-	30	75	nA
	Full	-	-	125	-	-	125	-	-	125	-	-	125	nA
Input Resistance	25	-	500	-	-	500	-	-	500	-	-	500	-	k Ω
Common Mode Range	Full	± 12	-	-	± 12	-	-	± 12	-	-	± 12	-	-	V
TRANSFER CHARACTERISTICS														
Large Signal Voltage Gain ($V_{OUT} = \pm 5V$, $R_L = 2k\Omega$)	25	100	250	-	100	250	-	80	250	-	80	250	-	kV/V
	Full	100	-	-	100	-	-	80	-	-	80	-	-	kV/V
Common Mode Rejection Ratio ($V_{CM} = \pm 5.0V$)	Full	86	95	-	86	95	-	80	95	-	80	95	-	dB
Small Signal Bandwidth														
HA-5102/5104 ($A_V = 1$)	25	-	8	-	-	8	-	-	8	-	-	8	-	MHz
Gain Bandwidth Product														
HA-5112/5114 ($A_V = 10$)	25	-	60	-	-	60	-	-	60	-	-	60	-	MHz
Channel Separation (Note 4)	25	-	60	-	-	60	-	-	60	-	-	60	-	dB

HA-5102, HA-5104, HA-5112, HA-5114

Electrical Specifications $V_{SUPPLY} = \pm 15V$, Unless Otherwise Specified (Continued)

PARAMETER	TEMP. (°C)	HA-5102-2, -5 HA-5112-2, -5			HA-5104-2, -5 HA-5114-2, -5			HA-5102-9 HA-5112-9			HA-5104-9 HA-5114-9			UNITS
		MIN	TYP	MAX	MIN	TYP	MAX	MIN	TYP	MAX	MIN	TYP	MAX	
OUTPUT CHARACTERISTICS														
Output Voltage Swing														
($R_L = 10k\Omega$)	Full	±12	±13	-	±12	±13	-	±12	±13	-	±12	±13	-	V
($R_L = 2k\Omega$)	Full	±10	±12	-	±10	±12	-	±10	±12	-	±10	±12	-	V
Output Current ($V_{OUT} = \pm 5V$)	Full	±10	±15	-	±10	±15	-	±7	±15	-	±7	±15	-	mA
Full Power Bandwidth (Note 5)														
HA-5102/5104	25	16	47	-	16	47	-	16	47	-	16	47	-	kHz
HA-5112/5114	25	191	318	-	191	318	-	191	318	-	191	318	-	kHz
Output Resistance	25	-	110	-	-	110	-	-	110	-	-	110	-	Ω
STABILITY														
Minimum Stable Closed Loop Gain														
HA-5102/5104	Full	1	-	-	1	-	-	1	-	-	1	-	-	V/V
HA-5112/5114	Full	10	-	-	10	-	-	10	-	-	10	-	-	V/V
TRANSIENT RESPONSE (Note 6)														
Rise Time														
HA-5102/5104	25	-	108	200	-	108	200	-	108	200	-	108	200	ns
HA-5112/5114	25	-	48	100	-	48	100	-	48	100	-	48	100	ns
Overshoot														
HA-5102/5104	25	-	20	35	-	20	35	-	20	35	-	20	35	%
HA-5112/5114	25	-	30	40	-	30	40	-	30	40	-	30	40	%
Slew Rate														
HA-5102/5104	25	1	3	-	1	3	-	1	3	-	1	3	-	V/μs
HA-5112/5114	25	12	20	-	12	20	-	12	20	-	12	20	-	V/μs
Settling Time (Note 7)														
HA-5102/5104	25	-	4.5	-	-	4.5	-	-	4.5	-	-	4.5	-	μs
HA-5112/5114	25	-	0.6	-	-	0.6	-	-	0.6	-	-	0.6	-	μs
NOISE CHARACTERISTICS (Note 8)														
Input Noise Voltage														
f = 10Hz	25	-	9	25	-	9	25	-	9	25	-	9	25	nV/√Hz
f = 1kHz	25	-	4.3	6.0	-	4.3	6.0	-	4.3	6.0	-	4.3	6.0	nV/√Hz
Input Noise Current														
f = 10Hz	25	-	5.1	15	-	5.1	15	-	5.1	15	-	5.1	15	pA/√Hz
f = 1kHz	25	-	0.57	3	-	0.57	3	-	0.57	3	-	0.57	3	pA/√Hz
Broadband Noise Voltage														
f = DC to 30kHz	25	-	870	-	-	870	-	-	870	-	-	870	-	nV _{RMS}

HA-5102, HA-5104, HA-5112, HA-5114

Electrical Specifications $V_{SUPPLY} = \pm 15V$, Unless Otherwise Specified (Continued)

PARAMETER	TEMP. (°C)	HA-5102-2, -5 HA-5112-2, -5			HA-5104-2, -5 HA-5114-2, -5			HA-5102-9 HA-5112-9			HA-5104-9 HA-5114-9			UNITS
		MIN	TYP	MAX	MIN	TYP	MAX	MIN	TYP	MAX	MIN	TYP	MAX	
		POWER SUPPLY CHARACTERISTICS												
Supply Current (All Amps)	25	-	3.0	5.0	-	5.0	6.5	-	3.0	5.0	-	5.0	6.5	mA
Power Supply Rejection Ratio ($\Delta V_S = \pm 5V$)	Full	86	100	-	86	100	-	80	100	-	80	100	-	dB

NOTES:

4. Channel separation value is referred to the input of the amplifier. Input test conditions are: $f = 10kHz$; $V_{IN} = 100mV_{PEAK}$; $R_S = 1k\Omega$.
5. Full power bandwidth is guaranteed by equation: Full power bandwidth = $\frac{\text{Slew Rate}}{2\pi V_{PEAK}}$.
6. Refer to Test Circuits section of the data sheet.
7. Settling time is measured to 0.1% of final value for a 1V input step, and $A_V = -10$ for HA-5112/5114, and a 10V input step, $A_V = -1$ for HA-5102/5104.
8. The limits for these parameters are guaranteed based on lab characterization, and reflect lot-to-lot variation.

Test Circuits and Waveforms

HA-5102, HA-5104

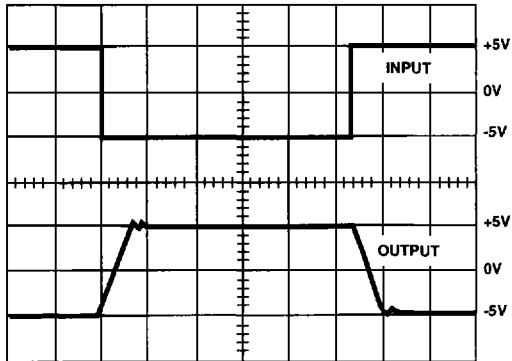
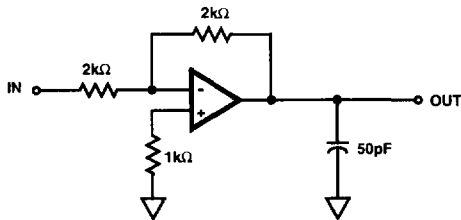

Vertical = 5V/Div., Horizontal = 5μs/Div. ($A_V = -1$)

FIGURE 1. LARGE SIGNAL RESPONSE CIRCUIT

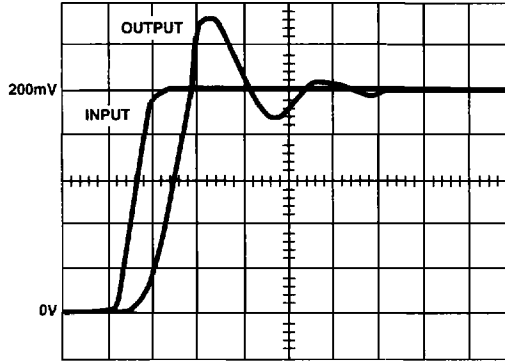
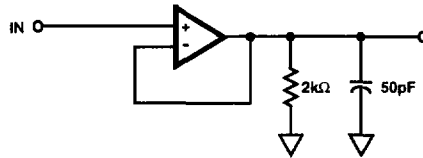

Vertical = 40mV/Div., Horizontal = 50ns/Div. ($A_V = +1$)

FIGURE 2. SMALL SIGNAL RESPONSE CIRCUIT

Test Circuits and Waveforms (Continued)

HA-5112, HA-5114

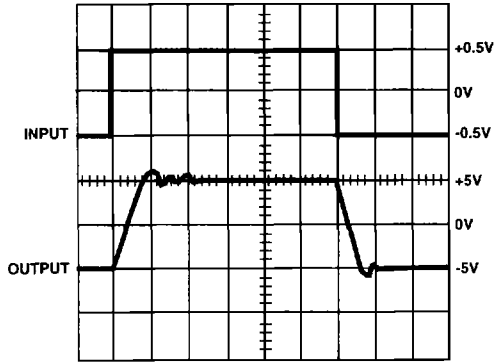

Input = 0.5V/Div., Output = 5V/Div., Time = 50ns/Div.

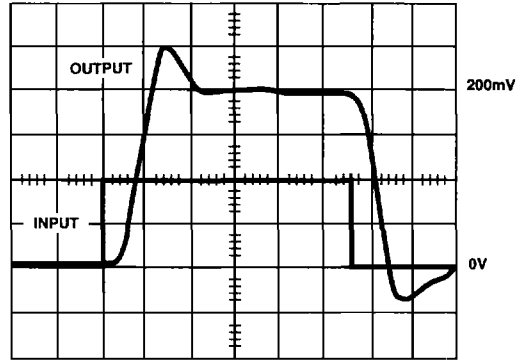

Input = 10mV/Div., Output = 50mV/Div., Time = 50ns/Div.

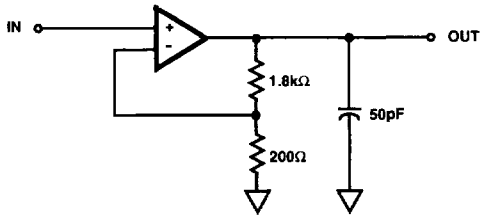

NOTE: $A_V = +10$.

FIGURE 3. LARGE AND SMALL SIGNAL RESPONSE CIRCUIT ($A_V = +10$)

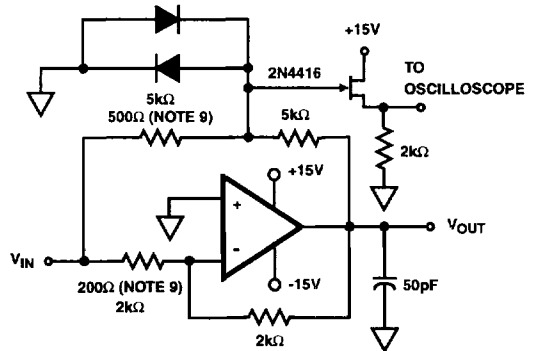

NOTES:

9. $A_V = -1$ (HA-5102/5104), $A_V = -10$ (HA-5112/5114).
10. Feedback and summing resistors should be 0.1% matched.
11. Clipping diodes are optional, HP5082-2810 recommended.

FIGURE 4. SETTLING TIME CIRCUIT

Simplified Schematic

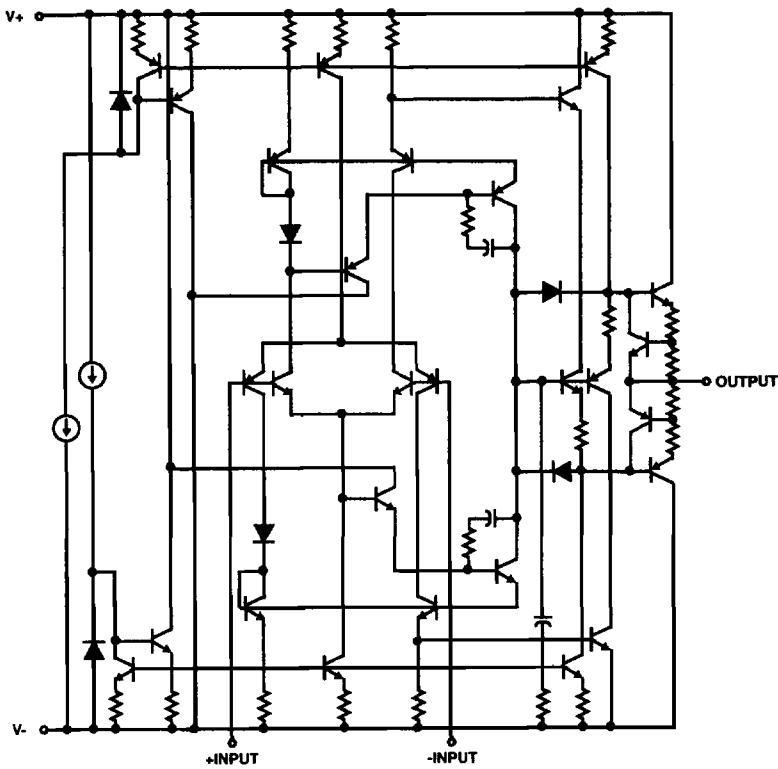

Typical Performance Curves

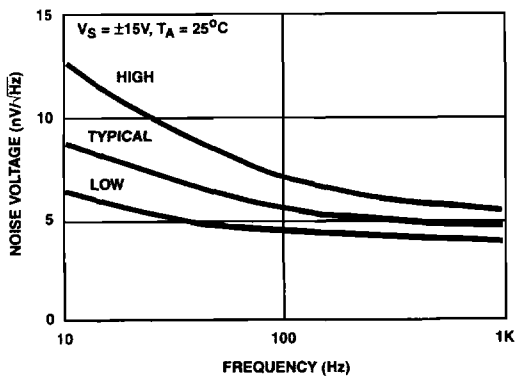

FIGURE 5. INPUT NOISE VOLTAGE DENSITY

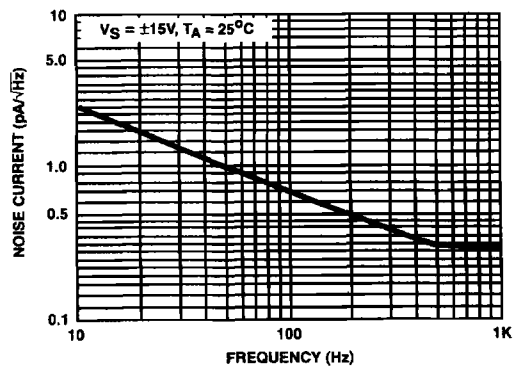
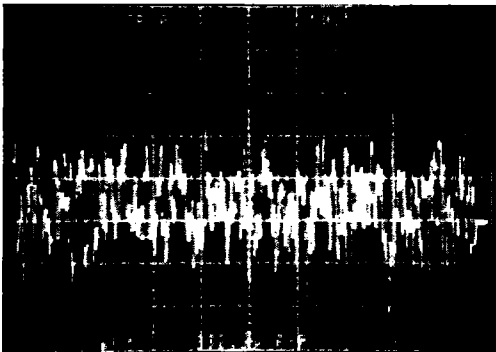

FIGURE 6. INPUT NOISE CURRENT DENSITY

Typical Performance Curves (Continued)



$V_S = \pm 15V$, $T_A = 25^\circ C$, $50\mu V/Div.$, $1s/Div.$, $A_V = 1000V/V$
Input Noise = $0.232\mu V_{p.p}$

FIGURE 7. 0.1Hz TO 10Hz NOISE

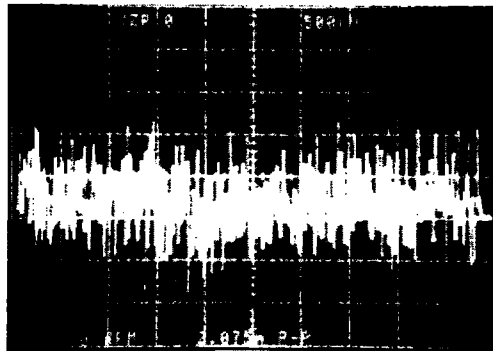

$V_S = \pm 15V$, $T_A = 25^\circ C$, $500\mu V/Div.$, $1s/Div.$, $A_V = 1000V/V$
Total Output Noise = $2.075\mu V_{p.p}$

FIGURE 8. 0.1Hz TO 1MHz NOISE

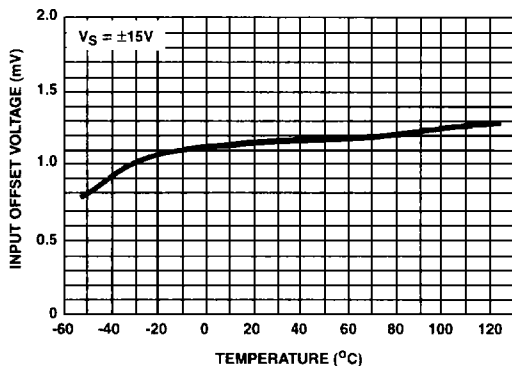

FIGURE 9. V_{IO} vs TEMPERATURE

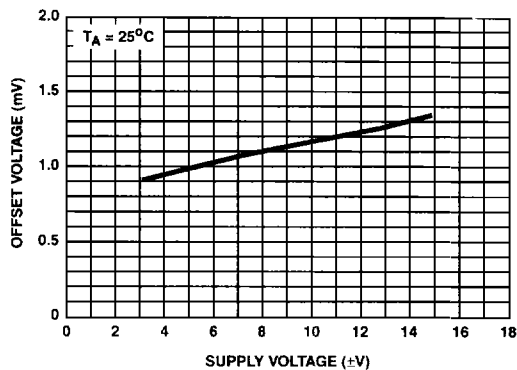

FIGURE 10. V_{IO} vs V_S

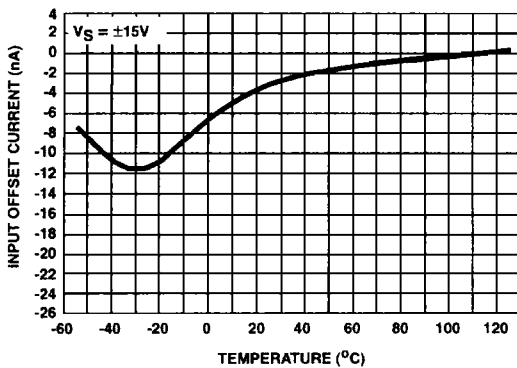

FIGURE 11. I_{IO} vs TEMPERATURE

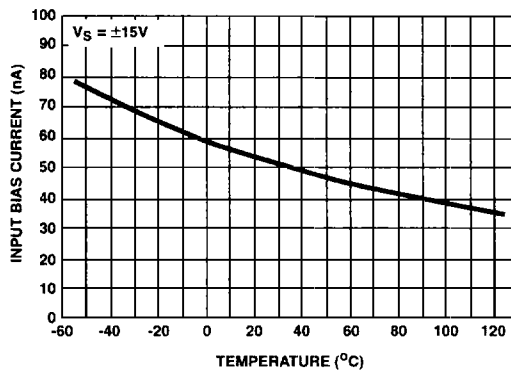

FIGURE 12. I_{BIAS} vs TEMPERATURE

Typical Performance Curves (Continued)

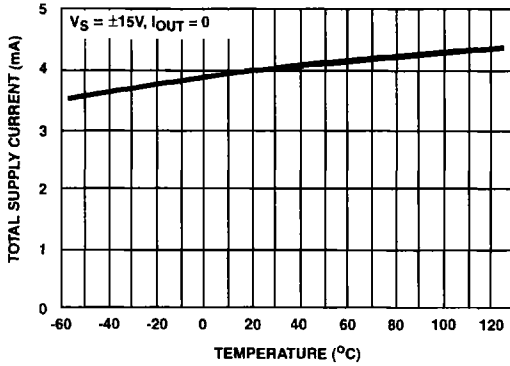

FIGURE 13. I_{CC} vs TEMPERATURE (HA-5104/14)

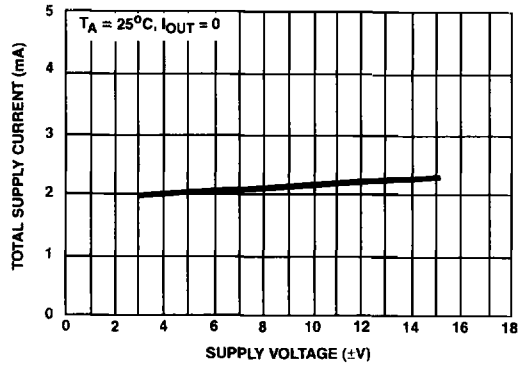

FIGURE 14. I_{CC} vs V_S (HA-5102/12)

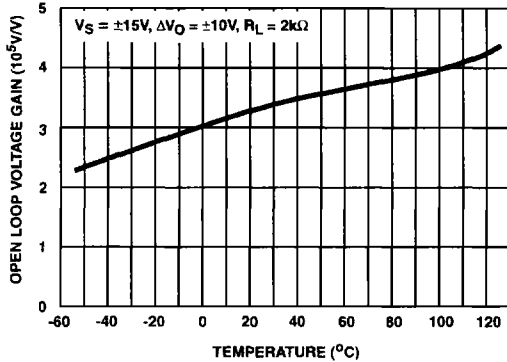

FIGURE 15. A_{VOL} vs TEMPERATURE

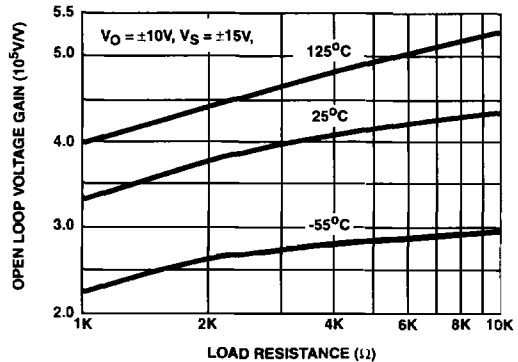

FIGURE 16. A_{VOL} vs LOAD RESISTANCE

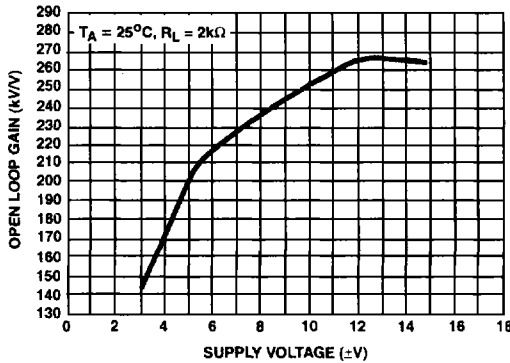

FIGURE 17. A_{VOL} vs V_S

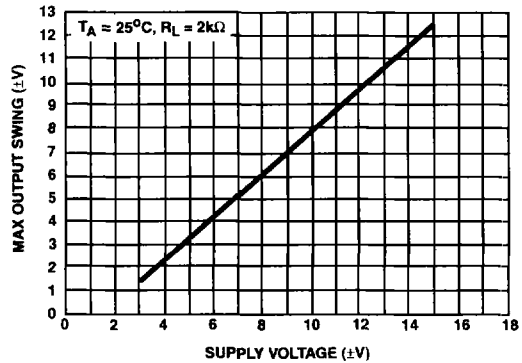

FIGURE 18. V_{OUT} vs V_S

Typical Performance Curves (Continued)

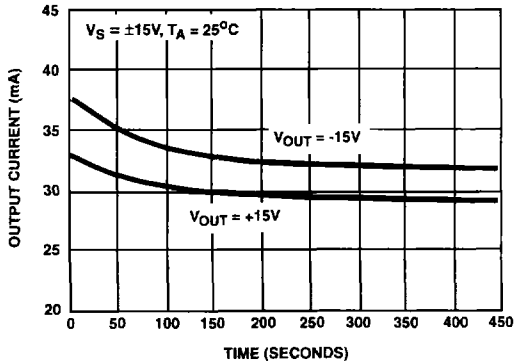

FIGURE 19. OUTPUT SHORT CIRCUIT CURRENT vs TIME

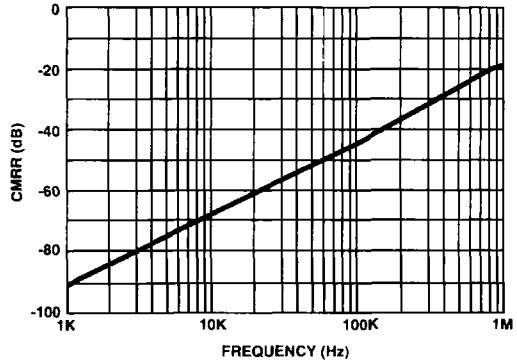

FIGURE 20. CMRR vs FREQUENCY

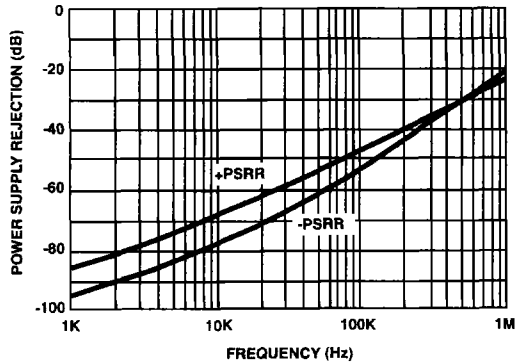

FIGURE 21. PSRR vs FREQUENCY

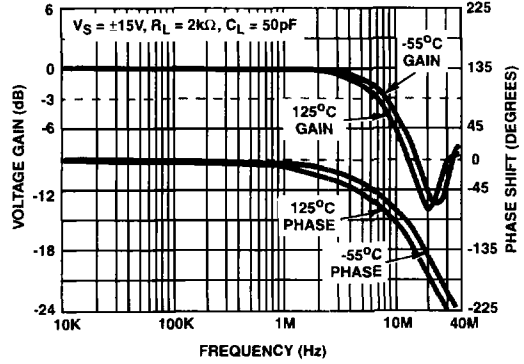

FIGURE 22. HA-5104/02 UNITY GAIN FREQUENCY RESPONSE

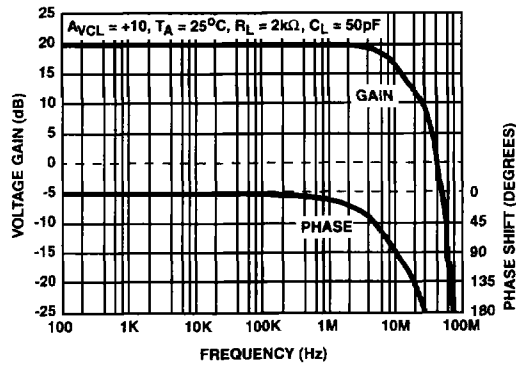

FIGURE 23. HA-5112/14 FREQUENCY RESPONSE

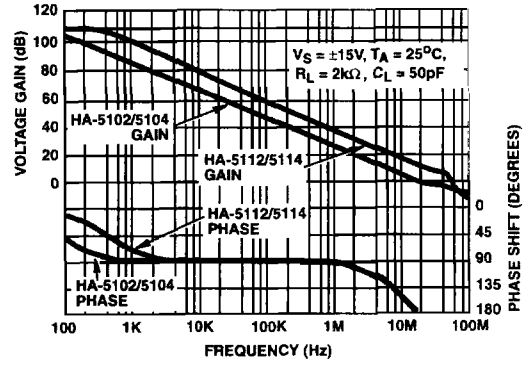

FIGURE 24. OPEN LOOP GAIN vs FREQUENCY

Typical Performance Curves (Continued)

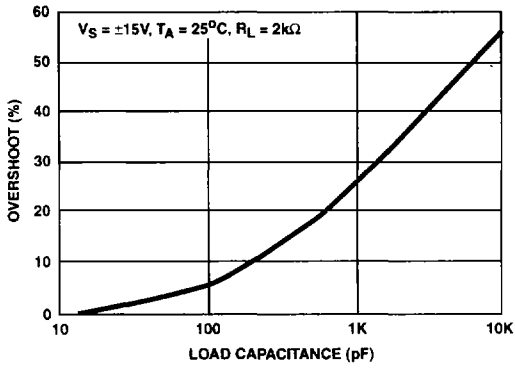

FIGURE 25. SMALL SIGNAL OVERSHOOT vs C_LOAD

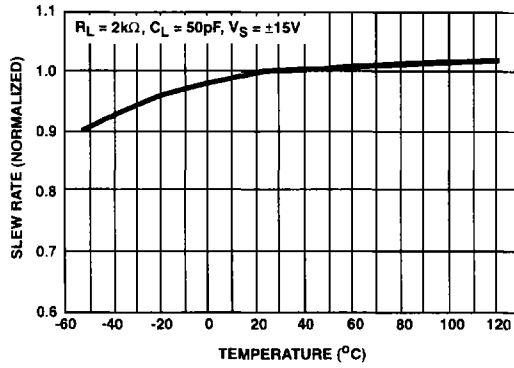

FIGURE 26. SLEW RATE vs TEMPERATURE

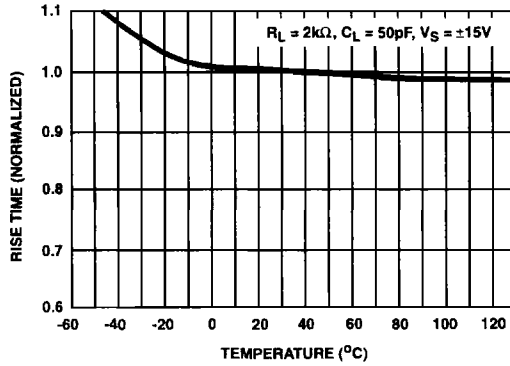

FIGURE 27. RISE TIME vs TEMPERATURE

HA-5102, HA-5104, HA-5112, HA-5114

Die Characteristics

DIE DIMENSIONS:

98.4 mils x 67.3 mils x 19 mils
2500 μ m x 1710 μ m x 483 μ m

METALLIZATION:

Type: Al, 1% Cu
Thickness: 16k Å \pm 2k Å

PASSIVATION:

Type: Nitride (Si₃N₄) over Silox (SiO₂, 5% Phos.)
Silox Thickness: 12k Å \pm 2k Å
Nitride Thickness: 3.5k Å \pm 1.5k Å

SUBSTRATE POTENTIAL (Powered Up):

Unbiased

TRANSISTOR COUNT:

93

PROCESS:

Bipolar Dielectric Isolation

Metallization Mask Layout

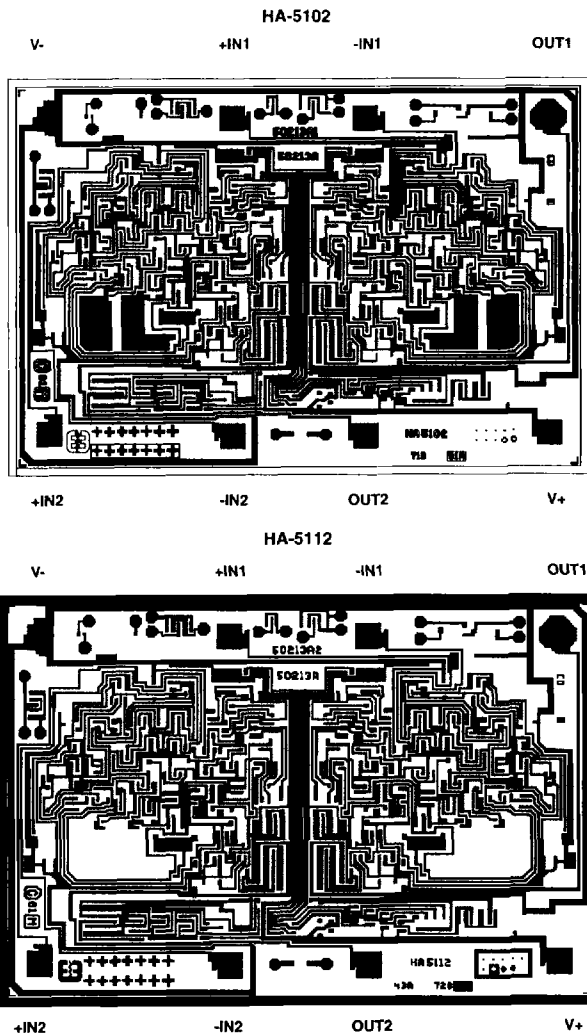

HA-5102, HA-5104, HA-5112, HA-5114

Die Characteristics

DIE DIMENSIONS:

95 mils x 99 mils x 19 mils
 2420 μ m x 2530 μ m x 483 μ m

METALLIZATION:

Type: Al, 1% Cu
 Thickness: 16k \AA \pm 2k \AA

PASSIVATION:

Type: Nitride (Si_3N_4) over Silox (SiO_2 , 5% Phos.)
 Silox Thickness: 12k \AA \pm 2k \AA
 Nitride Thickness: 3.5k \AA \pm 1.5k \AA

SUBSTRATE POTENTIAL (Powered Up):

Unbiased

TRANSISTOR COUNT:

175

PROCESS:

Bipolar Dielectric Isolation

Metallization Mask Layout

