

Main Product Characteristics

BV_{DSS}	-30V
$R_{DS(ON)}$	10m Ω
I_D	-45A

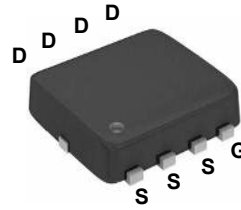

PPAK 3x3

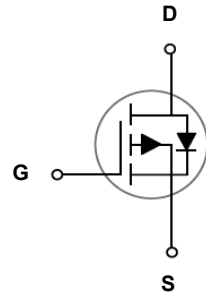

Schematic Diagram

Features and Benefits

- Advanced MOSFET process technology
- Ideal for high efficiency switched mode power supplies
- Low on-resistance with low gate charge
- Fast switching and reverse body recovery



Description

The GSFN0345 utilizes the latest techniques to achieve high cell density and low on-resistance. These features make this device extremely efficient and reliable for use in high efficiency switch mode power supply and a wide variety of other applications.

Absolute Maximum Ratings (T_C=25°C unless otherwise specified)

Parameter	Symbol	Max.	Unit
Drain-Source Voltage	V_{DS}	-30	V
Gate-Source Voltage	V_{GS}	± 20	V
Drain Current-Continuous (T _C =25°C)	I_D	-45	A
Drain Current-Continuous (T _C =100°C)		-28.5	
Drain Current-Pulsed ¹	I_{DM}	-180	A
Single Pulse Avalanche Energy ²	E_{AS}	125	mJ
Single Pulse Avalanche Current ²	I_{AS}	50	A
Power Dissipation (T _C =25°C)	P_D	46	W
Power Dissipation-Derate above 25°C		0.37	
Thermal Resistance, Junction-to-Ambient	$R_{\theta JA}$	62	°C/W
Thermal Resistance, Junction-to-Case	$R_{\theta JC}$	2.7	°C/W
Operating Junction Temperature Range	T_J	-55 To +150	°C
Storage Temperature Range	T_{STG}	-55 To +150	°C

Electrical Characteristics ($T_J=25^{\circ}\text{C}$ unless otherwise specified)

Parameter	Symbol	Conditions	Min.	Typ.	Max.	Unit
On/Off Characteristics						
Drain-Source Breakdown Voltage	BV_{DSS}	$V_{GS}=0V, I_D=-250\mu A$	-30	-	-	V
Drain-Source Leakage Current	I_{DSS}	$V_{DS}=-30V, V_{GS}=0V, T_J=25^{\circ}\text{C}$	-	-	-1	μA
		$V_{DS}=-24V, V_{GS}=0V, T_J=125^{\circ}\text{C}$	-	-	-10	μA
Gate-Source Leakage Current	I_{GSS}	$V_{GS}=\pm 20V, V_{DS}=0V$	-	-	± 100	nA
Static Drain-Source On-Resistance	$R_{DS(ON)}$	$V_{GS}=-10V, I_D=-15A$	-	8.4	10	m Ω
		$V_{GS}=-4.5V, I_D=-10A$	-	13.6	17.7	m Ω
Gate Threshold Voltage	$V_{GS(th)}$	$V_{GS}=V_{DS}, I_D=-250\mu A$	-1.2	-1.6	-2.5	V
Forward Transconductance	g_{fs}	$V_{DS}=-10V, I_D=-3A$	-	7	-	S
Dynamic and Switching Characteristics						
Total Gate Charge ^{3,4}	Q_g	$V_{DS}=-15V, I_D=-20A, V_{GS}=-10V$	-	34	50	nC
Gate-Source Charge ^{3,4}	Q_{gs}		-	5.2	7.8	
Gate-Drain Charge ^{3,4}	Q_{gd}		-	7.9	12	
Turn-On Delay Time ^{3,4}	$t_{d(on)}$	$V_{DD}=-15V, R_G=6\Omega, V_{GS}=-10V, I_D=-1A$	-	20	30	nS
Rise Time ^{3,4}	t_r		-	15	22	
Turn-Off Delay Time ^{3,4}	$t_{d(off)}$		-	40	60	
Fall Time ^{3,4}	t_f		-	30	45	
Input Capacitance	C_{iss}	$V_{DS}=-15V, V_{GS}=0V, F=1\text{MHz}$	-	2020	3000	pF
Output Capacitance	C_{oss}		-	305	460	
Reverse Transfer Capacitance	C_{rss}		-	245	370	
Drain-Source Diode Characteristics and Maximum Ratings						
Continuous Source Current	I_S	$V_G=V_D=0V, \text{Force Current}$	-	-	-45	A
Pulsed Source Current	I_{SM}		-	-	-90	A
Diode Forward Voltage	V_{SD}	$V_{GS}=0V, I_S=-1A, T_J=25^{\circ}\text{C}$	-	-	-1	V
Reverse Recovery Time	t_{rr}	$V_R=-30V, I_R=-10A, di/dt=100A/\mu s, T_J=25^{\circ}\text{C}$	-	80	-	nS
Reverse Recovery Charge	Q_{rr}		-	170	-	nC

Note:

1. Repetitive rating: Pulsed width limited by maximum junction temperature.
2. $V_{DD}=25V, V_{GS}=10V, L=0.1\text{mH}, I_{AS}=50A, R_G=25\Omega, \text{starting } T_J=25^{\circ}\text{C}$.
3. Pulse test: pulse width $\leq 300\mu s, \text{duty cycle} \leq 2\%$.
4. Essentially independent of operation temperature.

Typical Electrical and Thermal Characteristic Curves

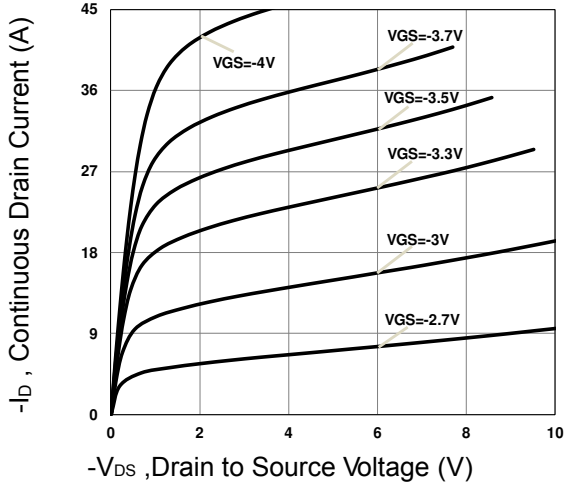

Fig.1 Typical Output Characteristics

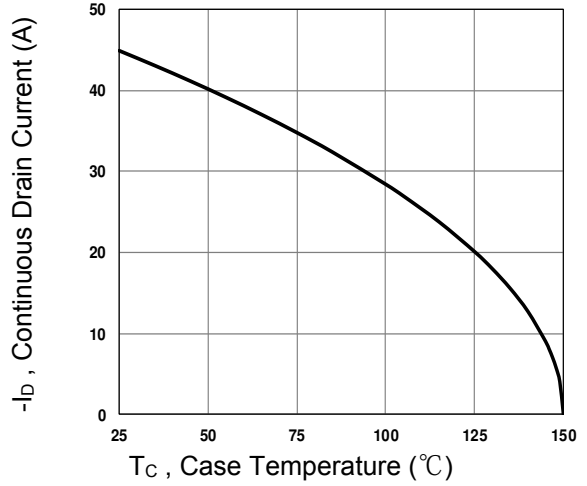

Fig.2 Continuous Drain Current vs. T_C

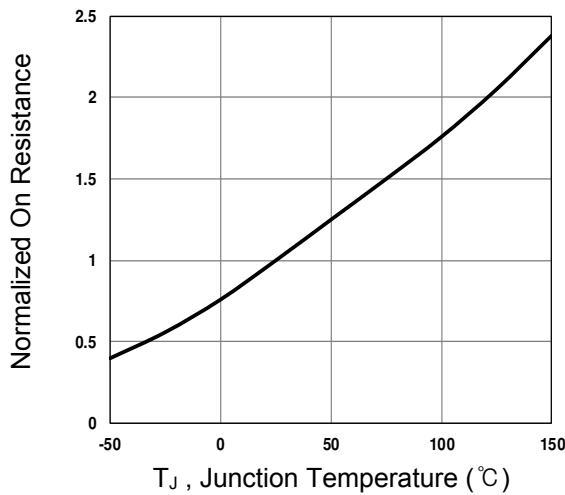

Fig.3 Normalized $R_{DS(ON)}$ vs. T_J

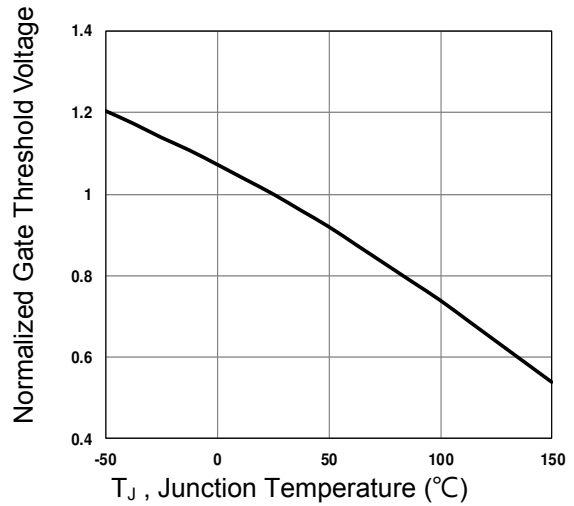

Fig.4 Normalized V_{TH} vs. T_J

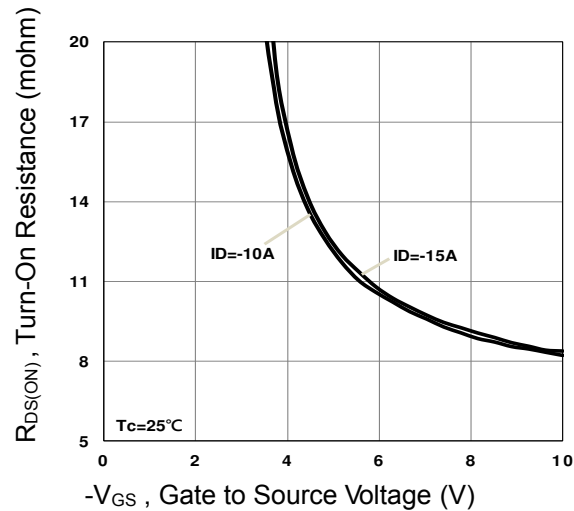

Fig.5 Turn-On Resistance vs. V_{GS}

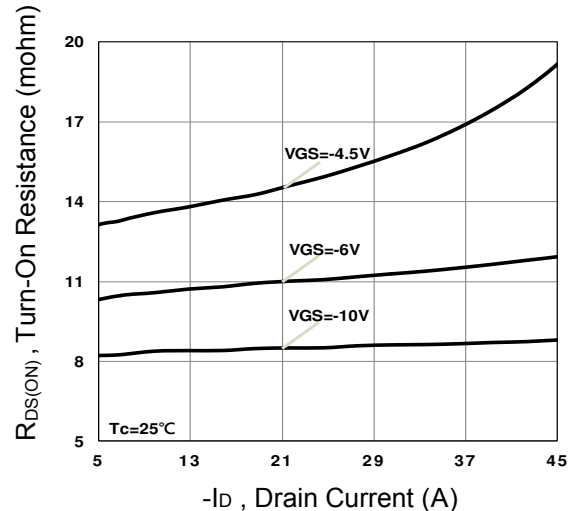

Fig.6 Turn-On Resistance vs. I_D

Typical Electrical and Thermal Characteristic Curves

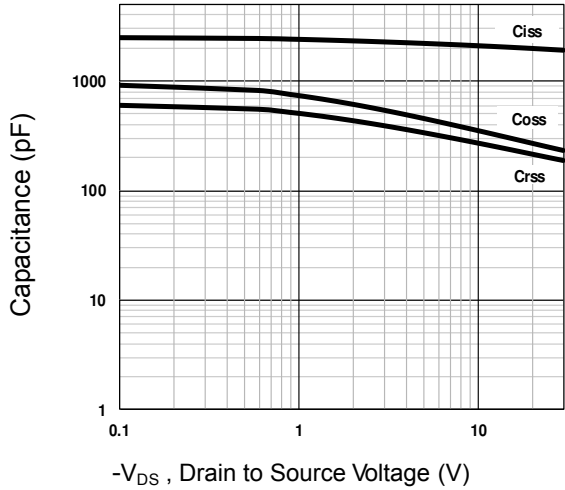

Fig.7 Capacitance Characteristics

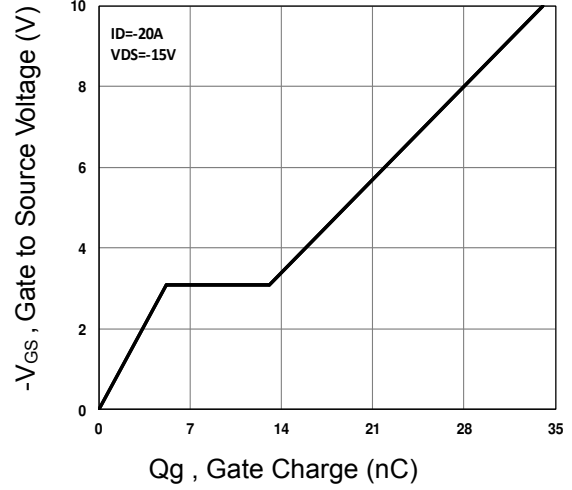

Fig.8 Gate Charge Characteristics

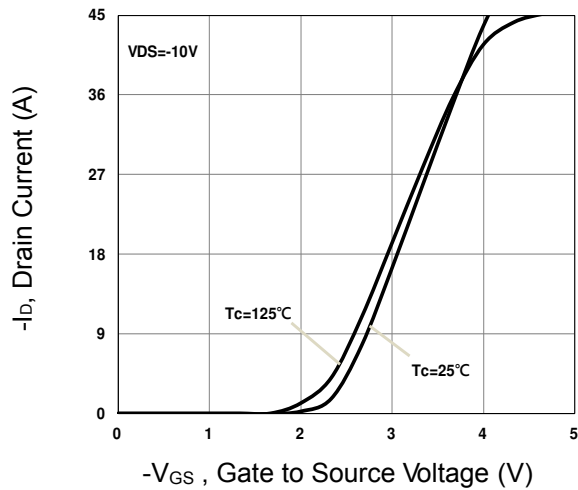

Fig.9 Transfer Characteristics

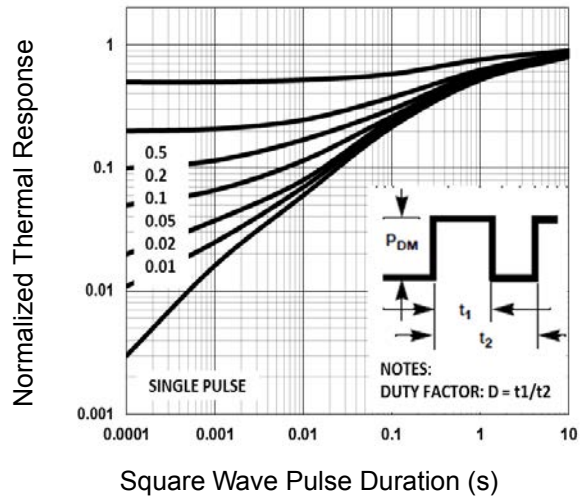

Fig.10 Normalized Transient Impedance

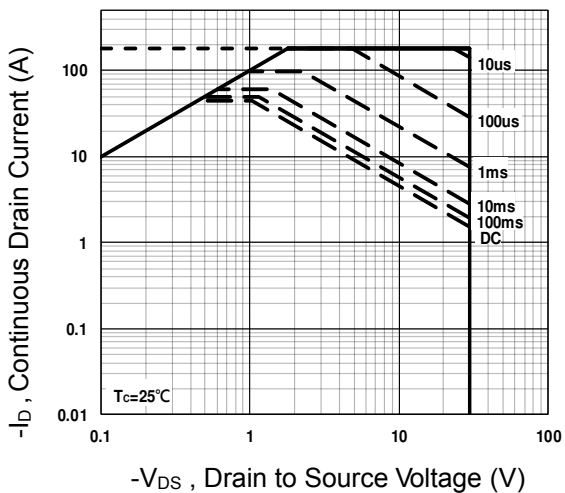

Fig.11 Maximum Safe Operation Area

Typical Electrical and Thermal Characteristic Curves

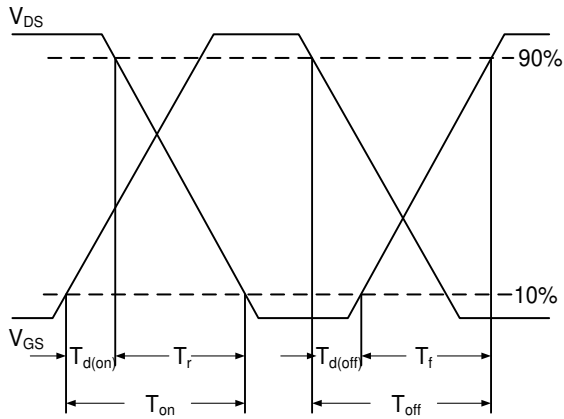

Fig.12 Switching Time Waveform

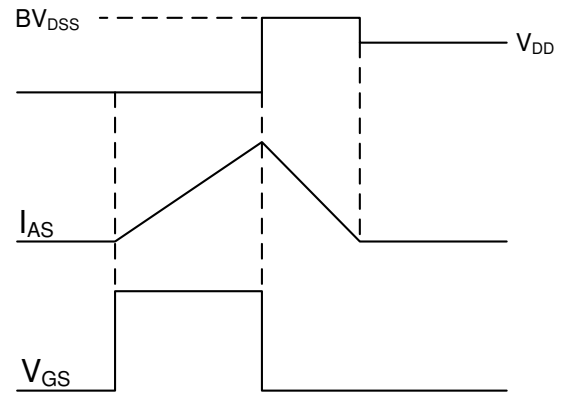
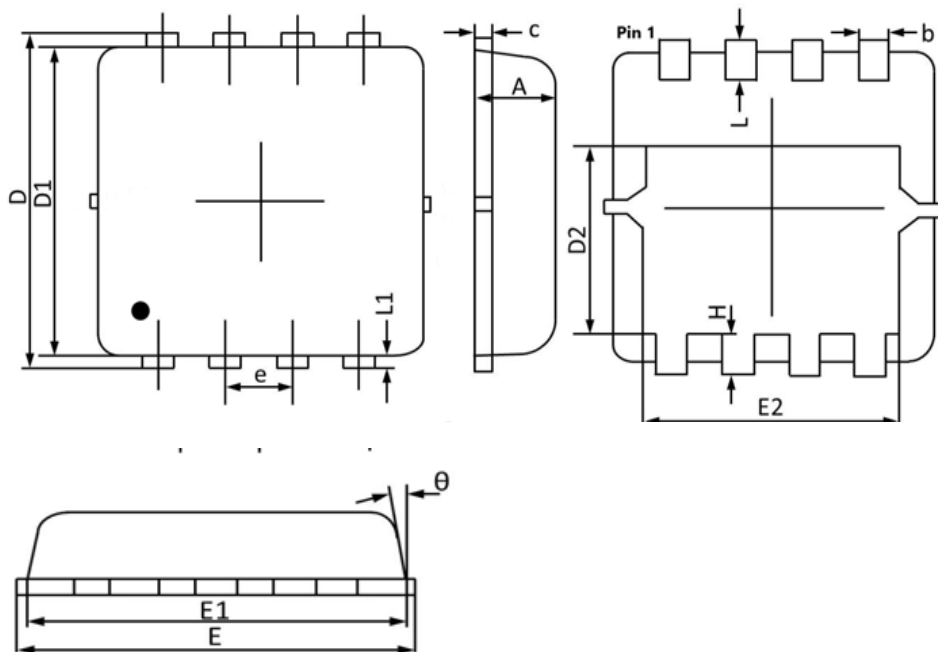

Fig.13 EAS Waveform

Package Outline Dimensions (PPAK3x3)



Symbol	Dimensions In Millimeters		Dimensions In Inches	
	MAX	MIN	MAX	MIN
A	0.900	0.700	0.035	0.028
b	0.350	0.240	0.014	0.009
c	0.250	0.100	0.010	0.004
D	3.450	3.050	0.136	0.120
D1	3.200	2.900	0.126	0.114
D2	1.850	1.350	0.073	0.053
E	3.400	3.000	0.134	0.118
E1	3.250	2.900	0.128	0.114
E2	2.600	2.350	0.102	0.093
e	0.65BSC		0.026BSC	
H	0.500	0.300	0.020	0.012
L	0.500	0.300	0.020	0.012
L1	0.200	0.070	0.008	0.003
θ	12°	0°	12°	0°

Recommended Pad Layout

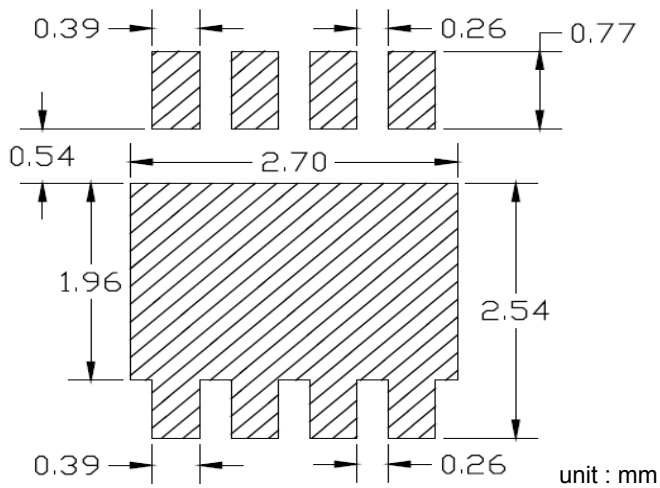

Order Information

Device	Package	Marking	Carrier	Quantity
GSFN0345	PPAK3x3	DC3963	Tape & Reel	3,000 pcs / Reel