

REVISIONS

P	LTR	DESCRIPTION	DATE	DWN	APVD
B		ECO-20-017853: G-CONTACT TAIL GOLD FLASH	18DEC2020	A.L	H.L

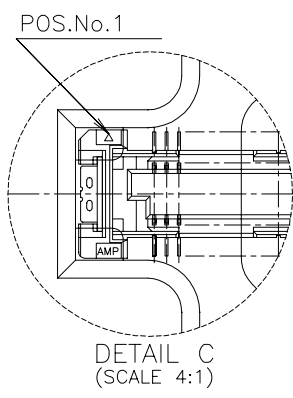
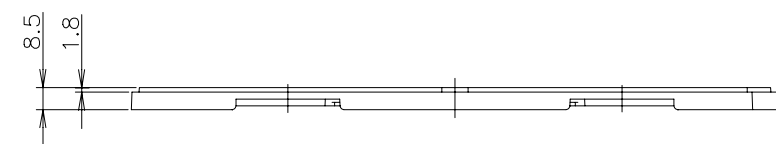
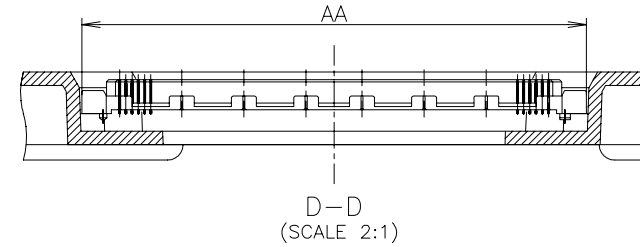
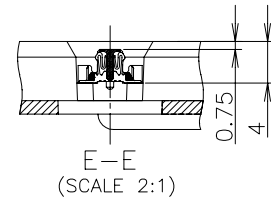
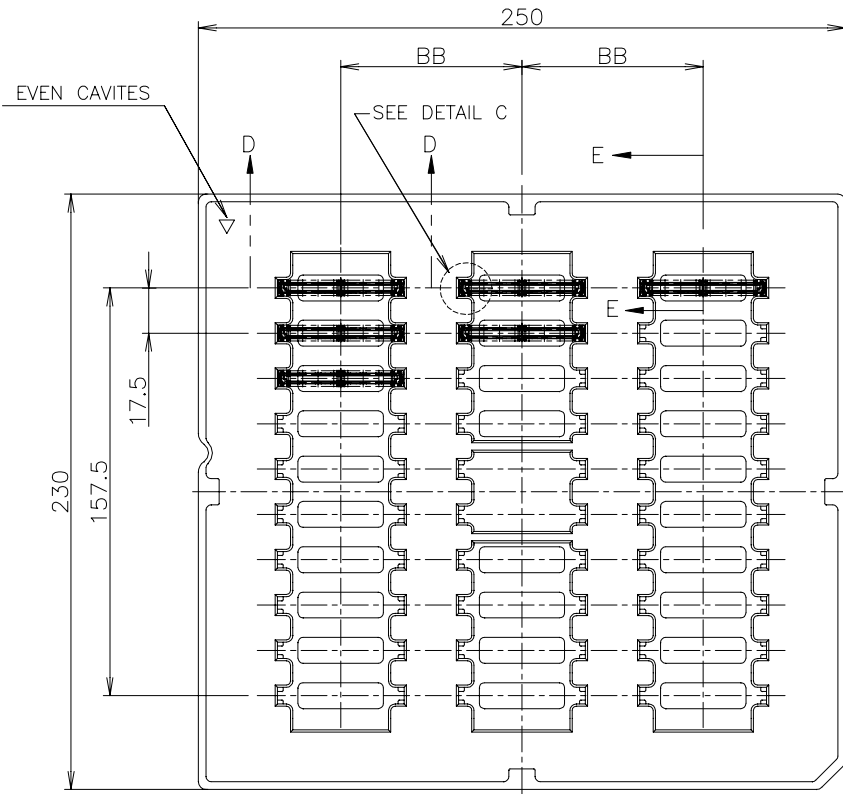

SEALANT	ROW	QTY	BB	AA	POS.	PART NO.
AVAILABLE	3	30	70	54.7	160	1-5316560-1
AVAILABLE	↑	↑	↑	48.7	140	1- -0
NOT AVAILABLE	↓	↓	↓	42.7	120	-9
NOT AVAILABLE	↓	↓	↓	36.7	100	-8
NOT AVAILABLE	3	30	70	33.7	90	-7
AVAILABLE	5	50	43	30.7	80	-6
NOT AVAILABLE	↑	↑	↑	27.7	70	-5
↑				24.7	60	-4
↑				21.7	50	-3
↓				18.7	40	-2
NOT AVAILABLE	5	50	43	15.7	30	5316560-1
TOOLING STATUS	ROW	QTY	BB	AA	POS.	PART NO.

THIS DRAWING IS A CONTROLLED DOCUMENT.

DWN LEO ZHOU 17NOV04
 CHK STEVEN YAO 17NOV04
 APVD I. ENOMOTO 17NOV04

PRODUCT SPEC 108-60047
 APPLICATION SPEC 114-5255
 WEIGHT

TE Connectivity Ltd.
 HARD TRAY ASSY
 FH 0.6BTB CONNECTOR
 REC 4H W/G-CONT

SIZE A3 CAGE CODE 00779 DRAWING NO. 5316560
 RESTRICTED TO

CUSTOMER DRAWING SCALE 1:2 SHEET 1 OF 3 REV B

GENERAL TOLERANCE 一般公差

10 ≥	±0.2
30 ≥	>10: ±0.25
100 ≥	>30: ±0.3

ANGLES: ±3°

DIMENSIONS: 單位: 耗 mm

TOLERANCES UNLESS OTHERWISE SPECIFIED: 一般公差

0 PLC	± -
1 PLC	± -
2 PLC	± -
3 PLC	± -
4 PLC	± -
ANGLES	± -

MATERIAL 材料 FINISH 仕上

P	LTR	DESCRIPTION	DATE	DWN	APVD
-	-	SEE SHEET 1	-	-	-

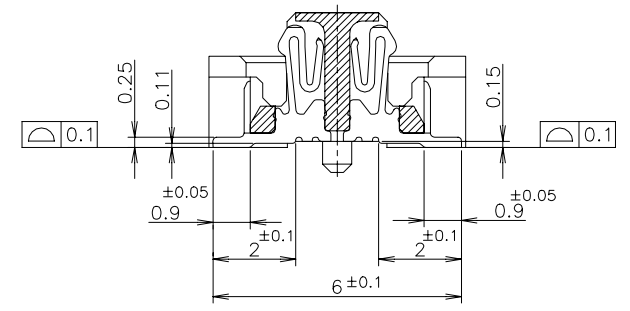
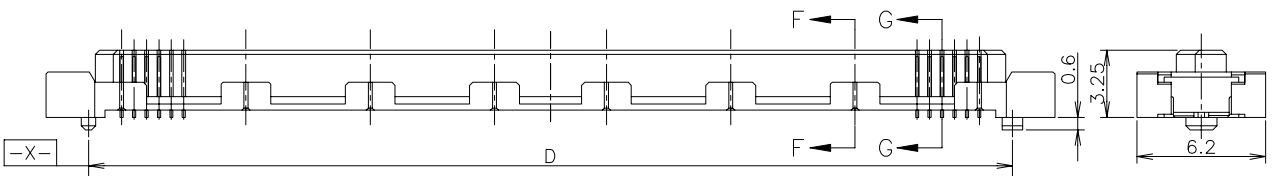
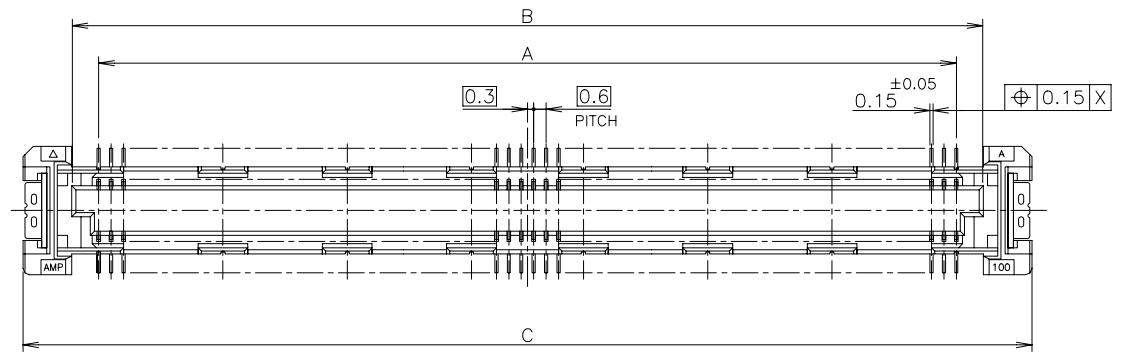

G-G
(SIGNAL POSITION)
(SCALE 8:1)

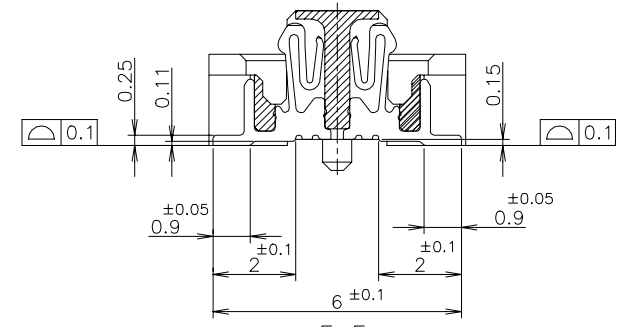
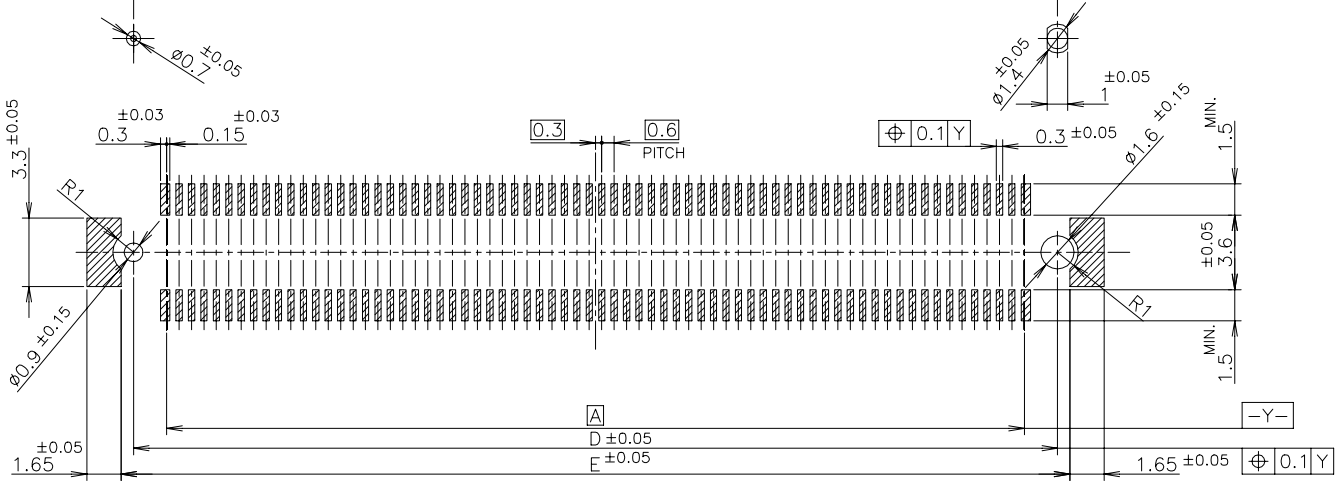

F-F
(GROUND POSITION)
(SCALE 8:1)

AVAILABLE	51.8	50.6	54.7	50	47.4	160	1-5316560-1
AVAILABLE	45.8	44.6	48.7	44	41.4	140	1-5316560-0
NOT AVAILABLE	39.8	38.6	42.7	38	35.4	120	-9
AVAILABLE	33.8	32.6	36.7	32	29.4	100	-8
NOT AVAILABLE	30.8	29.6	33.7	29	26.4	90	-7
AVAILABLE	27.8	26.6	30.7	26	23.4	80	-6
	24.8	23.6	27.7	23	20.4	70	-5
	21.8	20.6	24.7	20	17.4	60	-4
	18.8	17.6	21.7	17	14.4	50	-3
AVAILABLE	15.8	14.6	18.7	14	11.4	40	-2
NOT AVAILABLE	12.8	11.6	15.7	11	8.4	30	5316560-1
TOOLING STATUS	E	D	C	B	A	POS	△ PART NO.

REFERENCE P.C.BOARD LAYOUT

THIS DRAWING IS A CONTROLLED DOCUMENT.

DIMENSIONS: 單位: 耗 mm	TOLERANCES UNLESS OTHERWISE SPECIFIED: 一般公差	DWN	TE Connectivity Ltd. HARD TRAY ASSY FH 0.6BTB CONNECTOR REC 4H W/G-CONT
	0 PLC ± 0.3 1 PLC ± 0.3 2 PLC ± 0.3 3 PLC ± 0.3 4 PLC ± 0.3 ANGLES ± 3°	CHK	
MATERIAL 材料	FINISH 仕上	APVD	
		PRODUCT SPEC 製品規格 APPLICATION SPEC 取付適用規格	
		WEIGHT	NAME 名称
		CUSTOMER DRAWING	SIZE CAGE CODE DRAWING NO A3 00779 G=5316560
		SCALE 尺度 4:1	RESTRICTED TO
		SHEET 2 of 3	REV B

REVISIONS					
変更					
P	LTR	DESCRIPTION	DATE	DWN	APVD
-	-	SEE SHEET 1	-	-	-

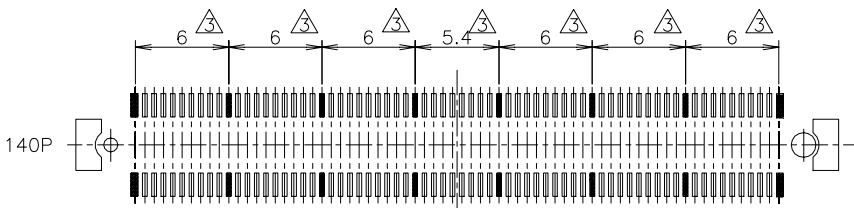
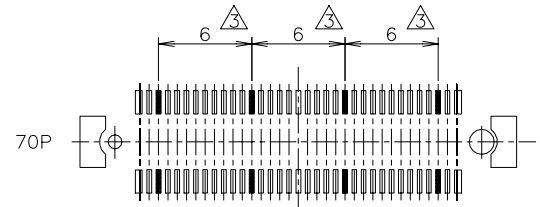
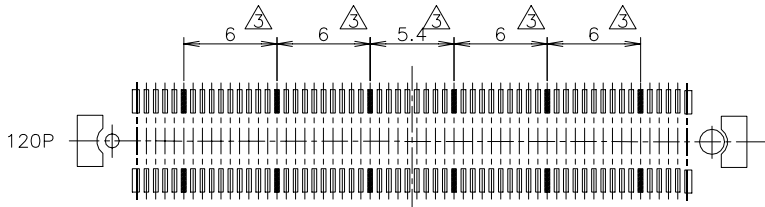
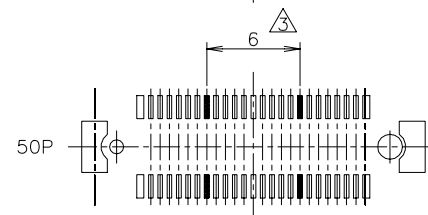
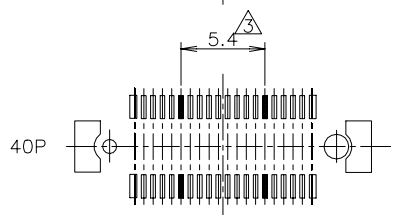
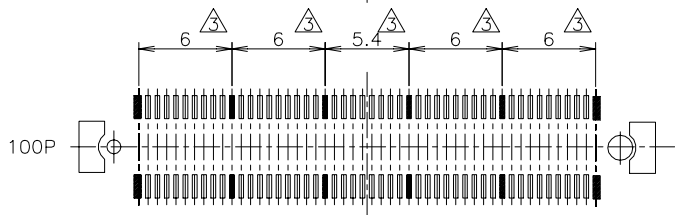
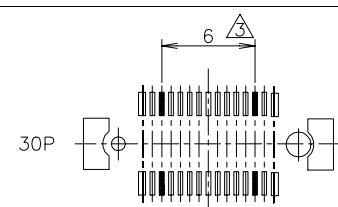
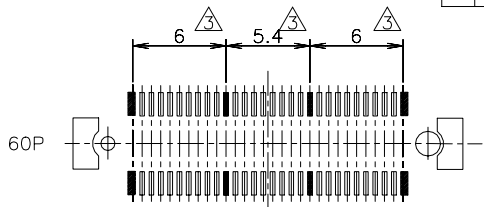
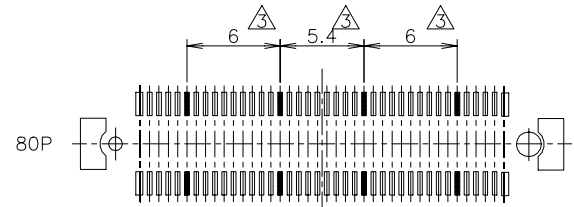

- △ MATERIAL ; HOUSING : HIGH TEMP THERMO PLASTIC
UL94V-0
- △ FINISH ; UNDER PL Ni 0.0013mm MIN ALL OVER.
CONTACT : COPPER ALLOY
CONTACT AREA 0.0002 MIN Au PL.
SOLDERING AREA: SIGNAL POS 0.00005 MIN Au PL.
GROUND POS 0.00005 MIN Au PL.
- △ THIS POSITION IS GROUND CIRCUIT.
- △ PACKING SEE SHEET 1.

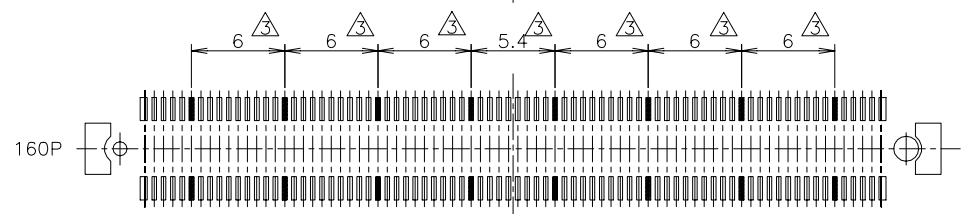

THIS DRAWING IS A CONTROLLED DOCUMENT.		DWN	TE TE Connectivity Ltd.	
DIMENSIONS: 單位: 耗 mm		CHK		
TOLERANCES UNLESS OTHERWISE SPECIFIED: 一般公差		APVD	NAME 名称	
0 PLC ± 0.3		PRODUCT SPEC 製品規格	HARD TRAY ASSY	
1 PLC ± 0.3		APPLICATION SPEC 取付適用規格	FH 0.6BTB CONNECTOR	
2 PLC ± 0.3		WEIGHT	REC 4H W/G-CONT	
3 PLC ± 0.3		CUSTOMER DRAWING	SIZE	RESTRICTED TO
4 PLC ± 0.3			A3	
ANGLES ± 3'			CAGE CODE	DRAWING NO
FINISH 仕上			00779	G=5316560
MATERIAL 材料			SCALE 尺度	SHEET
			3:1	3 OF 3
				REV
				B