

OPA858 5.5-GHz Gain Bandwidth Product, Gain of 7 V/V Stable, FET Input Amplifier

1 Features

- High Gain Bandwidth Product: 5.5 GHz
- Decompensated, Gain ≥ 7 V/V (Stable)
- Ultra-Low Bias Current MOSFET Inputs: 10 pA
- Low Input Voltage Noise: $2.5 \text{ nV}/\sqrt{\text{Hz}}$
- Slew rate: 2000 V/ μs
- Low Input Capacitance:
 - Common-Mode: 0.6 pF
 - Differential: 0.2 pF
- Wide Input Common-Mode Range:
 - 1.4 V from Positive Supply
 - Includes Negative Supply
- 2.5 V_{PP} Output Swing in TIA Configuration
- Supply Voltage Range: 3.3 V to 5.25 V
- Quiescent Current: 20.5 mA
- Available in 8-Pin WSON Package
- Temperature Range: -40 to $+125^\circ\text{C}$

2 Applications

- High-Speed Transimpedance Amplifier
- Laser Distance Measurement
- Lidar Receivers
- Level Transmitter (Optical)
- Optical Time Domain Reflectometry (OTDR)
- Distributed Temperature Sensing
- 3D Scanner
- Time-of-Flight (ToF) Systems
- Autonomous Driving Systems

3 Description

The OPA858 is a wideband, low-noise, operational amplifier with CMOS inputs for wideband transimpedance and voltage amplifier applications. When the device is configured as a transimpedance amplifier (TIA), the 5.5-GHz gain bandwidth product (GBWP) enables applications requiring high closed-loop bandwidths at transimpedance gains in the tens to hundreds of k Ω s range.

The graph below demonstrates the bandwidth and noise performance of the OPA858 as a function of the photodiode capacitance when the amplifier is configured as a TIA. The total noise is calculated over a bandwidth range extending from DC to the calculated $f_{-3\text{dB}}$ frequency on the left-hand scale. The OPA858 package features a feedback pin (FB) that simplifies the feedback network connection between the input and the output.

The OPA858 is optimized for use in optical Time-of-Flight (ToF) systems like the one shown in the figure below where the OPA858 is used with the [TDC7201](#) time-to-digital converter. The OPA858 can be used in high-resolution LIDAR systems with a high-speed analog-to-digital converter (ADC) and a differential output amplifier like the [THS4541](#) or [LMH5401](#) to drive the ADC.

Device Information⁽¹⁾

PART NUMBER	PACKAGE	BODY SIZE (NOM)
OPA858	WSON (8)	2.00 mm x 2.00 mm

(1) For all available packages, see the orderable addendum at the end of the data sheet.

High-Speed Time-of-Flight Receiver

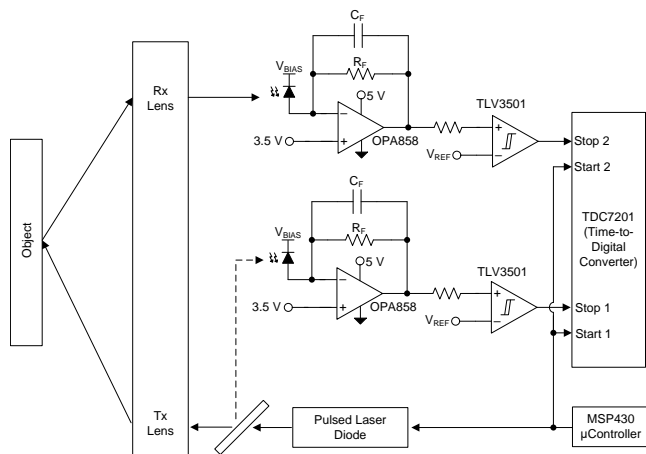

Photodiode Capacitance vs. Bandwidth and Noise

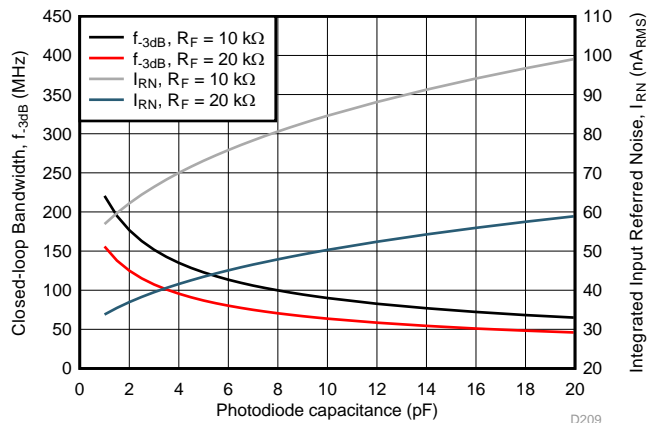

Table of Contents

1 Features	1	9.2 Functional Block Diagram	15
2 Applications	1	9.3 Feature Description	16
3 Description	1	9.4 Device Functional Modes	19
4 Revision History	2	10 Application and Implementation	20
5 Device Comparison Table	3	10.1 Application Information	20
6 Pin Configuration and Functions	3	10.2 Typical Application	22
7 Specifications	4	11 Power Supply Recommendations	24
7.1 Absolute Maximum Ratings	4	12 Layout	25
7.2 ESD Ratings	4	12.1 Layout Guidelines	25
7.3 Recommended Operating Conditions	4	12.2 Layout Example	25
7.4 Thermal Information	4	13 Device and Documentation Support	27
7.5 Electrical Characteristics	5	13.1 Receiving Notification of Documentation Updates	27
7.6 Typical Characteristics	7	13.2 Community Resources	27
8 Parameter Measurement Information	14	13.3 Trademarks	27
8.1 Parameter Measurement Information	14	13.4 Electrostatic Discharge Caution	27
9 Detailed Description	15	13.5 Glossary	27
9.1 Overview	15	14 Mechanical, Packaging, and Orderable Information	28

4 Revision History

NOTE: Page numbers for previous revisions may differ from page numbers in the current version.

Changes from Original (April 2018) to Revision A	Page
• Changed device status from "Advance Information" to "Production Data"	1

5 Device Comparison Table

DEVICE	INPUT TYPE	MINIMUM STABLE GAIN	VOLTAGE NOISE (nV/ $\sqrt{\text{Hz}}$)	INPUT CAPACITANCE (pF)	GAIN BANDWIDTH (GHz)
OPA858	CMOS	7 V/V	2.5	0.8	5.5
OPA855	Bipolar	7 V/V	0.98	0.8	8
LMH6629	Bipolar	10 V/V	0.69	5.7	4

6 Pin Configuration and Functions

DSG Package
8-Pin WSON With Exposed Thermal Pad
Top View

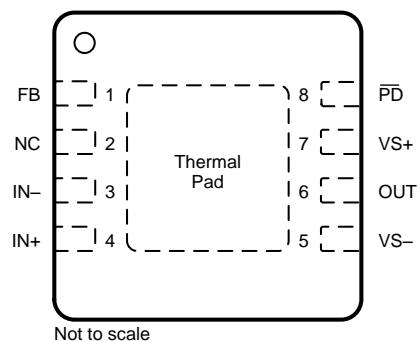

NC - no internal connection

Pin Functions

PIN		I/O	DESCRIPTION
NAME	NO.		
FB	1	I	Feedback connection to output of amplifier
IN-	3	I	Inverting input
IN+	4	I	Noninverting input
NC	2	—	Do not connect
OUT	6	O	Amplifier output
$\overline{\text{PD}}$	8	I	Power down connection. $\overline{\text{PD}}$ = logic low = power off mode; $\overline{\text{PD}}$ = logic high = normal operation
VS-	5	—	Negative voltage supply
VS+	7	—	Positive voltage supply
Thermal pad		—	Connect the thermal pad to VS-

7 Specifications

7.1 Absolute Maximum Ratings

over operating free-air temperature range (unless otherwise noted)⁽¹⁾

		MIN	MAX	UNIT
V _S	Total supply voltage (V _{S+} – V _{S-})		5.5	V
V _{IN+} , V _{IN-}	Input voltage	(V _{S-}) – 0.5	(V _{S+}) + 0.5	
V _{ID}	Differential input voltage		1	
V _{OUT}	Output voltage	(V _{S-}) – 0.5	(V _{S+}) + 0.5	
I _{IN}	Continuous input current		±10	mA
I _{OUT}	Continuous output current ⁽²⁾		±100	
T _J	Junction temperature		150	°C
T _A	Operating free-air temperature		125	
T _{STG}	Storage temperature	–65	150	

- (1) Stresses beyond those listed under *Absolute Maximum Ratings* may cause permanent damage to the device. These are stress ratings only, which do not imply functional operation of the device at these or any other conditions beyond those indicated under *Recommended Operating Conditions*. Exposure to absolute-maximum-rated conditions for extended periods may affect device reliability.
- (2) Long-term continuous output current for electromigration limits.

7.2 ESD Ratings

		VALUE	UNIT
V _(ESD)	Electrostatic discharge		V
	Human-body model (HBM), per ANSI/ESDA/JEDEC JS-001 ⁽¹⁾	±1000	
	Charged-device model (CDM), per JEDEC specification JESD22-C101 ⁽²⁾	±1500	

- (1) JEDEC document JEP155 states that 500-V HBM allows safe manufacturing with a standard ESD control process.
- (2) JEDEC document JEP157 states that 250-V CDM allows safe manufacturing with a standard ESD control process.

7.3 Recommended Operating Conditions

over operating free-air temperature range (unless otherwise noted)

		MIN	NOM	MAX	UNIT
V _S	Total supply voltage (V _{S+} – V _{S-})	3.3	5	5.25	V

7.4 Thermal Information

THERMAL METRIC ⁽¹⁾		OPA858	UNIT
		DSG (WSON)	
		8 PINS	
R _{θJA}	Junction-to-ambient thermal resistance	80.1	°C/W
R _{θJC(top)}	Junction-to-case (top) thermal resistance	100	°C/W
R _{θJB}	Junction-to-board thermal resistance	45	°C/W
ψ _{JT}	Junction-to-top characterization parameter	6.8	°C/W
ψ _{JB}	Junction-to-board characterization parameter	45.2	°C/W
R _{θJC(bot)}	Junction-to-case (bottom) thermal resistance	22.7	°C/W

- (1) For more information about traditional and new thermal metrics, see the [Semiconductor and IC Package Thermal Metrics](#) application report.

7.5 Electrical Characteristics

$V_{S+} = 5\text{ V}$, $V_{S-} = 0\text{ V}$, $G = 7\text{ V/V}$, $R_F = 453\ \Omega$, input common-mode biased at midsupply, $R_L = 200\ \Omega$, output load is referenced to midsupply, and $T_A = 25^\circ\text{C}$ (unless otherwise noted)

PARAMETER		TEST CONDITIONS	MIN	TYP	MAX	UNIT	TEST LEVEL ⁽¹⁾
AC PERFORMANCE							
SSBW	Small-signal bandwidth	$V_{OUT} = 100\text{ mV}_{PP}$		1.2		GHz	C
LSBW	Large-signal bandwidth	$V_{OUT} = 2\text{ V}_{PP}$		600		MHz	C
GBWP	Gain-bandwidth product			5.5		GHz	C
	Bandwidth for 0.1-dB flatness			130		MHz	C
SR	Slew rate (10% - 90%)	$V_{OUT} = 2\text{-V step}$		2000		V/ μs	C
t_r	Rise time	$V_{OUT} = 100\text{-mV step}$		0.3		ns	C
t_f	Fall time	$V_{OUT} = 100\text{-mV step}$		0.3		ns	C
	Settling time to 0.1%	$V_{OUT} = 2\text{-V step}$		8		ns	C
	Settling time to 0.001%	$V_{OUT} = 2\text{-V step}$		3000		ns	C
	Overshoot or undershoot	$V_{OUT} = 2\text{-V step}$		7%			C
	Overdrive recovery	2x output overdrive (0.1% recovery)		200		ns	C
HD2	Second-order harmonic distortion	$f = 10\text{ MHz}$, $V_{OUT} = 2\text{ V}_{PP}$		88		dBc	C
		$f = 100\text{ MHz}$, $V_{OUT} = 2\text{ V}_{PP}$		64			
HD3	Third-order harmonic distortion	$f = 10\text{ MHz}$, $V_{OUT} = 2\text{ V}_{PP}$		86		dBc	C
		$f = 100\text{ MHz}$, $V_{OUT} = 2\text{ V}_{PP}$		68			
e_n	Input-referred voltage noise	$f = 1\text{ MHz}$		2.5		nV/ $\sqrt{\text{Hz}}$	C
Z_{OUT}	Closed-loop output impedance	$f = 1\text{ MHz}$		0.15		Ω	C
DC PERFORMANCE							
A_{OL}	Open-loop voltage gain		72	75		dB	A
V_{OS}	Input offset voltage	$T_A = 25^\circ\text{C}$	-5	± 0.8	5	mV	A
$\Delta V_{OS}/\Delta T$	Input offset voltage drift	$T_A = -40^\circ\text{C}$ to $+125^\circ\text{C}$		± 2		$\mu\text{V}/^\circ\text{C}$	B
I_{BN} , I_{BI}	Input bias current	$T_A = 25^\circ\text{C}$		± 0.4	5	pA	A
I_{BOS}	Input offset current	$T_A = 25^\circ\text{C}$		± 0.01	5	pA	A
CMRR	Common-mode rejection ratio	$V_{CM} = \pm 0.5\text{ V}$, referenced to midsupply	70	90		dB	A
INPUT							
	Common-mode input resistance			1		G Ω	C
C_{CM}	Common-mode input capacitance			0.62		pF	C
	Differential input resistance			1		G Ω	C
C_{DIFF}	Differential input capacitance			0.2		pF	C
V_{IH}	Common-mode input range (high)	CMRR > 66 dB, $V_{S+} = 3.3\text{ V}$	1.7	1.9		V	A
V_{IL}	Common-mode input range (low)	CMRR > 66 dB, $V_{S+} = 3.3\text{ V}$		0	0.4	V	A
V_{IH}	Common-mode input range (high)	CMRR > 66 dB	3.4	3.6		V	A
		$T_A = -40^\circ\text{C}$ to $+125^\circ\text{C}$, CMRR > 66 dB		3.4			B
V_{IL}	Common-mode input range (low)	CMRR > 66 dB		0	0.4	V	A
		$T_A = -40^\circ\text{C}$ to $+125^\circ\text{C}$, CMRR > 66 dB		0.35			B
OUTPUT							
V_{OH}	Output voltage (high)	$T_A = 25^\circ\text{C}$, $V_{S+} = 3.3\text{ V}$	2.3	2.4		V	A
V_{OH}	Output voltage (high)	$T_A = 25^\circ\text{C}$	3.95	4.1		V	A
		$T_A = -40^\circ\text{C}$ to $+125^\circ\text{C}$		3.9			B
V_{OL}	Output voltage (low)	$T_A = 25^\circ\text{C}$, $V_{S+} = 3.3\text{ V}$		1.05	1.15	V	A

(1) Test levels (all values set by characterization and simulation): (A) 100% tested at 25°C, overtemperature limits by characterization and simulation; (B) Not tested in production, limits set by characterization and simulation; (C) Typical value only for information.

Electrical Characteristics (continued)

$V_{S+} = 5\text{ V}$, $V_{S-} = 0\text{ V}$, $G = 7\text{ V/V}$, $R_F = 453\ \Omega$, input common-mode biased at midsupply, $R_L = 200\ \Omega$, output load is referenced to midsupply, and $T_A = 25^\circ\text{C}$ (unless otherwise noted)

PARAMETER		TEST CONDITIONS	MIN	TYP	MAX	UNIT	TEST LEVEL ⁽¹⁾
V_{OL}	Output voltage (low)	$T_A = 25^\circ\text{C}$		1.05	1.15	V	A
		$T_A = -40^\circ\text{C}$ to $+125^\circ\text{C}$		1.2			B
	Linear output drive (sink and source)	$R_L = 10\ \Omega$, $A_{OL} > 60\text{ dB}$	65	80		mA	A
		$T_A = -40^\circ\text{C}$ to $+125^\circ\text{C}$, $R_L = 10\ \Omega$, $A_{OL} > 60\text{ dB}$		64			B
I_{SC}	Output short-circuit current		85	105		mA	A
POWER SUPPLY							
V_S	Operating voltage		3.3		5.25	V	A
I_Q	Quiescent current	$V_{S+} = 5\text{ V}$	18	20.5	24	mA	A
I_Q	Quiescent current	$V_{S+} = 3.3\text{ V}$	17.5	20	23.5	mA	A
I_Q	Quiescent current	$V_{S+} = 5.25\text{ V}$	18	21	24	mA	A
I_Q	Quiescent current	$T_A = 125^\circ\text{C}$		24.5		mA	B
I_Q	Quiescent current	$T_A = -40^\circ\text{C}$		18.5		mA	B
PSRR+	Positive power-supply rejection ratio		74	84		dB	A
PSRR-	Negative power-supply rejection ratio		70	80			
POWER DOWN							
	Disable voltage threshold	Amplifier OFF below this voltage	0.65	1		V	A
	Enable voltage threshold	Amplifier ON above this voltage		1.5	1.8	V	A
	Power-down quiescent current			70	140	μA	A
	$\overline{\text{PD}}$ bias current			70	200	μA	A
	Turnon time delay	Time to $V_{OUT} = 90\%$ of final value		13		ns	C
	Turnoff time delay			120		ns	C

7.6 Typical Characteristics

$V_{S+} = 2.5\text{ V}$, $V_{S-} = -2.5\text{ V}$, $V_{IN+} = 0\text{ V}$, $R_F = 453\ \Omega$, Gain = 7 V/V , $R_L = 200\ \Omega$, output load referenced to midsupply, and $T_A = 25^\circ\text{C}$ (unless otherwise noted)

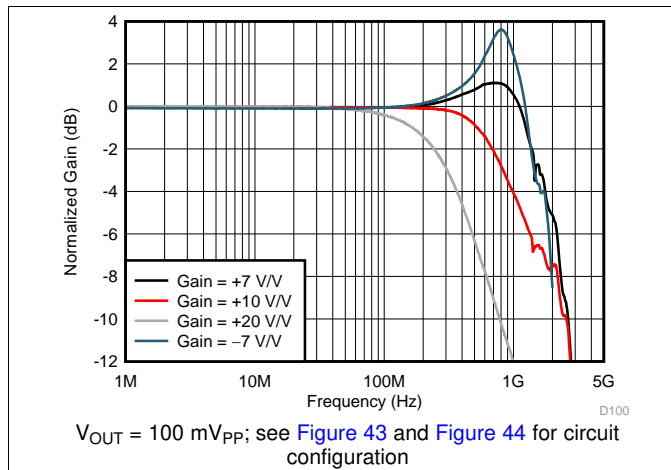

Figure 1. Small-Signal Frequency Response vs Gain

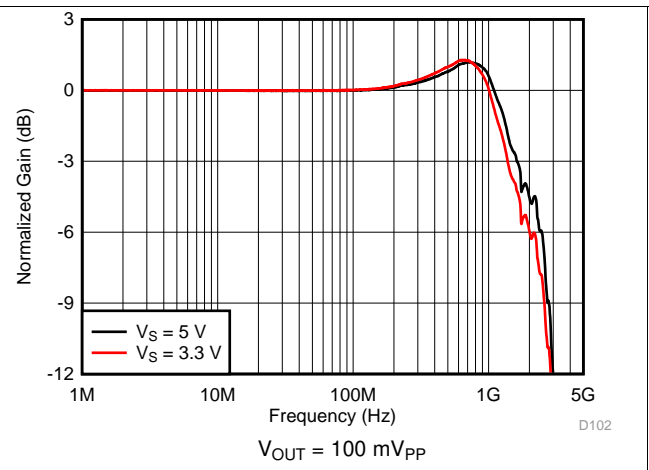

Figure 2. Small-Signal Frequency Response vs Supply Voltage

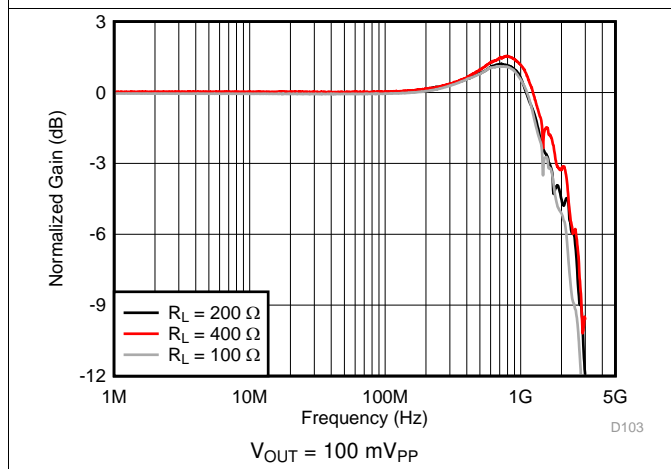

Figure 3. Small-Signal Frequency Response vs Output Load

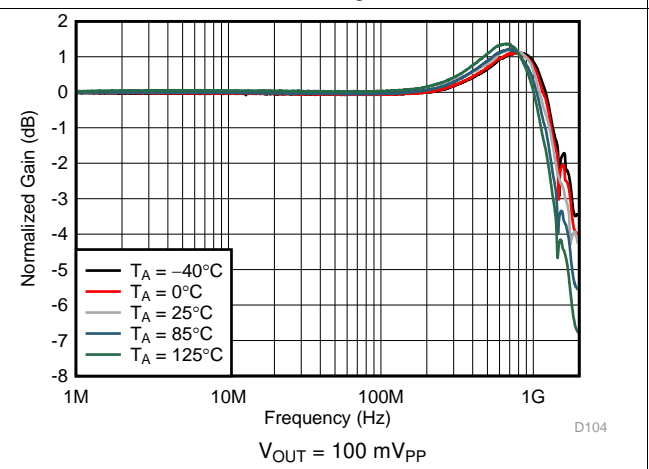

Figure 4. Small-Signal Frequency Response vs Ambient Temperature

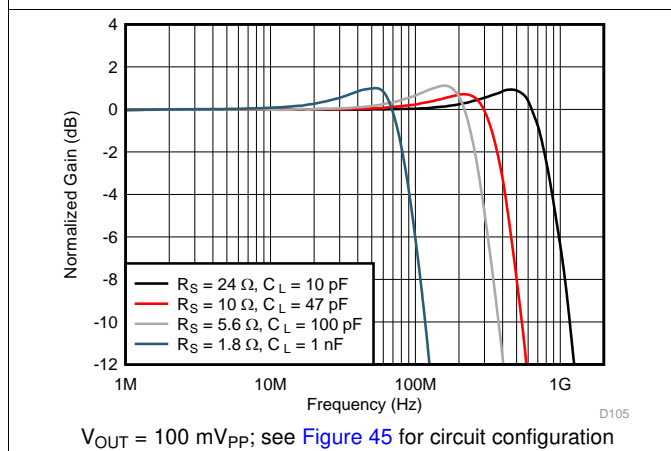

Figure 5. Small-Signal Frequency Response vs Capacitive Load

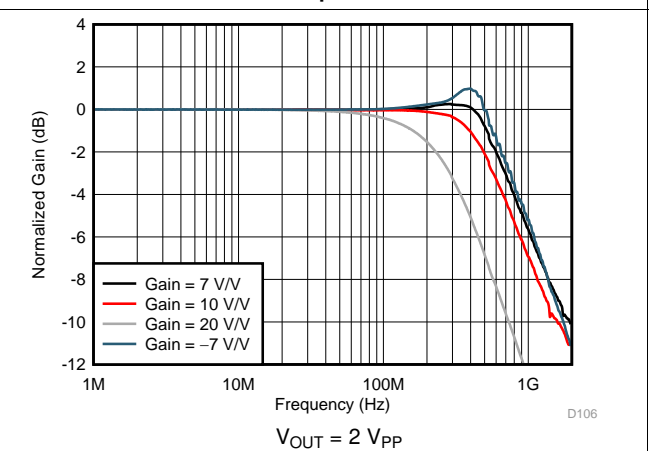

Figure 6. Large-Signal Frequency Response vs Gain

Typical Characteristics (continued)

$V_{S+} = 2.5\text{ V}$, $V_{S-} = -2.5\text{ V}$, $V_{IN+} = 0\text{ V}$, $R_F = 453\ \Omega$, Gain = 7 V/V, $R_L = 200\ \Omega$, output load referenced to midsupply, and $T_A = 25^\circ\text{C}$ (unless otherwise noted)

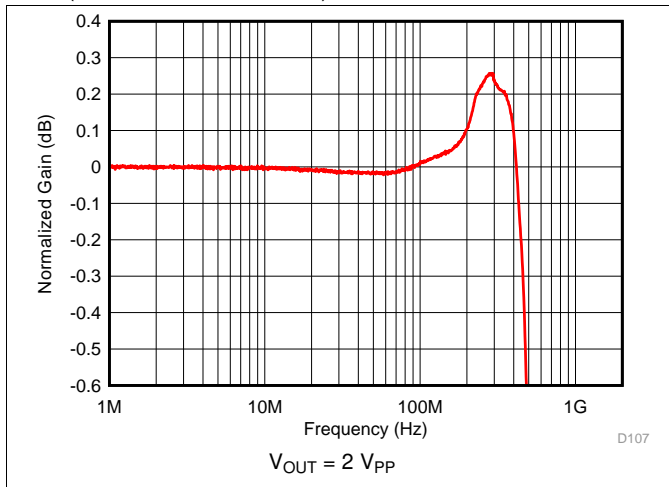

Figure 7. Large-Signal Response for 0.1-dB Gain Flatness

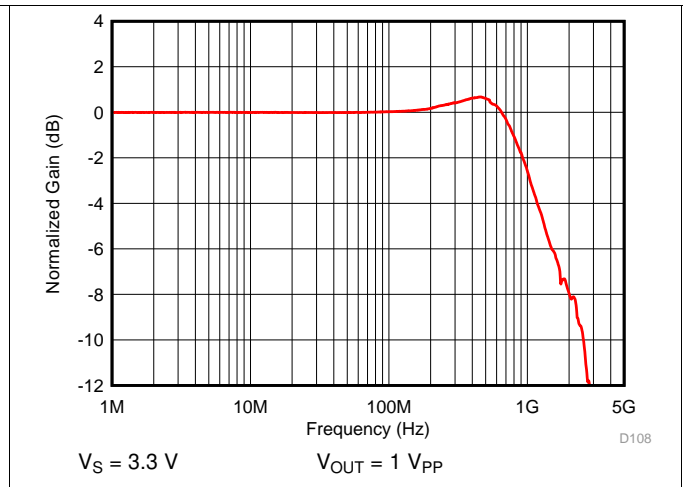

Figure 8. Large-Signal Frequency Response

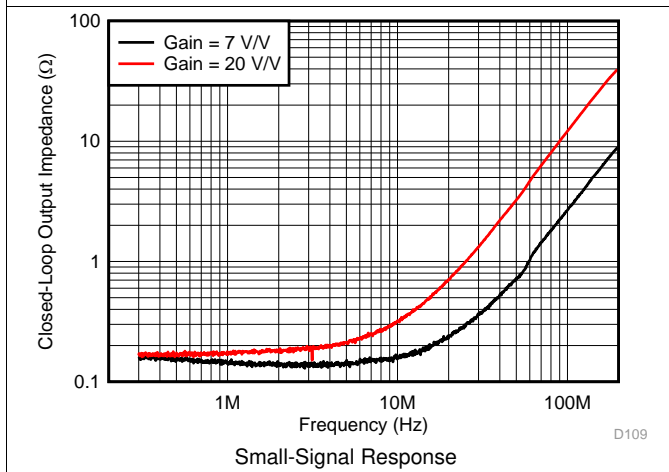

Figure 9. Closed-Loop Output Impedance vs Frequency

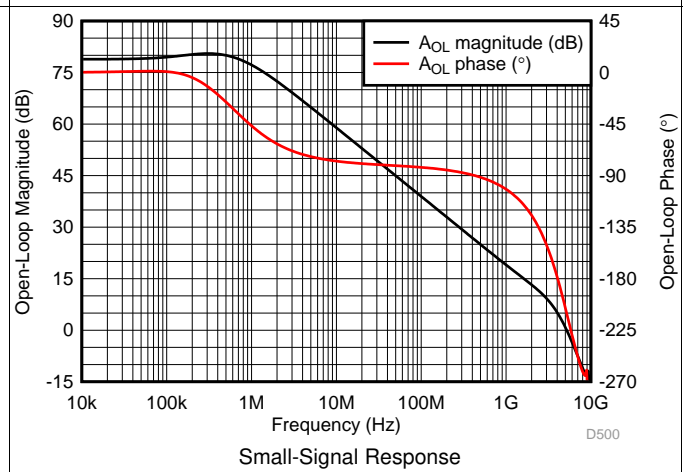

Figure 10. Open-Loop Magnitude and Phase vs Frequency

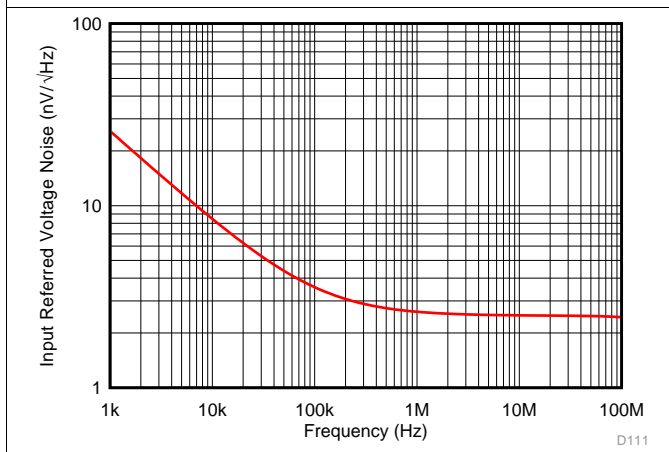

Figure 11. Voltage Noise Density vs Frequency

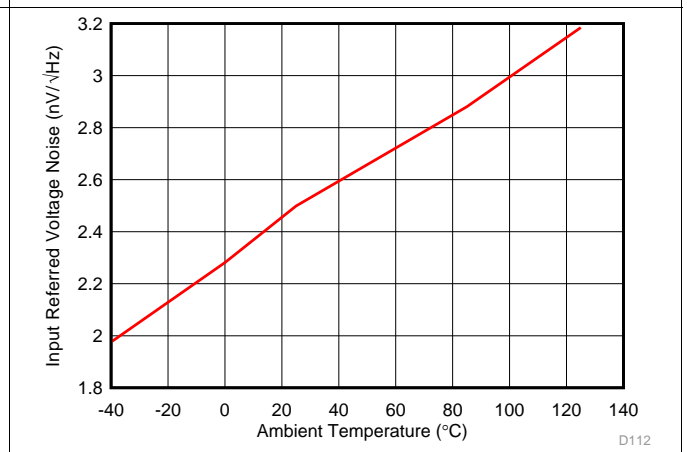

Figure 12. Voltage Noise Density vs Ambient Temperature

Typical Characteristics (continued)

$V_{S+} = 2.5\text{ V}$, $V_{S-} = -2.5\text{ V}$, $V_{IN+} = 0\text{ V}$, $R_F = 453\ \Omega$, Gain = 7 V/V, $R_L = 200\ \Omega$, output load referenced to midsupply, and $T_A = 25^\circ\text{C}$ (unless otherwise noted)

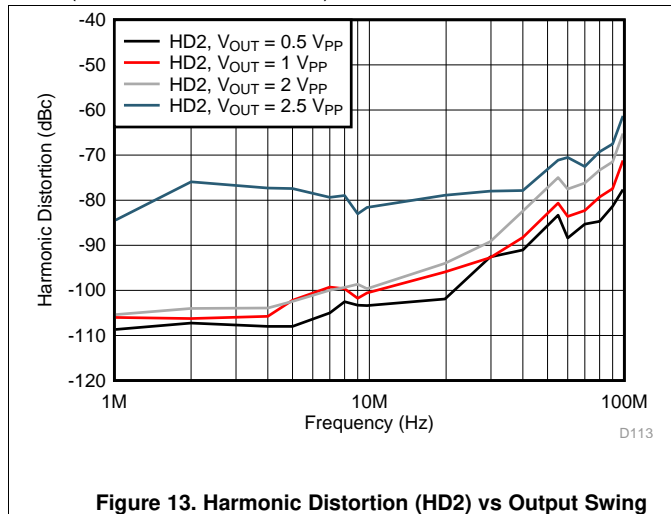

Figure 13. Harmonic Distortion (HD2) vs Output Swing

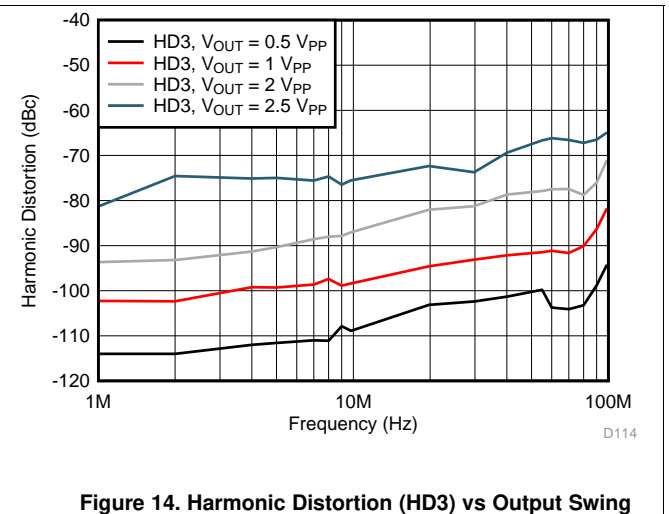

Figure 14. Harmonic Distortion (HD3) vs Output Swing

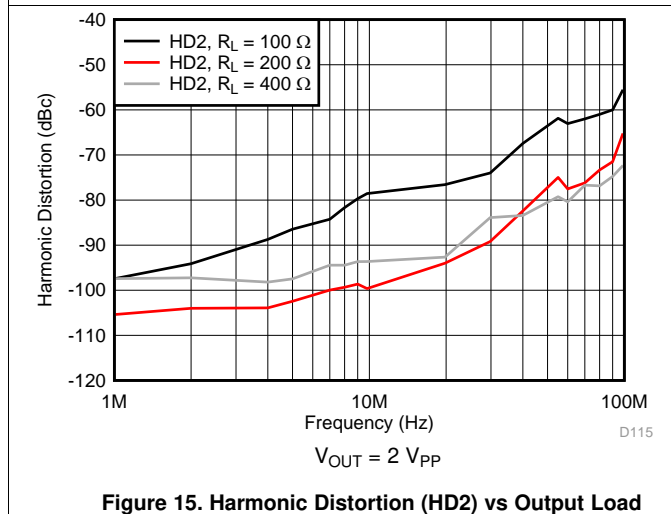

Figure 15. Harmonic Distortion (HD2) vs Output Load

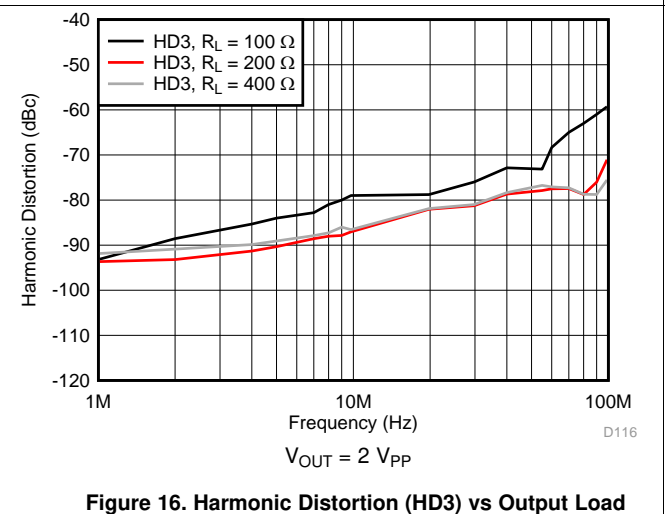

Figure 16. Harmonic Distortion (HD3) vs Output Load

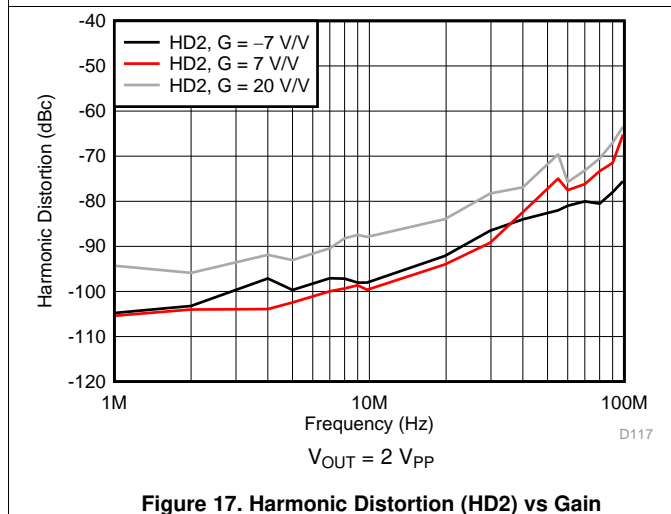

Figure 17. Harmonic Distortion (HD2) vs Gain

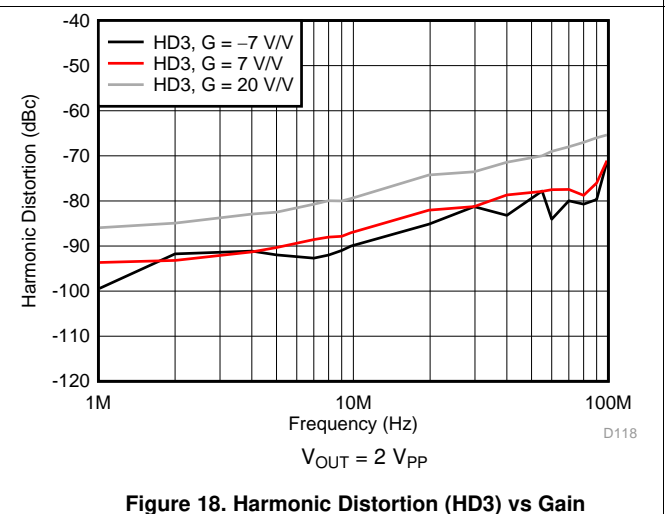
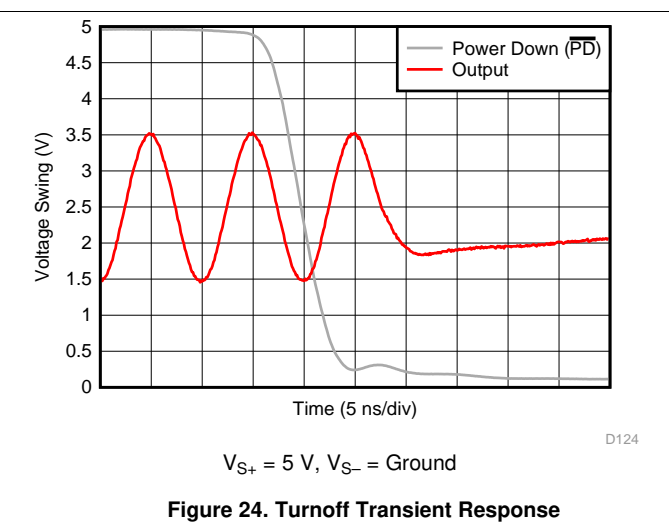
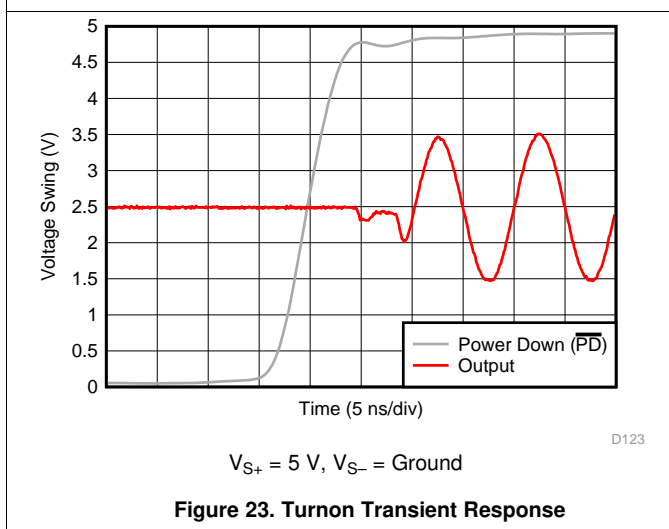
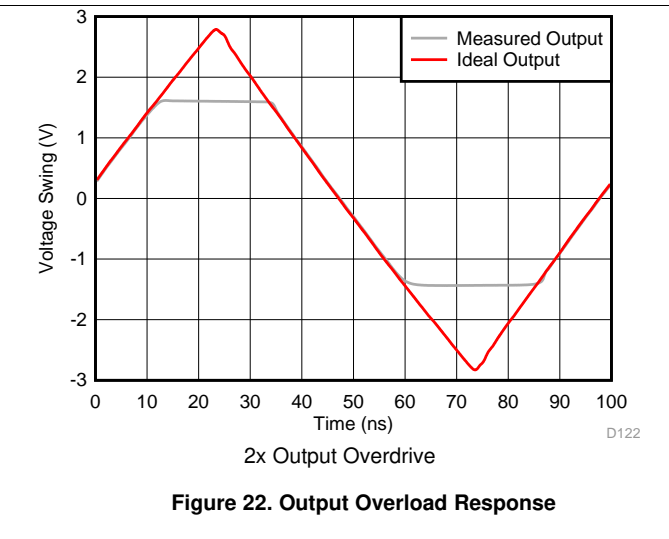
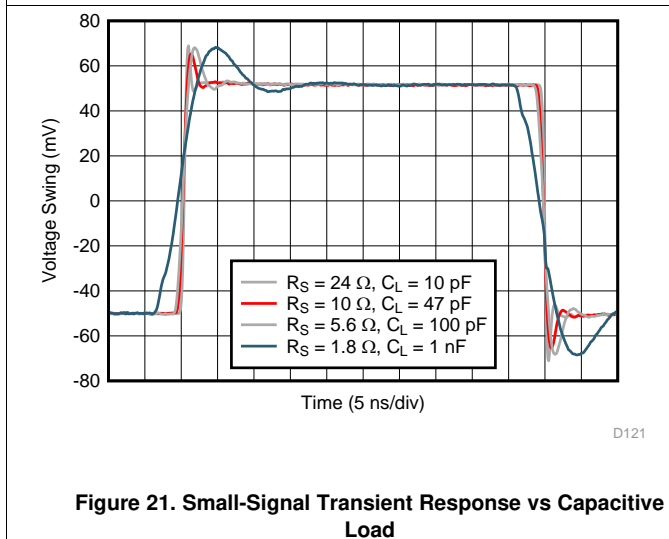
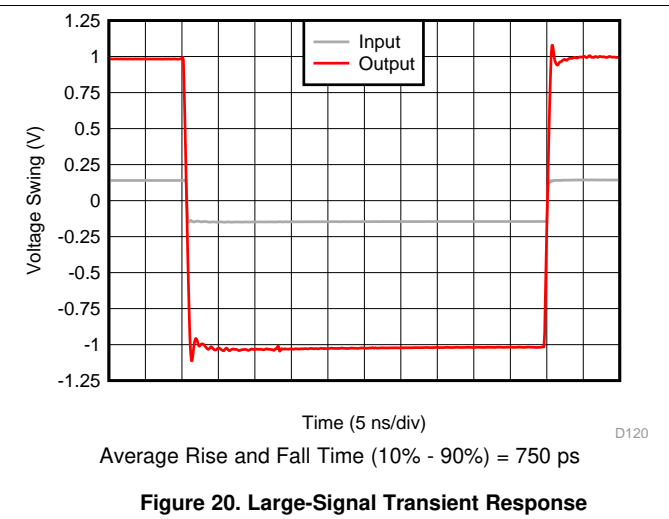
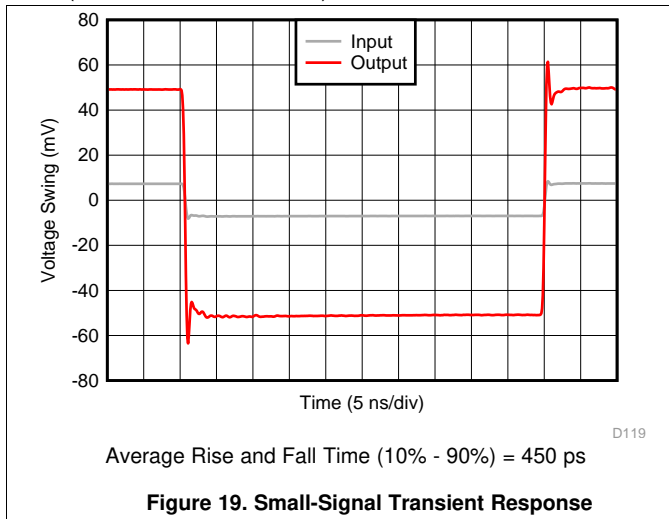

Figure 18. Harmonic Distortion (HD3) vs Gain

Typical Characteristics (continued)

$V_{S+} = 2.5\text{ V}$, $V_{S-} = -2.5\text{ V}$, $V_{IN+} = 0\text{ V}$, $R_F = 453\ \Omega$, Gain = 7 V/V, $R_L = 200\ \Omega$, output load referenced to midsupply, and $T_A = 25^\circ\text{C}$ (unless otherwise noted)



Typical Characteristics (continued)

$V_{S+} = 2.5\text{ V}$, $V_{S-} = -2.5\text{ V}$, $V_{IN+} = 0\text{ V}$, $R_F = 453\ \Omega$, Gain = 7 V/V, $R_L = 200\ \Omega$, output load referenced to midsupply, and $T_A = 25^\circ\text{C}$ (unless otherwise noted)

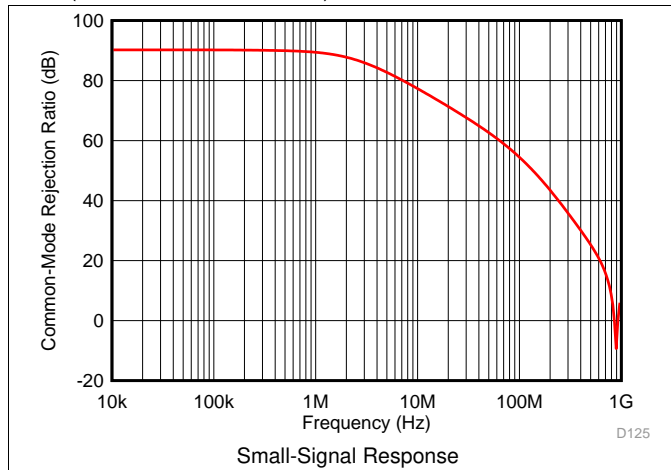

Figure 25. Common-Mode Rejection Ratio vs Frequency

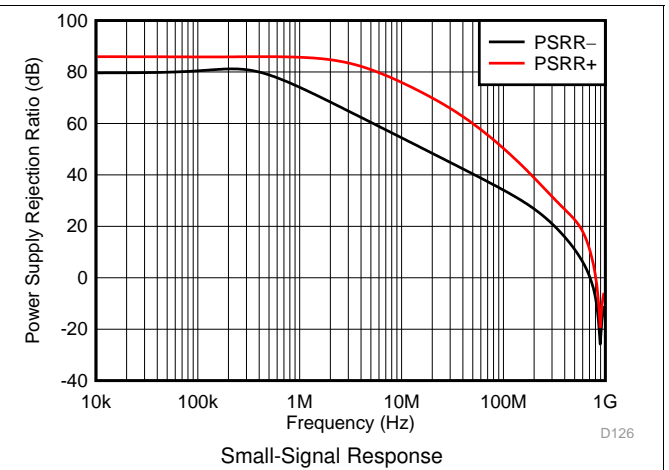

Figure 26. Power Supply Rejection Ratio vs Frequency

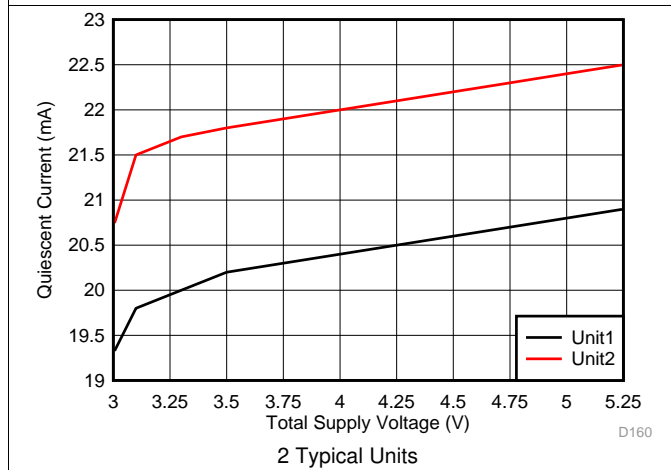

Figure 27. Quiescent Current vs Supply Voltage

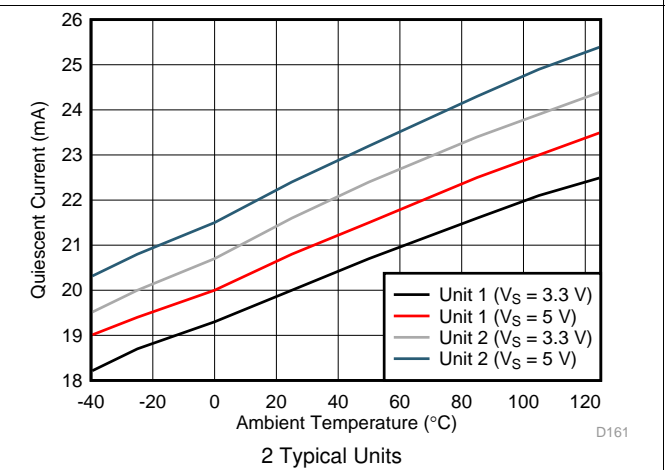

Figure 28. Quiescent Current vs Ambient Temperature

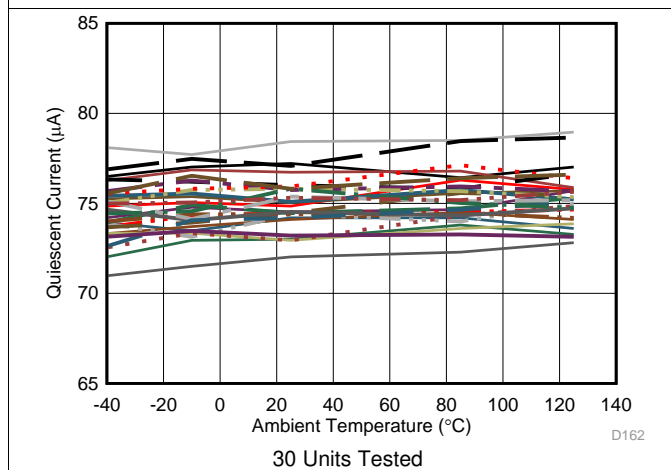

Figure 29. Quiescent Current (Amplifier Disabled) vs Ambient Temperature

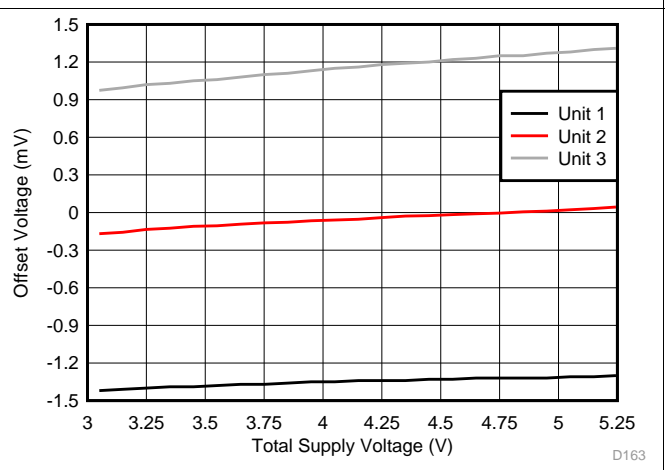
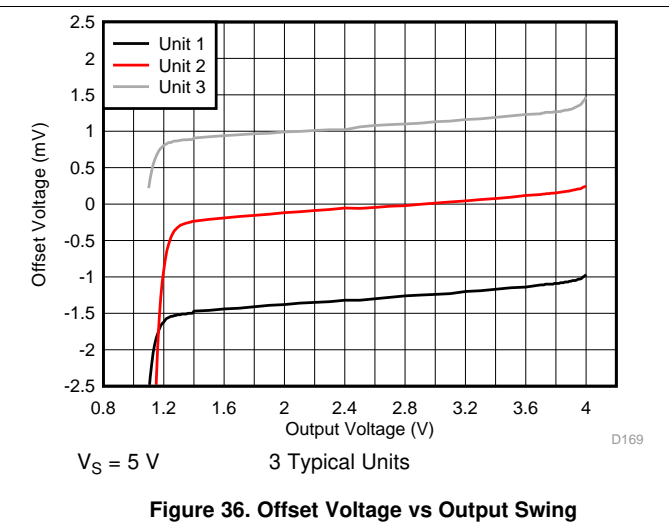
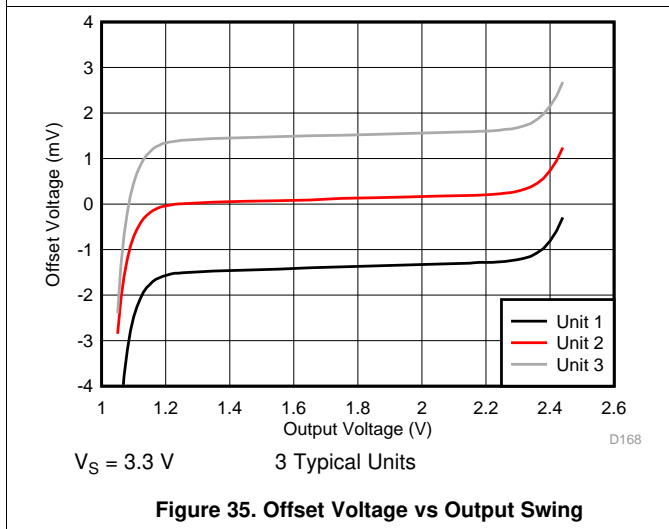
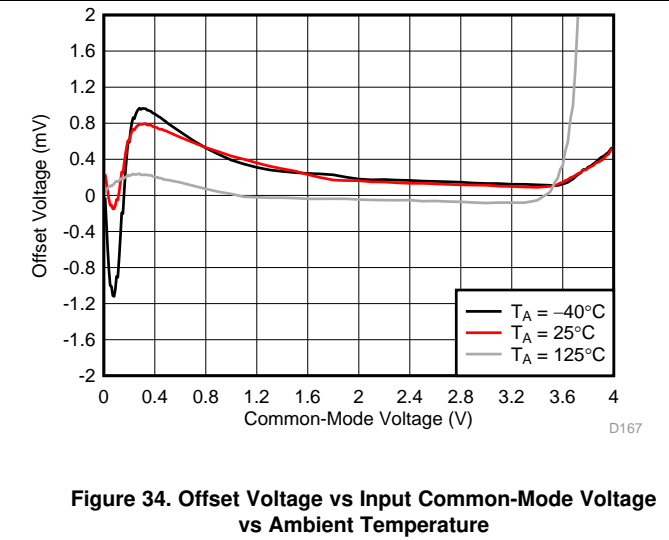
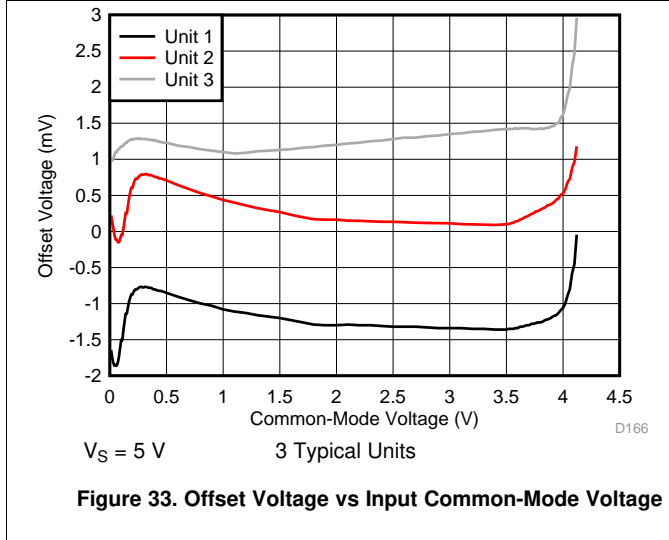
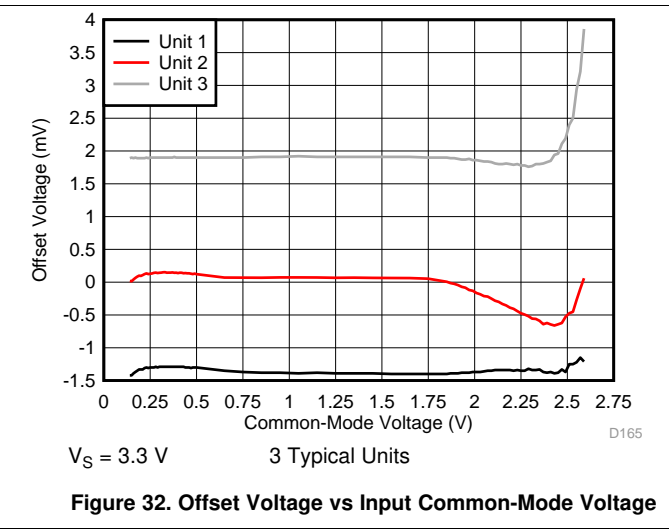
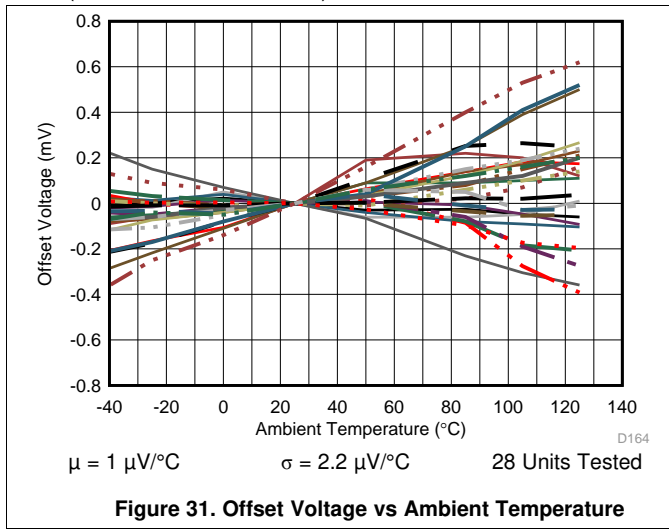

Figure 30. Offset Voltage vs Supply Voltage

Typical Characteristics (continued)

$V_{S+} = 2.5\text{ V}$, $V_{S-} = -2.5\text{ V}$, $V_{IN+} = 0\text{ V}$, $R_F = 453\ \Omega$, Gain = 7 V/V, $R_L = 200\ \Omega$, output load referenced to midsupply, and $T_A = 25^\circ\text{C}$ (unless otherwise noted)



Typical Characteristics (continued)

$V_{S+} = 2.5\text{ V}$, $V_{S-} = -2.5\text{ V}$, $V_{IN+} = 0\text{ V}$, $R_F = 453\ \Omega$, Gain = 7 V/V, $R_L = 200\ \Omega$, output load referenced to midsupply, and $T_A = 25^\circ\text{C}$ (unless otherwise noted)

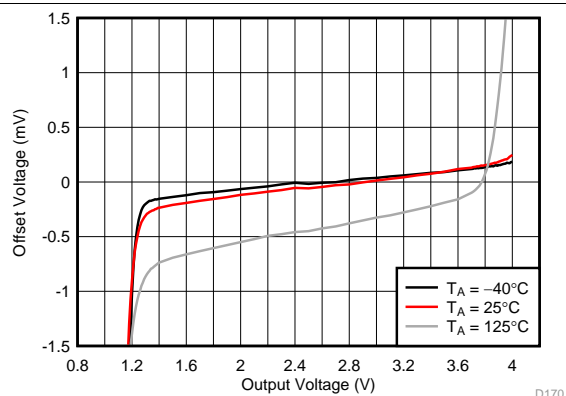

Figure 37. Offset Voltage vs Output Swing vs Ambient Temperature

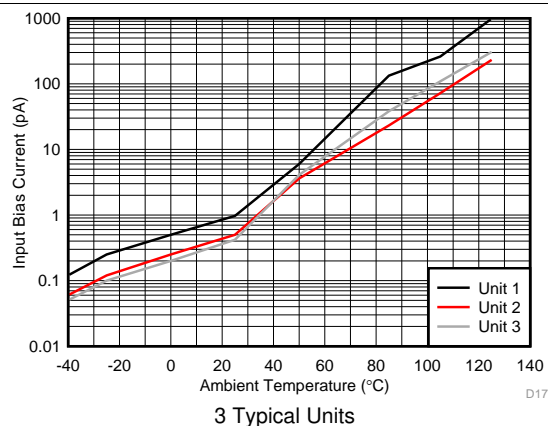

Figure 38. Input Bias Current vs Ambient Temperature

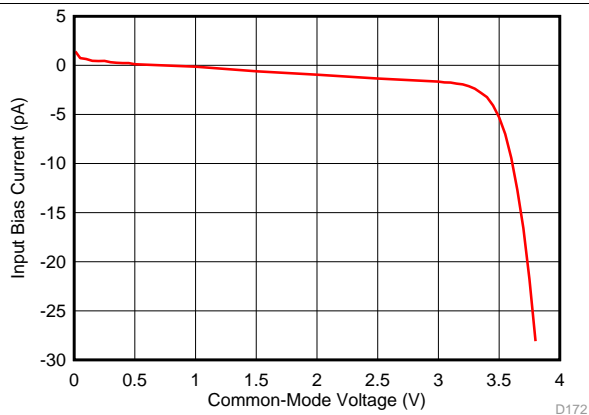

Figure 39. Input Bias Current vs Input Common-Mode Voltage

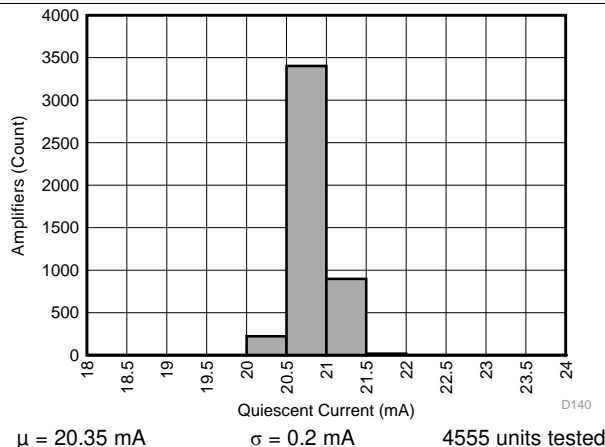

Figure 40. Quiescent Current Distribution

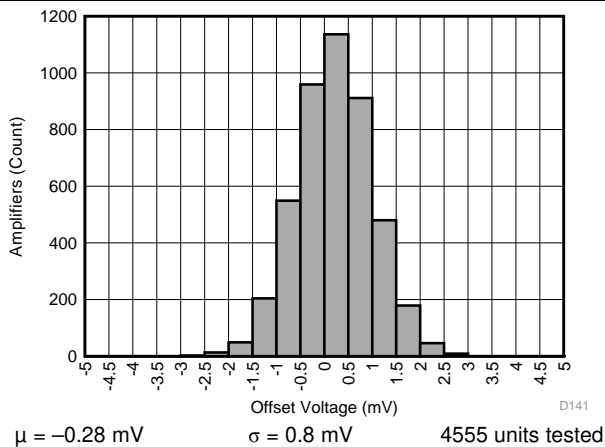

Figure 41. Offset Voltage Distribution

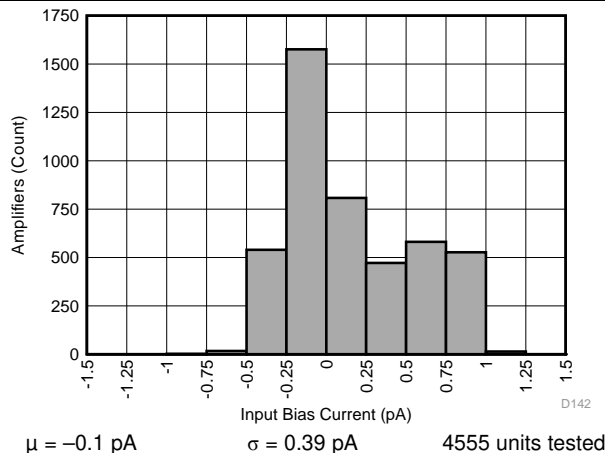
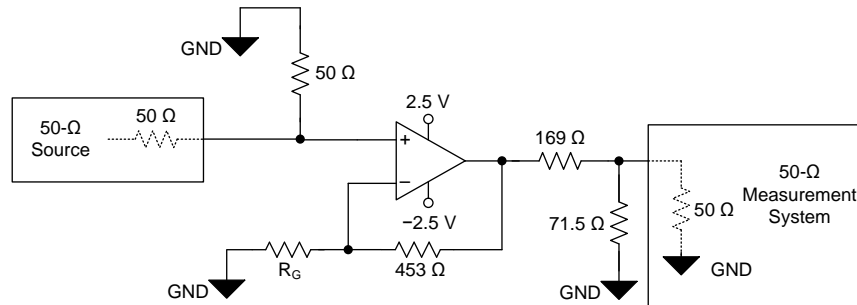

Figure 42. Input Bias Current Distribution

8 Parameter Measurement Information

8.1 Parameter Measurement Information

The various test setup configurations for the OPA858 are shown below



R_G values depend on gain configuration

Figure 43. Noninverting Configuration

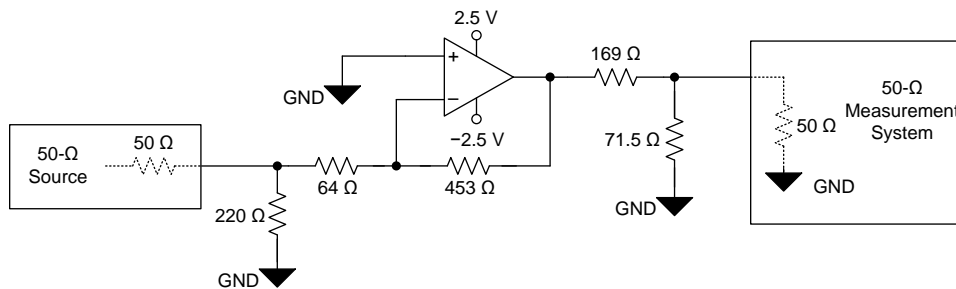

Figure 44. Inverting Configuration (Gain = -7 V/V)

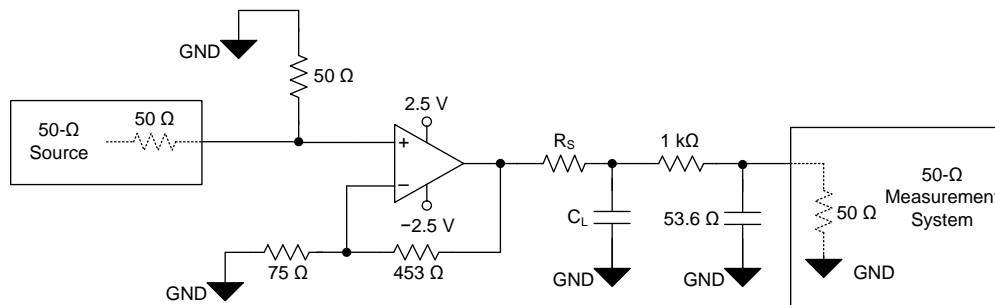

Figure 45. Capacitive Load Driver Configuration

9 Detailed Description

9.1 Overview

The ultra-wide, 5.5-GHz gain bandwidth product (GBWP) of the OPA858, combined with the broadband voltage noise of $2.5 \text{ nV}/\sqrt{\text{Hz}}$, produces a viable amplifier for wideband transimpedance applications, high-speed data acquisition systems, and applications with weak signal inputs that require low-noise and high-gain front ends. The OPA858 combines multiple features to optimize dynamic performance. In addition to the wide, small-signal bandwidth, the OPA858 has 600 MHz of large signal bandwidth ($V_{\text{OUT}} = 2 V_{\text{PP}}$) and a slew rate of $2000 \text{ V}/\mu\text{s}$.

The OPA858 is offered in a 2-mm × 2-mm, 8-pin WSON package that features a feedback (FB) pin for a simple feedback network connection between the amplifiers output and inverting input. Excess capacitance on an amplifiers input pin can reduce phase margin causing instability. This problem is exacerbated in the case of very wideband amplifiers like the OPA858. To reduce the effects of stray capacitance on the input node, the OPA858 pinout features an isolation pin (NC) between the feedback and inverting input pins that increases the physical spacing between them thereby reducing parasitic coupling at high frequencies. The OPA858 also features a very low capacitance input stage with only 0.8-pF of total input capacitance.

9.2 Functional Block Diagram

The OPA858 is a classic, voltage feedback operational amplifier (op amp) with two high-impedance inputs and a low-impedance output. Standard application circuits are supported, like the two basic options shown in [Figure 46](#) and [Figure 47](#). The DC operating point for each configuration is level-shifted by the reference voltage (V_{REF}), which is typically set to midsupply in single-supply operation. V_{REF} is typically connected to ground in split-supply applications.

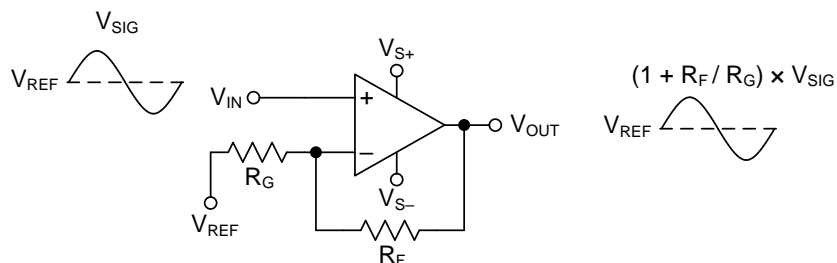

Figure 46. Noninverting Amplifier

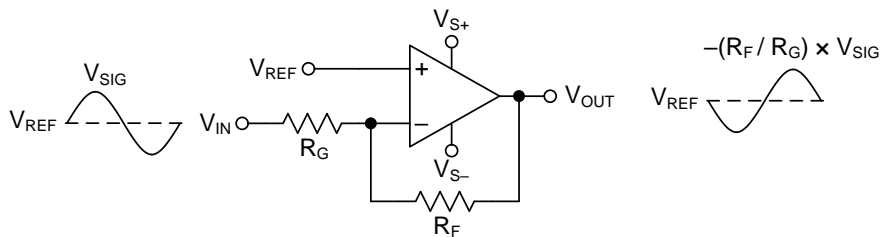

Figure 47. Inverting Amplifier

9.3 Feature Description

9.3.1 Input and ESD Protection

The OPA858 is fabricated on a low-voltage, high-speed, BiCMOS process. The internal, junction breakdown voltages are low for these small geometry devices, and as a result, all device pins are protected with internal ESD protection diodes to the power supplies as [Figure 48](#) shows. There are two antiparallel diodes between the inputs of the amplifier that clamp the inputs during an overrange or fault condition.

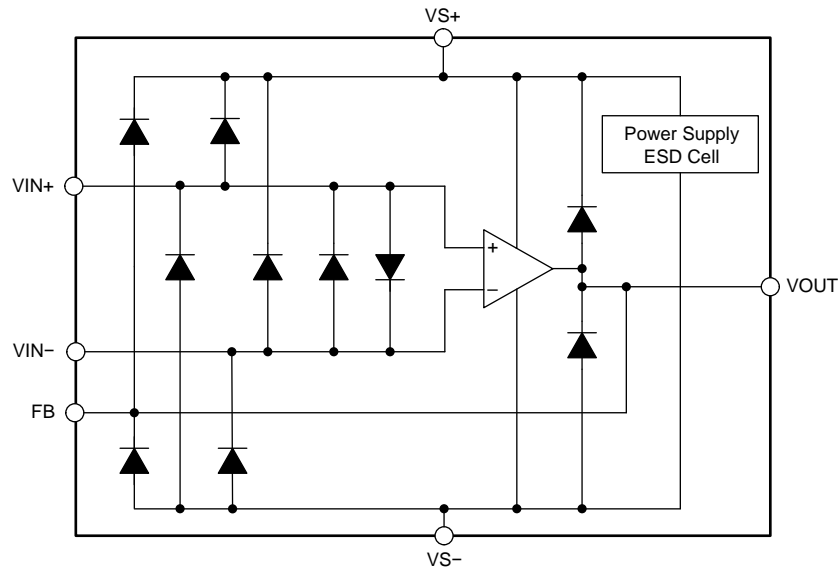

Figure 48. Internal ESD Structure

9.3.2 Feedback Pin

The OPA858 pin layout is optimized to minimize parasitic inductance and capacitance, which is critical in high-speed analog design. The FB pin (pin 1) is internally connected to the output of the amplifier. The FB pin is separated from the inverting input of the amplifier (pin 3) by a no connect (NC) pin (pin 2). The NC pin must be left floating. There are two advantages to this pin layout:

1. A feedback resistor (R_F) can connect between the FB and $IN-$ pin on the same side of the package (see [Figure 49](#)) rather than going around the package.
2. The isolation created by the NC pin minimizes the capacitive coupling between the FB and $IN-$ pins by increasing the physical separation between the pins.

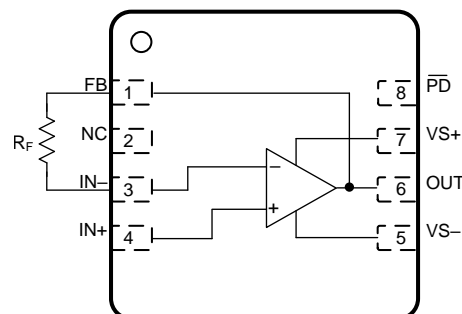

Figure 49. R_F Connection Between FB and $IN-$ Pins

Feature Description (continued)

9.3.3 Wide Gain-Bandwidth Product

Figure 10 shows the open-loop magnitude and phase response of the OPA858. Calculate the gain bandwidth product of any op amp by determining the frequency at which the A_{OL} is 60 dB and multiplying that frequency by a factor of 1000. The second pole in the A_{OL} response occurs before the magnitude crosses 0 dB, and the resultant phase margin is less than 0° . This indicates instability at a gain of 0 dB (1 V/V). Amplifiers that are not unity-gain stable are known as decompensated amplifiers. Decompensated amplifiers typically have higher gain-bandwidth product, higher slew rate, and lower voltage noise, compared to a unity-gain stable amplifier with the same amount of quiescent power consumption.

Figure 50 shows the open-loop magnitude (A_{OL}) of the OPA858 as a function of temperature. The results show minimal variation over temperature. The phase margin of the OPA858 configured in a noise gain of 7 V/V (16.9 dB) is close to 55° across temperature. Similarly Figure 51 shows the A_{OL} magnitude of the OPA858 as a function of process variation. The results show the A_{OL} curve for the nominal process corner and the variation one standard deviation from the nominal. The simulated results suggest less than 1° of phase margin difference within a standard deviation of process variation when the amplifier is configured in a gain of 7 V/V.

One of the primary applications for the OPA858 is as a high-speed transimpedance amplifier (TIA), as Figure 59 shows. The low-frequency noise gain of a TIA is 0 dB (1 V/V). At high frequencies the ratio of the total input capacitance and the feedback capacitance set the noise gain. To maximize the TIA closed-loop bandwidth, the feedback capacitance is typically smaller than the input capacitance, which implies that the high-frequency noise gain is greater than 0 dB. As a result, op amps configured as TIAs are not required to be unity-gain stable, which makes a decompensated amplifier a viable option for a TIA. [What You Need To Know About Transimpedance Amplifiers – Part 1](#) and [What You Need To Know About Transimpedance Amplifiers – Part 2](#) describe transimpedance amplifier compensation in greater detail.

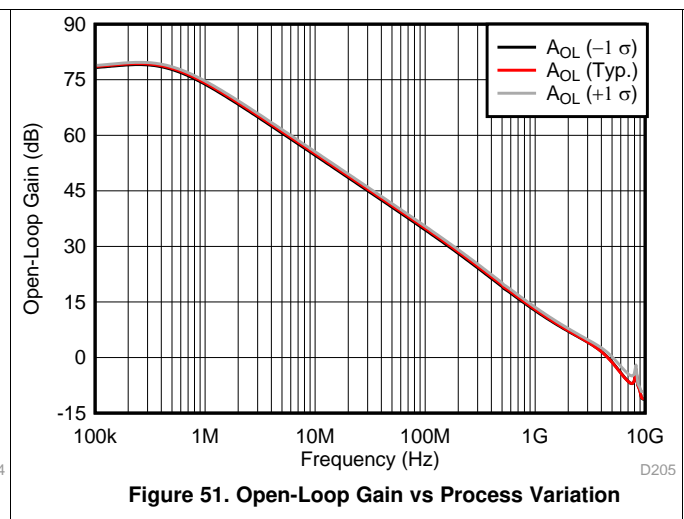
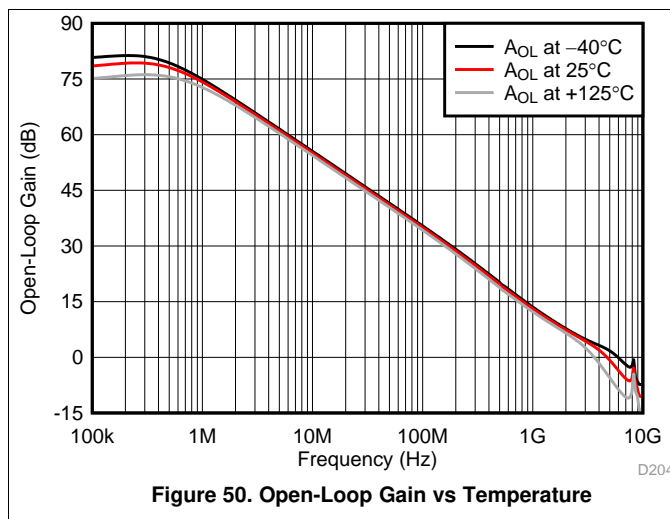

9.3.4 Slew Rate and Output Stage

In addition to wide bandwidth, the OPA858 features a high slew rate of $2000 \text{ V}/\mu\text{s}$. The slew rate is a critical parameter in high-speed pulse applications with narrow sub 10-ns pulses such as Optical Time-Domain Reflectometry (OTDR) and LIDAR. The high slew rate of the OPA858 implies that the device accurately reproduces a 2-V, sub-ns pulse edge as seen in Figure 20. The wide bandwidth and slew rate of the OPA858 make it an ideal amplifier for high-speed, signal-chain front ends.

Figure 52 shows the open-loop output impedance of the OPA858 as a function of frequency. To achieve high slew rates and low output impedance across frequency, the output swing of the OPA858 is limited to approximately 3 V. The OPA858 is typically used in conjunction with high-speed pipeline ADCs and flash ADCs that have limited input ranges. Therefore, the OPA858 output swing range coupled with the class-leading voltage noise specification maximizes the overall dynamic range of the signal chain.

Feature Description (continued)

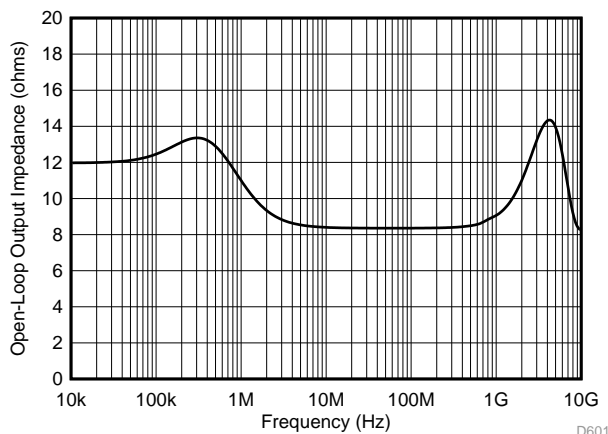

Figure 52. Open-Loop Output Impedance (Z_{OL}) vs Frequency

9.3.5 Current Noise

The input impedance of CMOS and JFET input amplifiers at low frequencies exceed several $G\Omega$ s. However, at higher frequencies, the transistors parasitic capacitance to the drain, source, and substrate reduces the impedance. The high impedance at low frequencies eliminates any bias current and the associated shot noise. At higher frequencies, the input current noise increases (see Figure 53) as a result of capacitive coupling between the CMOS gate oxide and the underlying transistor channel. This phenomenon is a natural artifact of the construction of the transistor and is unavoidable.

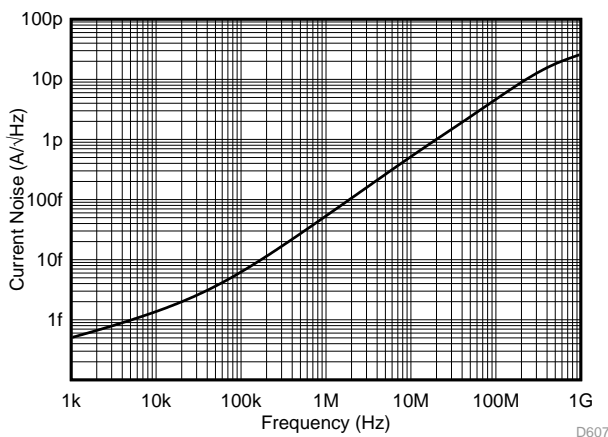

Figure 53. Input Current Noise (I_{BN} and I_{BI}) vs Frequency

9.4 Device Functional Modes

9.4.1 Split-Supply and Single-Supply Operation

The OPA858 can be configured with single-sided supplies or split-supplies as shown in [Figure 63](#). Split-supply operation using balanced supplies with the input common-mode set to ground eases lab testing because most signal generators, network analyzers, spectrum analyzers, and other lab equipment typically reference inputs and outputs to ground. Split-supply operation is preferred in systems where the signals swing around ground. However, the system requires two supply rails. In split-supply operation, the thermal pad must be connected to the negative supply.

Newer systems use a single power supply to improve efficiency and reduce the cost of the extra power supply. The OPA858 can be used with a single positive supply (negative supply at ground) with no change in performance if the input common-mode and output swing are biased within the linear operation of the device. To change the circuit from a split-supply to a single-supply configuration, level shift all the voltages by half the difference between the power supply rails. In this case, the thermal pad must be connected to ground.

9.4.2 Power-Down Mode

The OPA858 features a power-down mode to reduce the quiescent current to conserve power. [Figure 23](#) and [Figure 24](#) show the transient response of the OPA858 as the $\overline{\text{PD}}$ pin toggles between the disabled and enabled states.

The $\overline{\text{PD}}$ disable and enable threshold voltages are with reference to the negative supply. If the amplifier is configured with the positive supply at 3.3 V and the negative supply at ground, then the disable and enable threshold voltages are 0.65 V and 1.8 V, respectively. If the amplifier is configured with $\pm 1.65\text{-V}$ supplies, then the disable and enable threshold voltages are at -1 V and 0.15 V , respectively. If the amplifier is configured with $\pm 2.5\text{-V}$ supplies, then the threshold voltages are at -1.85 V and -0.7 V .

[Figure 54](#) shows the switching behavior of a typical amplifier as the $\overline{\text{PD}}$ pin is swept down from the enabled state to the disabled state. Similarly [Figure 55](#) shows the switching behavior of a typical amplifier as the $\overline{\text{PD}}$ pin is swept up from the disabled state to the enabled state. The small difference in the switching thresholds between the down sweep and the up sweep is due to the hysteresis designed into the amplifier to increase its immunity to noise on the $\overline{\text{PD}}$ pin.

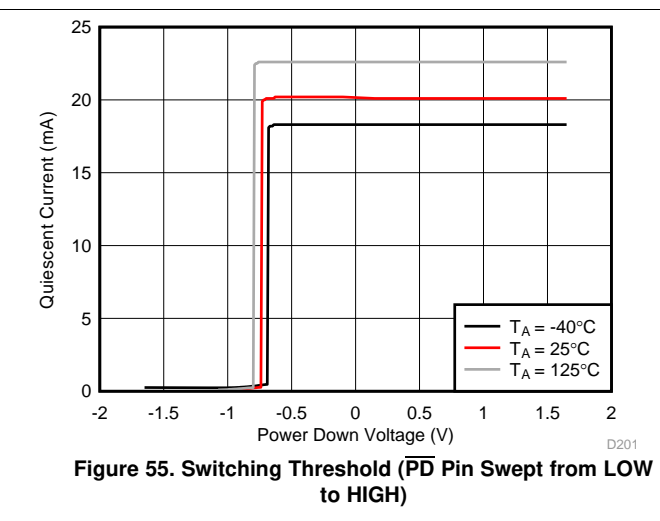
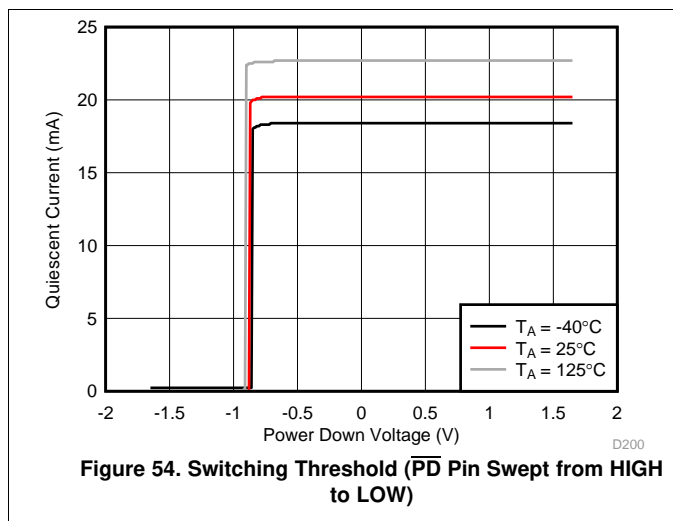

Connecting the $\overline{\text{PD}}$ pin low disables the amplifier and places the output in a high-impedance state. When the amplifier is configured as a noninverting amplifier, the feedback (R_F) and gain (R_G) resistor network form a parallel load to the output of the amplifier. To protect the input stage of the amplifier, the OPA858 uses internal, back-to-back protection diodes between the inverting and noninverting input pins as [Figure 48](#) shows. When the differential voltage between the input pins of the amplifier exceeds a diode voltage drop, an additional low-impedance path is created between the inputs.

10 Application and Implementation

NOTE

Information in the following applications sections is not part of the TI component specification, and TI does not warrant its accuracy or completeness. TI's customers are responsible for determining suitability of components for their purposes. Customers should validate and test their design implementation to confirm system functionality.

10.1 Application Information

10.1.1 Using the OPA858 as a Transimpedance Amplifier

The OPA858 design has been optimized to meet the industry's growing demand for wideband, low-noise photodiode amplifiers. The closed-loop bandwidth of a transimpedance amplifier is a function of the following:

1. The total input capacitance. This includes the photodiode capacitance, input capacitance of the amplifier (common-mode and differential capacitance) and any stray capacitance from the PCB.
2. The op amp gain bandwidth product (GBWP), and,
3. The transimpedance gain R_F .

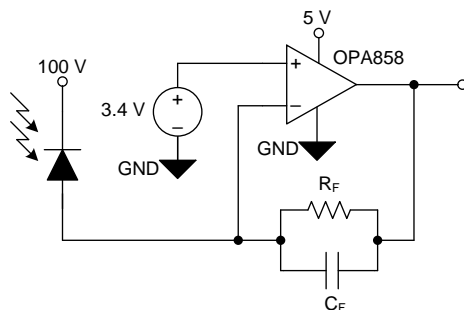
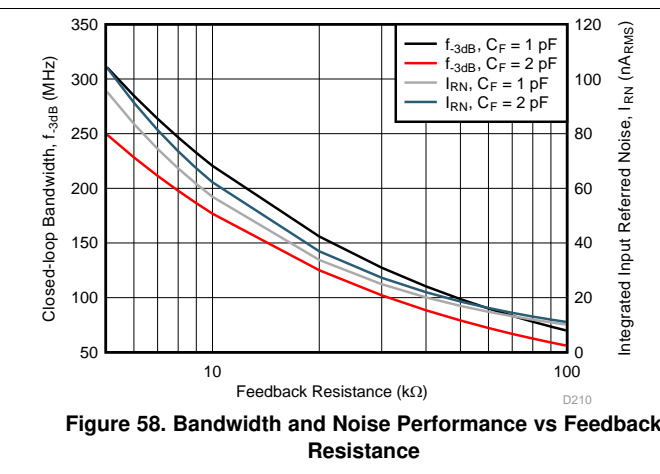
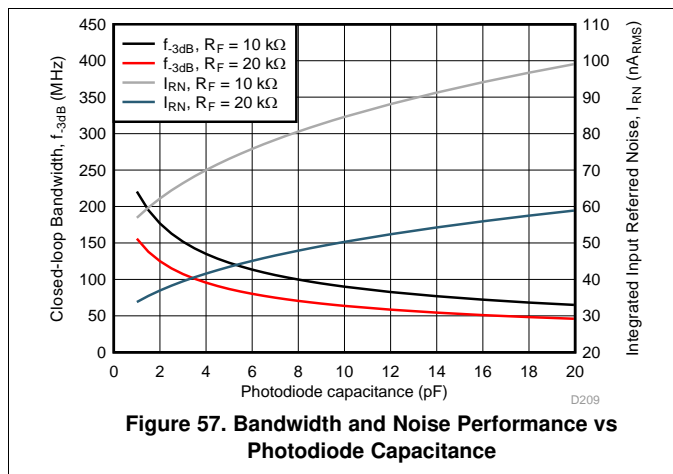

Figure 56. Transimpedance Amplifier Circuit

Figure 56 shows the OPA858 configured as a TIA with the avalanche photodiode (APD) reverse biased such that its cathode is tied to a large positive bias voltage. In this configuration the APD sources current into the op amp feedback loop so that the output swings in a negative direction relative to the input common-mode voltage. To maximize the output swing in the negative direction, the OPA858 common-mode is set close to the positive limit, 1.6 V from the positive supply rail.

The feedback resistance R_F and the input capacitance form a zero in the noise gain that results in instability if left unchecked. To counteract the effect of the zero, a pole is inserted by adding the feedback capacitor (C_F) into the noise gain transfer function. The [Transimpedance Considerations for High-Speed Amplifiers](#) application report discusses theories and equations that show how to compensate a transimpedance amplifier for a particular gain and input capacitance. The bandwidth and compensation equations from the application report are available in a Microsoft Excel™ calculator. [What You Need To Know About Transimpedance Amplifiers – Part 1](#) provides a link to the calculator.

Application Information (continued)



The equations and calculators in the application report and blog posts referenced above are used to model the bandwidth (f_{-3dB}) and noise (I_{RN}) performance of the OPA858 configured as a TIA. The resultant performance is shown in [Figure 57](#) and [Figure 58](#). The left side Y-axis shows the closed-loop bandwidth performance, while the right side of the graph shows the integrated input referred noise. The noise bandwidth to calculate I_{RN} , for a fixed R_F and C_{PD} is set equal to the f_{-3dB} frequency.

[Figure 57](#) shows the amplifier performance as a function of photodiode capacitance (C_{PD}) for $R_F = 10\text{ k}\Omega$ and $20\text{ k}\Omega$. Increasing C_{PD} decreases the closed-loop bandwidth. It is vital to reduce any stray parasitic capacitance from the PCB to maximize bandwidth. The OPA858 is designed with 0.8 pF of total input capacitance to minimize the effect on system performance.

[Figure 58](#) shows the amplifier performance as a function of R_F for $C_{PD} = 1\text{ pF}$ and 2 pF . Increasing R_F results in lower bandwidth. To maximize the signal-to-noise ratio (SNR) in an optical front-end system, maximize the gain in the TIA stage. Increasing R_F by a factor of "X" increases the signal level by "X", but only increases the resistor noise contribution by " \sqrt{X} ", thereby improving SNR.

10.2 Typical Application

The high GBWP, low input voltage noise and high slew rate of the OPA858 makes the device a viable wideband, high input impedance voltage amplifier.

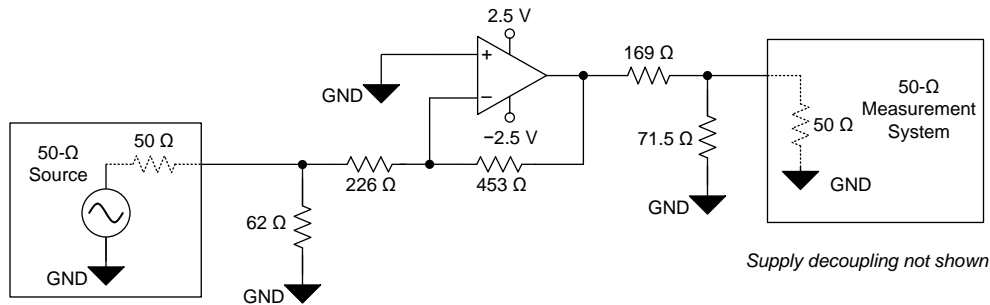

Figure 59. OPA858 in a Gain of $-2V/V$ (No Noise Gain Shaping)

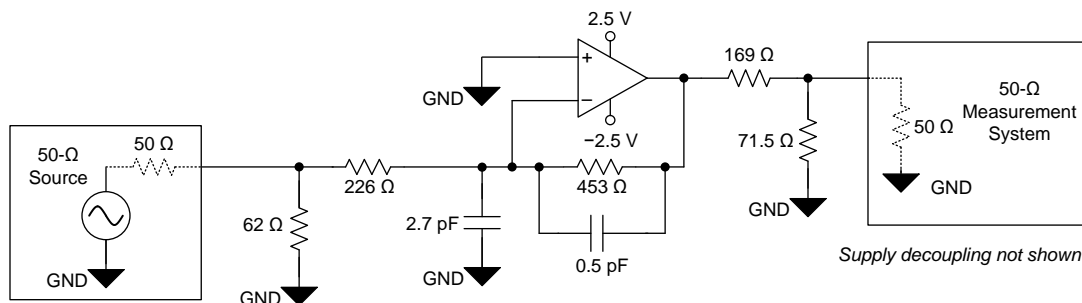

Figure 60. OPA858 in a Gain of $-2V/V$ (With Noise Gain Shaping)

10.2.1 Design Requirements

Design a high-bandwidth, high-gain, voltage amplifier with the design requirements listed in Table 1. An inverting amplifier configuration is chosen here; however, the theory is applicable to a noninverting configuration as well. In an inverting configuration the signal gain and noise gain transfer functions are not equal, unlike the noninverting configuration.

Table 1. Design Requirements

TARGET BANDWIDTH (MHz)	SIGNAL GAIN (V/V)	FEEDBACK RESISTANCE (Ω)	FREQUENCY PEAKING (dB)
> 750	-2	453	< 2

10.2.2 Detailed Design Procedure

The OPA858 is compensated to have less than 1 dB of peaking in a gain of 7 V/V. Using the device in lower gains results in increased peaking and potential instability. Figure 59 shows the OPA858 configured in a signal gain of $-2 V/V$. The DC noise gain ($1/\beta$) of the amplifier is affected by the $62\text{-}\Omega$ termination resistor and the $50\text{-}\Omega$ source resistor and is given by Equation 1. At higher frequencies the noise gain is affected by reactive elements such as inductors and capacitors. These include both discrete board components as well as printed circuit board (PCB) parasitics.

$$\text{Noise Gain} = \frac{1}{\beta} = \left(1 + \frac{453 \Omega}{226 \Omega + (62 \Omega \parallel 50 \Omega)} \right) = 2.79 \text{ V/V} = 5.04 \text{ dB} \quad (1)$$

The stability and phase margin of the amplifier depend on the loop gain of the amplifier, which is the product of the A_{OL} and the feedback factor (β) of the amplifier. The β of a negative-feedback loop system is the portion of the output signal that is fed back to the input, and in the case of an amplifier is the inverse of the noise gain. The noise gain of the amplifier at high frequencies can be increased by adding an input capacitor and a feedback capacitor as Figure 60 shows. If done carefully, increasing $1/\beta$ improves the phase margin just as any amplifier is more stable in a high gain configuration versus a unity-gain buffer configuration. The modified network with the added capacitors alters the high-frequency noise gain, but does not alter the signal gain. The [AN-1604 Decompensated Operational Amplifiers](#) application report provides a detailed analysis of noise gain-shaping techniques for decompensated amplifiers and shows how to choose external resistors and capacitor values.

Figure 61 shows the uncompensated frequency response of the OPA858 configured as shown in Figure 59. Without any added noise gain shaping components, the OPA858 shows approximately 13 dB of peaking.

Figure 62 shows the noise gain compensated frequency response of the OPA858 configured as shown in Figure 60. The noise gain shaping elements reduce the peaking to less than 1.5 dB. The 2.7-pF input capacitor, the input capacitance of the amplifier, the gain resistor, and the feedback resistor create a zero in the noise gain at a frequency f , as Equation 2 shows.

$$f = \frac{1}{2\pi(R_F \parallel R_G)C_{IN}}$$

where

- R_F is the feedback resistor
- R_G is the input or gain resistor (includes the effect of the source and termination resistor)
- C_{IN} is the total input capacitance, which includes the external 2.7-pF capacitor, the amplifier input capacitance, and any parasitic PCB capacitance. (2)

The zero in Equation 2 increases the noise gain at higher frequencies, which is important when compensating a decompensated amplifier. However, the noise gain zero reduces the loop gain phase which results in a lower phase margin. To counteract the phase reduction due to the noise gain zero, add a pole to the noise gain curve by inserting the 0.5-pF feedback capacitor. The pole occurs at a frequency shown in Equation 3. The noise gain pole and zero locations must be selected so that the rate-of-closure between the magnitude curves of A_{OL} and $1/\beta$ is approximately 20 dB. To ensure this, the noise gain pole must occur before the $1/\beta$ magnitude curve intersects the A_{OL} magnitude curve. In other words, the noise gain pole must occur before $|A_{OL}| = |1/\beta|$. The point at which the two curves intersect is known as the loop gain crossover frequency.

$$f = \frac{1}{2\pi R_F C_F}$$

where

- C_F is the feedback capacitor (includes any added PCB parasitic) (3)

For more information on op amp stability, watch the [TI Precision Lab series on stability](#) video.

10.2.3 Application Curves

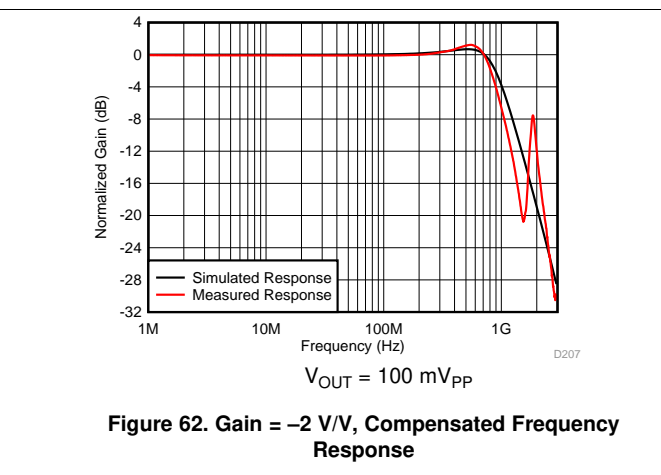
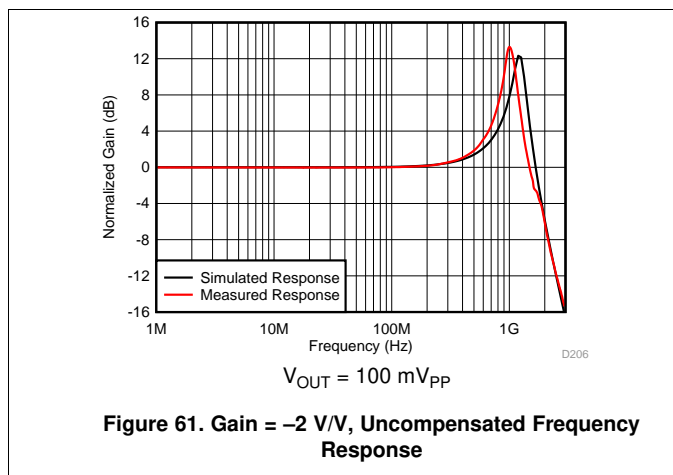

11 Power Supply Recommendations

The OPA858 operates on supplies from 3.3 V to 5.25 V. The OPA858 operates on single-sided supplies, split and balanced bipolar supplies, and unbalanced bipolar supplies. Because the OPA858 does not feature rail-to-rail inputs or outputs, the input common-mode and output swing ranges are limited at 3.3-V supplies.

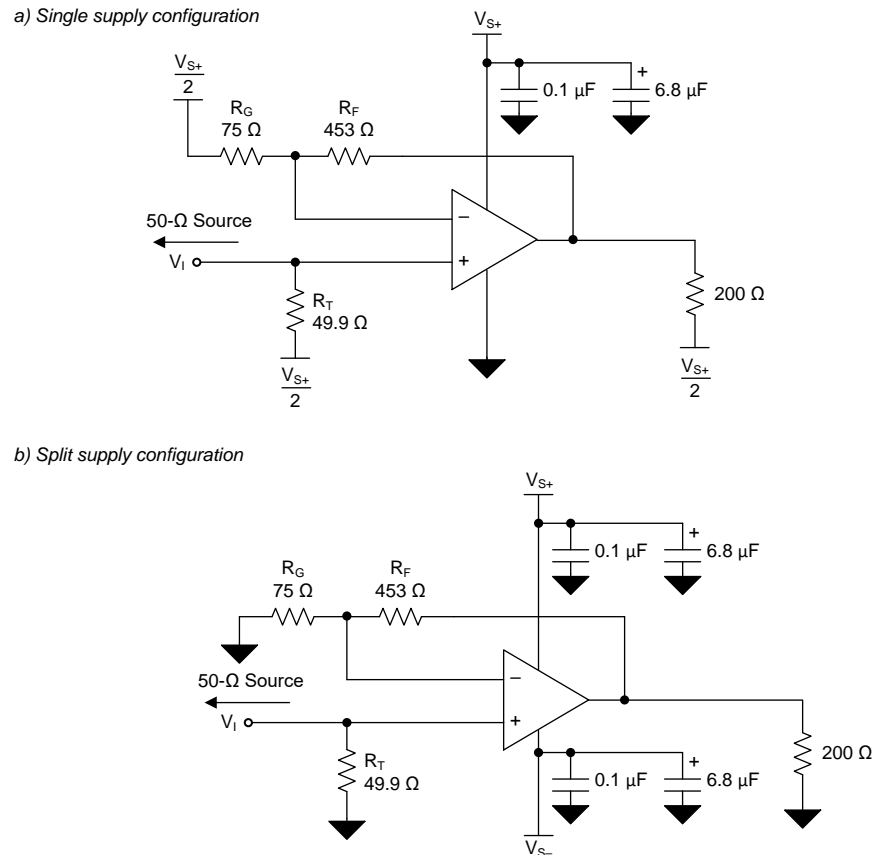

Figure 63. Split and Single Supply Circuit Configuration

12 Layout

12.1 Layout Guidelines

Achieving optimum performance with a high-frequency amplifier like the OPA858 requires careful attention to board layout parasitics and external component types. Recommendations that optimize performance include:

1. Minimize parasitic capacitance from the signal I/O pins to AC ground. Parasitic capacitance on the output and inverting input pins can cause instability. To reduce unwanted capacitance, TI recommends cutting out the power and ground traces underneath the signal input and output pins. Otherwise, ground and power planes must be unbroken elsewhere on the board. When configuring the amplifier as a TIA, if the required feedback capacitor is under 0.15 pF, consider using two series resistors, each of half the value of a single resistor in the feedback loop to minimize the parasitic capacitance from the resistor.
2. Minimize the distance (less than 0.25") from the power-supply pins to high-frequency bypass capacitors. Use high quality, 100-pF to 0.1- μ F, C0G and NPO-type decoupling capacitors with voltage ratings at least three times greater than the amplifiers maximum power supplies to ensure that there is a low-impedance path to the amplifiers power-supply pins across the amplifiers gain bandwidth specification. At the device pins, do not allow the ground and power plane layout to be in close proximity to the signal I/O pins. Avoid narrow power and ground traces to minimize inductance between the pins and the decoupling capacitors. The power-supply connections must always be decoupled with these capacitors. Larger (2.2- μ F to 6.8- μ F) decoupling capacitors, effective at lower frequency, must be used on the supply pins. These are placed further from the device and are shared among several devices in the same area of the PC board.
3. **Careful selection and placement of external components preserves the high-frequency performance of the OPA858** . Use low-reactance resistors. Surface-mount resistors work best and allow a tighter overall layout. Never use wirewound resistors in a high-frequency application. Because the output pin and inverting input pin are the most sensitive to parasitic capacitance, always position the feedback and series output resistor, if any, as close to the output pin as possible. Place other network components (such as noninverting input termination resistors) close to the package. Even with a low parasitic capacitance shunting the external resistors, high resistor values create significant time constants that can degrade performance. When configuring the OPA858 as a voltage amplifier, keep resistor values as low as possible and consistent with load driving considerations. Decreasing the resistor values keeps the resistor noise terms low and minimizes the effect of the parasitic capacitance. However, lower resistor values increase the dynamic power consumption because R_F and R_G become part of the output load network of the amplifier.

12.2 Layout Example

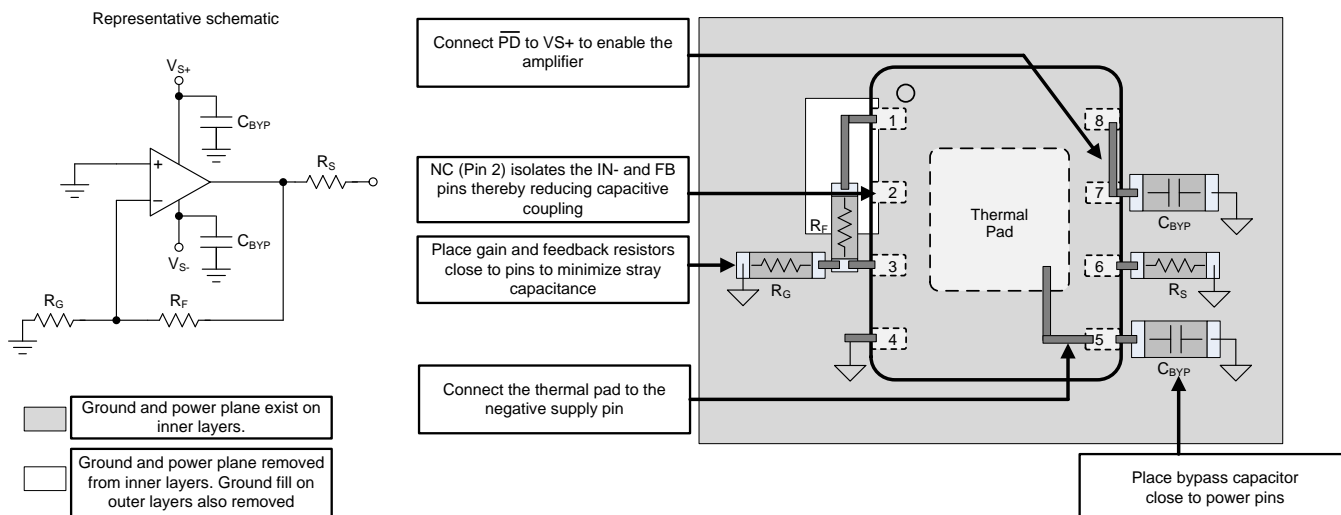

Figure 64. Layout Recommendation

Layout Example (continued)

When configuring the OPA858 as a transimpedance amplifier additional care must be taken to minimize the inductance between the avalanche photodiode (APD) and the amplifier. Always place the photodiode on the same side of the PCB as the amplifier. Placing the amplifier and the APD on opposite sides of the PCB increases the parasitic effects due to via inductance. APD packaging can be quite large which often requires the APD to be placed further away from the amplifier than ideal. The added distance between the two device results in increased inductance between the APD and op amp feedback network as shown in [Figure 65](#). The added inductance is detrimental to a decompensated amplifiers stability since it isolates the APD capacitance from the noise gain transfer function. The noise gain is given by [Equation 4](#). The added PCB trace inductance between the feedback network increases the denominator in [Equation 4](#) thereby reducing the noise gain and the phase margin. In cases where a leaded APD in a TO can is used inductance should be further minimized by cutting the leads of the TO can as short as possible.

The layout shown in [Figure 65](#) can be improved by following some of the guidelines shown in [Figure 66](#). The two key rules to follow are:

- Add an isolation resistor R_{ISO} as close as possible to the inverting input of the amplifier. Select the value of R_{ISO} to be between $10\ \Omega$ and $20\ \Omega$. The resistor dampens the potential resonance caused by the trace inductance and the amplifiers internal capacitance.
- Close the loop between the feedback elements (R_F and C_F) and R_{ISO} as close to the APD pins as possible. This ensures a more balanced layout and reduces the inductive isolation between the APD and the feedback network.

$$\text{Noise Gain} = \left(1 + \frac{Z_F}{Z_{IN}} \right)$$

where

- Z_F is the total impedance of the feedback network.
- Z_{IN} is the total impedance of the input network.

(4)

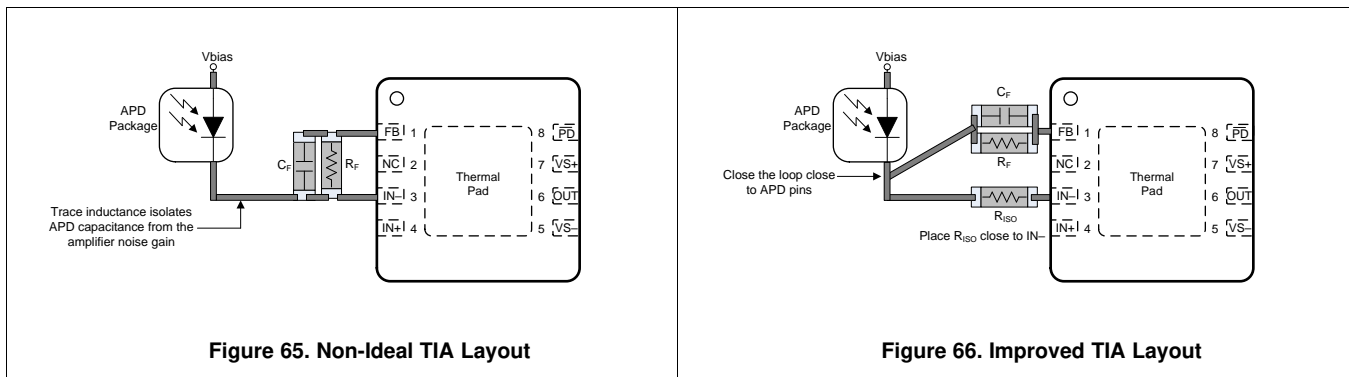

13 Device and Documentation Support

13.1 Receiving Notification of Documentation Updates

To receive notification of documentation updates, navigate to the device product folder on ti.com. In the upper right corner, click on *Alert me* to register and receive a weekly digest of any product information that has changed. For change details, review the revision history included in any revised document.

13.2 Community Resources

The following links connect to TI community resources. Linked contents are provided "AS IS" by the respective contributors. They do not constitute TI specifications and do not necessarily reflect TI's views; see TI's [Terms of Use](#).

TI E2E™ Online Community *TI's Engineer-to-Engineer (E2E) Community*. Created to foster collaboration among engineers. At e2e.ti.com, you can ask questions, share knowledge, explore ideas and help solve problems with fellow engineers.

Design Support *TI's Design Support* Quickly find helpful E2E forums along with design support tools and contact information for technical support.

13.3 Trademarks

E2E is a trademark of Texas Instruments.
is a trademark of ~Microsoft Corporation.

13.4 Electrostatic Discharge Caution



This integrated circuit can be damaged by ESD. Texas Instruments recommends that all integrated circuits be handled with appropriate precautions. Failure to observe proper handling and installation procedures can cause damage.

ESD damage can range from subtle performance degradation to complete device failure. Precision integrated circuits may be more susceptible to damage because very small parametric changes could cause the device not to meet its published specifications.

13.5 Glossary

[SLYZ022](#) — *TI Glossary*.

This glossary lists and explains terms, acronyms, and definitions.

14 Mechanical, Packaging, and Orderable Information

The following pages include mechanical, packaging, and orderable information. This information is the most current data available for the designated devices. This data is subject to change without notice and revision of this document. For browser-based versions of this data sheet, refer to the left-hand navigation.

PACKAGING INFORMATION

Orderable Device	Status (1)	Package Type	Package Drawing	Pins	Package Qty	Eco Plan (2)	Lead finish/ Ball material (6)	MSL Peak Temp (3)	Op Temp (°C)	Device Marking (4/5)	Samples
OPA858IDSGR	ACTIVE	WSON	DSG	8	3000	RoHS & Green	NIPDAU	Level-1-260C-UNLIM	-40 to 125	X858	Samples
OPA858IDSGT	ACTIVE	WSON	DSG	8	250	RoHS & Green	NIPDAU	Level-1-260C-UNLIM	-40 to 125	X858	Samples

(1) The marketing status values are defined as follows:

ACTIVE: Product device recommended for new designs.

LIFEBUY: TI has announced that the device will be discontinued, and a lifetime-buy period is in effect.

NRND: Not recommended for new designs. Device is in production to support existing customers, but TI does not recommend using this part in a new design.

PREVIEW: Device has been announced but is not in production. Samples may or may not be available.

OBSOLETE: TI has discontinued the production of the device.

(2) **RoHS:** TI defines "RoHS" to mean semiconductor products that are compliant with the current EU RoHS requirements for all 10 RoHS substances, including the requirement that RoHS substance do not exceed 0.1% by weight in homogeneous materials. Where designed to be soldered at high temperatures, "RoHS" products are suitable for use in specified lead-free processes. TI may reference these types of products as "Pb-Free".

RoHS Exempt: TI defines "RoHS Exempt" to mean products that contain lead but are compliant with EU RoHS pursuant to a specific EU RoHS exemption.

Green: TI defines "Green" to mean the content of Chlorine (Cl) and Bromine (Br) based flame retardants meet JS709B low halogen requirements of <=1000ppm threshold. Antimony trioxide based flame retardants must also meet the <=1000ppm threshold requirement.

(3) MSL, Peak Temp. - The Moisture Sensitivity Level rating according to the JEDEC industry standard classifications, and peak solder temperature.

(4) There may be additional marking, which relates to the logo, the lot trace code information, or the environmental category on the device.

(5) Multiple Device Markings will be inside parentheses. Only one Device Marking contained in parentheses and separated by a "~" will appear on a device. If a line is indented then it is a continuation of the previous line and the two combined represent the entire Device Marking for that device.

(6) Lead finish/Ball material - Orderable Devices may have multiple material finish options. Finish options are separated by a vertical ruled line. Lead finish/Ball material values may wrap to two lines if the finish value exceeds the maximum column width.

Important Information and Disclaimer:The information provided on this page represents TI's knowledge and belief as of the date that it is provided. TI bases its knowledge and belief on information provided by third parties, and makes no representation or warranty as to the accuracy of such information. Efforts are underway to better integrate information from third parties. TI has taken and continues to take reasonable steps to provide representative and accurate information but may not have conducted destructive testing or chemical analysis on incoming materials and chemicals. TI and TI suppliers consider certain information to be proprietary, and thus CAS numbers and other limited information may not be available for release.

In no event shall TI's liability arising out of such information exceed the total purchase price of the TI part(s) at issue in this document sold by TI to Customer on an annual basis.

OTHER QUALIFIED VERSIONS OF OPA858 :

- Automotive : [OPA858-Q1](#)

NOTE: Qualified Version Definitions:

- Automotive - Q100 devices qualified for high-reliability automotive applications targeting zero defects

TAPE AND REEL INFORMATION

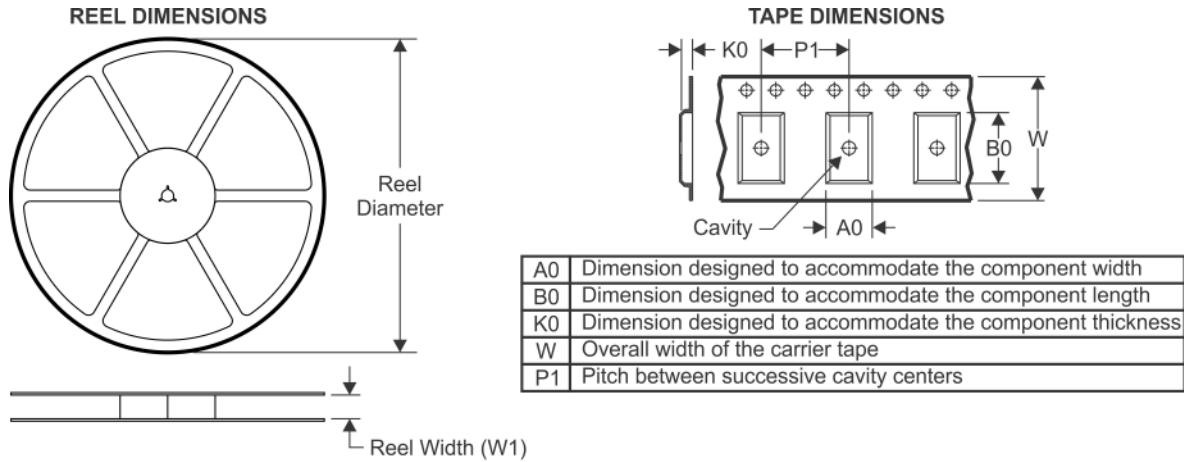

QUADRANT ASSIGNMENTS FOR PIN 1 ORIENTATION IN TAPE

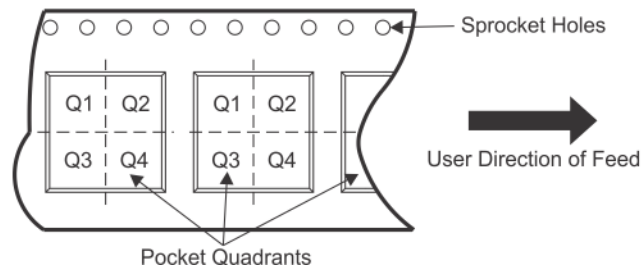

*All dimensions are nominal

Device	Package Type	Package Drawing	Pins	SPQ	Reel Diameter (mm)	Reel Width W1 (mm)	A0 (mm)	B0 (mm)	K0 (mm)	P1 (mm)	W (mm)	Pin1 Quadrant
OPA858IDSGR	WSON	DSG	8	3000	180.0	8.4	2.3	2.3	1.15	4.0	8.0	Q2
OPA858IDSGT	WSON	DSG	8	250	180.0	8.4	2.3	2.3	1.15	4.0	8.0	Q2

TAPE AND REEL BOX DIMENSIONS

*All dimensions are nominal

Device	Package Type	Package Drawing	Pins	SPQ	Length (mm)	Width (mm)	Height (mm)
OPA858IDSGR	WSON	DSG	8	3000	210.0	185.0	35.0
OPA858IDSGT	WSON	DSG	8	250	210.0	185.0	35.0

GENERIC PACKAGE VIEW

DSG 8

WSON - 0.8 mm max height

2 x 2, 0.5 mm pitch

PLASTIC SMALL OUTLINE - NO LEAD

This image is a representation of the package family, actual package may vary.
Refer to the product data sheet for package details.

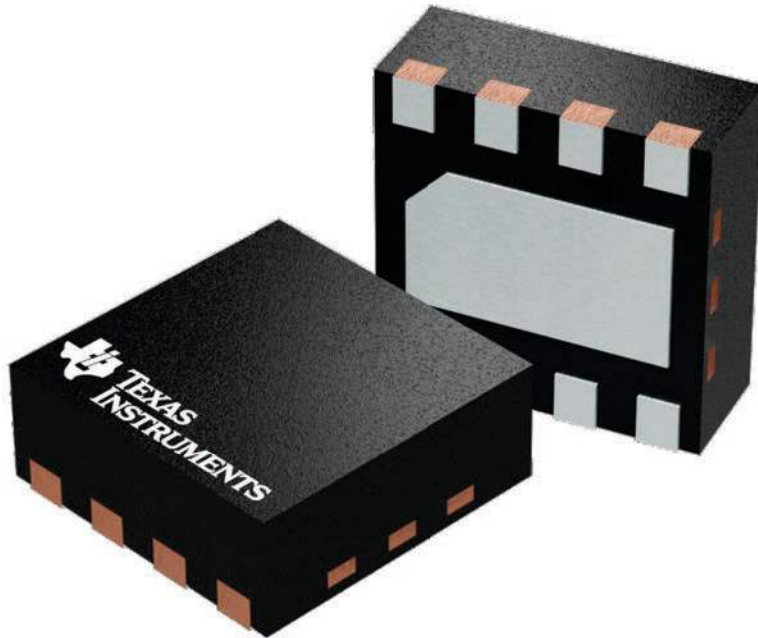

4224783/A

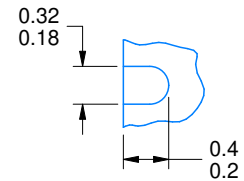
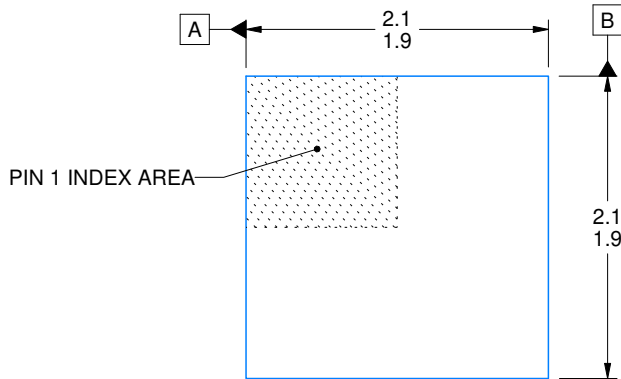
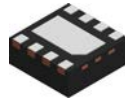

ALTERNATIVE TERMINAL SHAPE TYPICAL

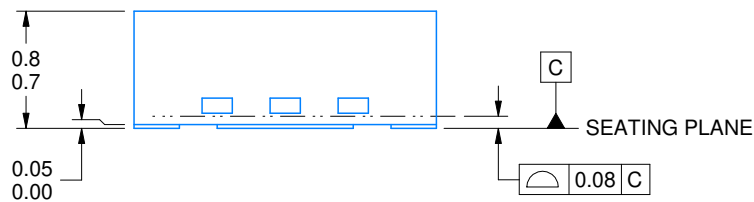

SIDE WALL METAL THICKNESS DIM A	
OPTION 1	OPTION 2
0.1	0.2

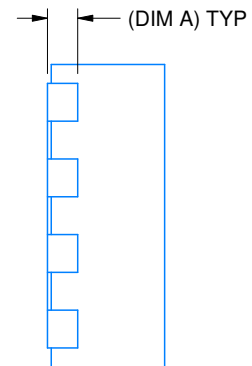
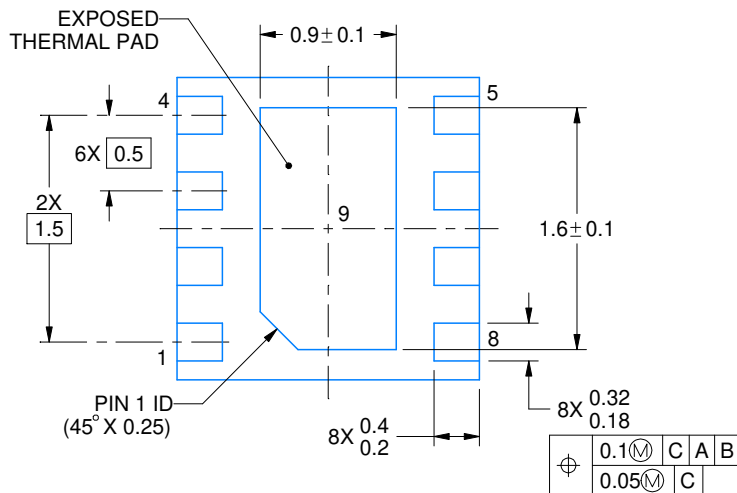

4218900/E 08/2022

NOTES:

1. All linear dimensions are in millimeters. Any dimensions in parenthesis are for reference only. Dimensioning and tolerancing per ASME Y14.5M.
2. This drawing is subject to change without notice.
3. The package thermal pad must be soldered to the printed circuit board for thermal and mechanical performance.

EXAMPLE STENCIL DESIGN

DSG0008A

WSON - 0.8 mm max height

PLASTIC SMALL OUTLINE - NO LEAD

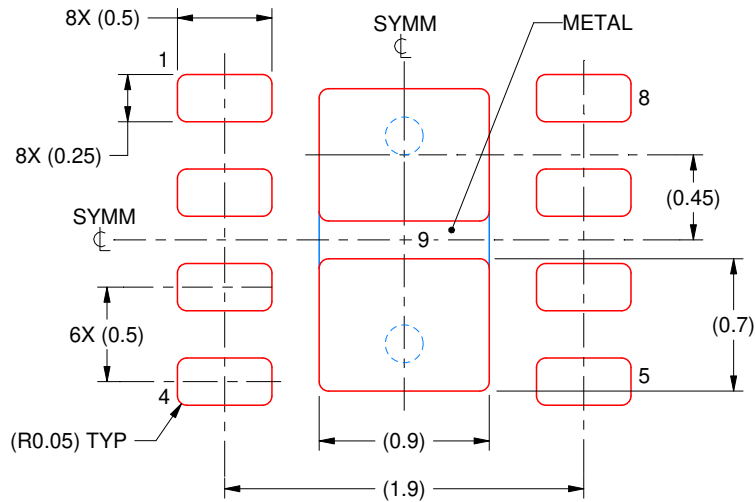

SOLDER PASTE EXAMPLE
BASED ON 0.125 mm THICK STENCIL

EXPOSED PAD 9:
87% PRINTED SOLDER COVERAGE BY AREA UNDER PACKAGE
SCALE:25X

4218900/E 08/2022

NOTES: (continued)

6. Laser cutting apertures with trapezoidal walls and rounded corners may offer better paste release. IPC-7525 may have alternate design recommendations.

IMPORTANT NOTICE AND DISCLAIMER

TI PROVIDES TECHNICAL AND RELIABILITY DATA (INCLUDING DATA SHEETS), DESIGN RESOURCES (INCLUDING REFERENCE DESIGNS), APPLICATION OR OTHER DESIGN ADVICE, WEB TOOLS, SAFETY INFORMATION, AND OTHER RESOURCES "AS IS" AND WITH ALL FAULTS, AND DISCLAIMS ALL WARRANTIES, EXPRESS AND IMPLIED, INCLUDING WITHOUT LIMITATION ANY IMPLIED WARRANTIES OF MERCHANTABILITY, FITNESS FOR A PARTICULAR PURPOSE OR NON-INFRINGEMENT OF THIRD PARTY INTELLECTUAL PROPERTY RIGHTS.

These resources are intended for skilled developers designing with TI products. You are solely responsible for (1) selecting the appropriate TI products for your application, (2) designing, validating and testing your application, and (3) ensuring your application meets applicable standards, and any other safety, security, regulatory or other requirements.

These resources are subject to change without notice. TI grants you permission to use these resources only for development of an application that uses the TI products described in the resource. Other reproduction and display of these resources is prohibited. No license is granted to any other TI intellectual property right or to any third party intellectual property right. TI disclaims responsibility for, and you will fully indemnify TI and its representatives against, any claims, damages, costs, losses, and liabilities arising out of your use of these resources.

TI's products are provided subject to [TI's Terms of Sale](#) or other applicable terms available either on ti.com or provided in conjunction with such TI products. TI's provision of these resources does not expand or otherwise alter TI's applicable warranties or warranty disclaimers for TI products.

TI objects to and rejects any additional or different terms you may have proposed.

Mailing Address: Texas Instruments, Post Office Box 655303, Dallas, Texas 75265
Copyright © 2022, Texas Instruments Incorporated